

COASTAL STRUCTURES HANDBOOK SERIES

CIRCULATING COPY
Sea Grant Program

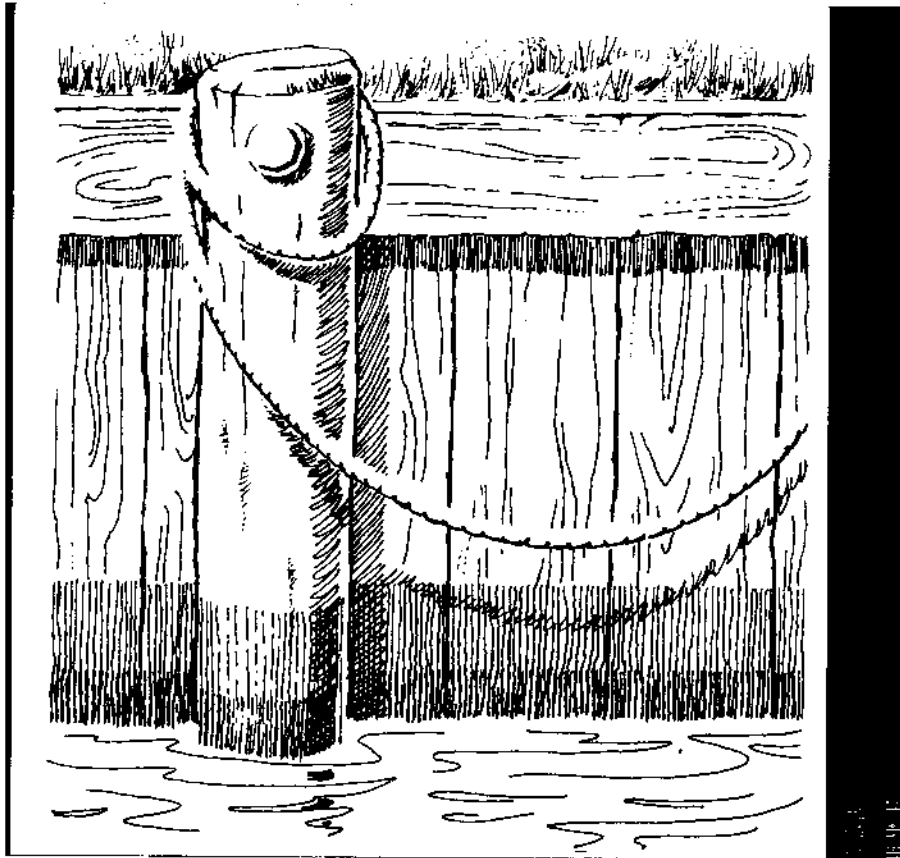

Docks, Piers and Wharves: A Design Guide

William S. Burgess, Jr.
and Fred H. Kulhawy

NATIONAL SEA GRANT DEPT.
PELL LIBRARY BUILDING
URI, NARRAGANSETT BAY CAMPUS
NARRAGANSETT, RI 02882

NEW YORK SEA GRANT INSTITUTE

**FIRST
IMPRESSIONS**

This manual is part of the Coastal Structures Handbook Series. The series is being prepared for the New York Sea Grant Institute by the Geotechnical Engineering group at Cornell University, coordinated by Fred H. Kulhawy.

COVER DESIGN: DICK GORDON

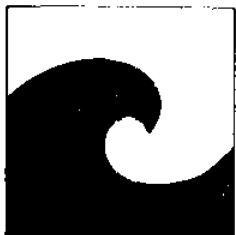

New York Sea Grant Institute
State University of New York
and Cornell University
37 Elk Street
Albany, New York 12246

FIRST IMPRESSIONS ARE SELECTED UNPUBLISHED SEA GRANT RESEARCH PAPERS AVAILABLE FOR THE PRICE OF PHOTOCOPYING.

LOAN COPY ONLY

DOCKS, PIERS AND WHARVES:

A DESIGN GUIDE

by

William S. Burgess, Jr., and Fred H. Kulhawy

Report

to

New York Sea Grant Institute
Albany, New York

by

School of Civil and Environmental Engineering
Cornell University
Ithaca, New York

January, 1983

NATIONAL SEA GRANT DEPOSITORY
PELL LIBRARY BUILDING
URI, NARRAGANSETT BAY CAMPUS
NARRAGANSETT, RI 02882

This report will constitute a chapter in a manual entitled, "Analysis Design and Construction of Coastal Structures". This manual is being prepared for the New York Sea Grant Institute by the Geotechnical Engineering Group at Cornell University, and is being edited by Fred H. Kulhawy and Philip L.-F. Liu.

PREFACE

The analysis, design and construction of coastal structures is of great concern to a broad cross-section of the population living near major fresh and salt water bodies. Realizing this concern, the New York Sea Grant Institute instituted a project to develop a manual to assist a variety of user groups in addressing the problems associated with the development of coastal structures and coastal facilities. Although the engineering community will find the manual to be of use, the focus of this manual has been to develop a simplified user's guide which focuses on the analysis, design and construction of coastal structures. The emphasis has been on understanding the structures and their behavior, minimizing higher level mathematics, and presenting design charts and design examples for smaller scale structures, typical of those of importance to a small community and the individual homeowner. Large scale developments should be handled by design professionals with expertise in the field.

This project was initiated in late 1977 by the New York Sea Grant Institute and has been developed by the School of Civil and Environmental Engineering at Cornell University. The project was initiated by Drs. Fred H. Kulhawy and Dwight A. Sangrey. Dr. Sangrey left Cornell before much progress was made, and subsequent work has been supervised by Drs. Fred H. Kulhawy and Philip L.-F. Liu.

Under the auspices of this project, the following reports have been prepared and submitted to New York Sea Grant:

1. "Regulatory Processes in Coastal Structures Construction", August 1979, by Susan A. Ronan, with the assistance of Dwight A. Sangrey

2. "Coastal Construction Materials", November 1979, by Walter D. Hubbell and Fred H. Kulhawy
3. "Environmental Loads in Coastal Construction", November 1979, by Walter D. Hubbell and Fred H. Kulhawy
4. "Analysis, Design and Construction of Pile Foundations in the Coastal Environment", April 1981, by Francis K.-P. Cheung and Fred H. Kulhawy
5. "Breakwaters, Jetties and Groins: A Design Guide", March 1982, by Laurie A. Ehrlich and Fred H. Kulhawy
6. "Analysis, Design and Construction of Bulkheads in the Coastal Environment", May 1982, by Thomas M. Saczynski and Fred H. Kulhawy

This report is the seventh submitted to date.

ABSTRACT

Docks, piers and wharves are inner harbor structures that provide a link between land and water modes of transportation. This study presents guidelines for the planning, layout and design of these structures while focusing on small craft recreational applications.

The planning and layout considerations for docks, piers and wharves are discussed while recognizing that these topics are correctly a subset of overall harbor planning. Design loads and material properties are addressed to provide a basis for structural analysis and design.

Three broad categories of structural type are presented including solid fill, fixed and floating structures. Each structural type is described by component part with design considerations and recommendations based on practical, sound engineering procedures. Design considerations for utilities, special services, and dredging operations are also presented.

TABLE OF CONTENTS

	<u>Page</u>
PREFACE	ii
ABSTRACT	iv
TABLE OF CONTENTS	v
LIST OF TABLES	viii
LIST OF ILLUSTRATIONS	ix
LIST OF SYMBOLS	xiv
LIST OF CONVERSIONS	xvi
CHAPTER 1 INTRODUCTION	1
CHAPTER 2 PLANNING AND LAYOUT OF DOCKS, PIERS AND WHARVES	7
2.1 Harbor Type and Location	7
2.2 Choice of Structural Type	12
2.3 Environmental Impact	12
2.4 Legal Concerns	13
2.5 Layout and Geometry of Docks, Piers and Wharves	13
2.6 Summary	22
CHAPTER 3 SUMMARY OF DESIGN LOADS	24
3.1 Design Wave and Wave Forces	24
3.2 Wind Loads	32
3.3 Current Loads	42
3.4 Boat Impact	47
3.5 Ice Loads	53
3.6 Dead and Live Loads	54
3.7 Catastrophic Loads	57
3.8 Combination of Loads	58
3.9 Summary	59

	<u>Page</u>
CHAPTER 4 ENGINEERING PROPERTIES OF MATERIALS	60
4.1 Concrete	61
4.2 Steel	73
4.3 Wood	73
4.4 Aluminum	95
4.5 Wrought Iron	97
4.6 Summary	99
CHAPTER 5 SOLID FILL TYPE DOCKS, PIERS AND WHARVES	101
5.1 Wall Types	101
5.2 Selection of Wall Type	114
5.3 Geotechnical Design Considerations	118
5.4 Summary	129
CHAPTER 6 FIXED DOCKS, PIERS AND WHARVES	131
6.1 Structural Geometry	135
6.2 Pile Foundations	137
6.3 Selection of Pile Type	152
6.4 Design and Installation of Pile Foundations	154
6.5 Decking and Framing Design Considerations	154
6.6 Fixed Dock Moorage	176
6.7 Fixed Dock Fenders	182
6.8 Summary	187
CHAPTER 7 FLOATING DOCKS, PIERS AND WHARVES	190
7.1 Structural Geometry	193
7.2 Design Considerations for Flotation Elements	195
7.3 Selection of Float Element Type	204
7.4 Design Considerations for Float Components	206

	<u>Page</u>
7.5 Floating Dock Moorage	229
7.6 Floating Dock Fenders	229
7.7 Anchorage Systems	231
7.8 Summary	250
CHAPTER 8 UTILITIES AND SPECIAL SERVICES	253
8.1 Electrical Service	254
8.2 Sewage Pumpout and Disposal Service	258
8.3 Fresh Water Service	264
8.4 Fire Fighting Services	268
8.5 Fueling Services	273
8.6 Summary	278
CHAPTER 9 DREDGING FOR SMALL CRAFT HARBORS	279
9.1 Methods and Equipment	279
9.2 Primary and Maintenance Dredging	283
9.3 Dredged Materials and their Disposal	284
9.4 Environmental Impacts of Dredging	289
9.5 Dredging Problems	294
9.6 Summary	295
CHAPTER 10 SUMMARY AND CONCLUSIONS	297
REFERENCES	302
APPENDIX A SMALL CRAFT BERTHING FACILITIES, LAYOUT	312

LIST OF TABLES

<u>Table Number</u>		<u>Page</u>
2.1	Recommended Slip Widths for Various Slip Lengths	20
3.1	Typical Values for Gradient Height, Surface Drag Coefficient and Roughness Length	37
4.1	Concrete Design Recommendations for Marine Structures	72
4.2	Steel Alloys and Uses	74
4.3	Availability of Shapes, Plates and Bars According to ASTM Structural Steel Specifications	75
4.4	Average Specific Gravity and Average Weight for Commercially Important Timber Species	80
4.5	Average Change in Clear Wood Strength Properties for a 1-percent Change in Moisture Content Below Fiber Saturation Point	83
4.6	Shrinkage Values of Wood	89
4.7	Properties of Commercial Aluminum	98
9.1	Mechanical and Hydraulic Dredges	280-281

LIST OF ILLUSTRATIONS

<u>Figure Number</u>		<u>Page</u>
1.1	Dock, Pier and Wharf Geometry	2
1.2	Organizational Chart of Design Considerations	5
2.1	Inland River Marina Locations	9
2.2	Mechanical Current Generator	14
2.3	Spatial Arrangement of Berthing System Components	15
2.4	Gaussian Distribution of Slip Length	17
2.5	Recommended Berth Width for Single and Double Slips	19
3.1	Horizontal Wave Force on a Floating Object	28
3.2	Small Craft Weight and Displacement Volume	29
3.3	Wave Force Adjustment for Relative Body Length	30
3.4	Isotach of Maximum Wind Velocity (mph), 30 ft (9.1 m) Above Ground, 50 Year Recurrence Period	34
3.5	Mean Wind Velocity versus Altitude	35
3.6	Mean Wind Velocity versus Profile Height	36
3.7	Horizontal Wind Pressure on a Vertical Face	39
3.8	Above Water Profile Height versus Length of Craft	40
3.9	Superposition of Waves and Harmonic Motion	43
3.10	Current Pressure versus Current Velocity	45
3.11	Underwater Profile Height versus Boat Length	46
3.12	Docking Impact Energy for Small Craft	48
3.13	Assumed Geometry for Boat Impact Analysis	50
3.14	Impact Energy Reduction Factor versus Berthing Point	51
4.1	Relation Between Durability and Water-Cement Ratio for Air-Entrained and Non-Air-Entrained Concrete	63
4.2	Relationship Between Coefficient of Permeability and Water-Cement Ratio, for Mortar and Concrete of Three Aggregate Sizes	64

<u>Figure Number</u>		<u>Page</u>
4.3	Conventional Gradation Chart for Concrete Aggregate	65
4.4	Gradation Chart for Concrete Aggregate Using Sieve Sizes to the 0.45 Power	66
4.5	Strength in Relation to Water-Cement Ratio for Air-Entrained and Non-Air-Entrained Concrete	69
4.6	Effect of Moist Curing on the Strength of Concrete	69
4.7	Temperature Dependency of Concrete Strength	70
4.8	Transverse and Tangential Sections of a Softwood	77
4.9	The Orthotropic Axes of Wood	78
4.10	Permanent Effect of Dry Heat on the Modulus of Rupture of Dry Wood	84
4.11	Load Direction in Relation to Annual Growth Ring Direction	86
4.12	Characteristic Shrinkage and Distortion of Wood Shapes Because of Annual Ring Direction	90
4.13	Adjustment of Wood Working Stresses for Load Duration	91
4.14	Experimentally Derived Creep Curve for Wood	93
4.15	Typical Fatigue Curves of Aluminum Alloys	96
5.1	Anchored Bulkhead Wall	102
5.2	Cantilevered Sheet Pile Wall	104
5.3	Typical Pile Supported "L" Wall for Weak Soils	105
5.4	Use of Gabions in Marina Construction	106
5.5	Typical Timber-Crpf Wharf	108
5.6	Cellular Sheet Pile Wharf	110
5.7	Sheet Pile Arrangement for Cellular Walls	110
5.8	Concrete Caisson Wharf	111
5.9	Relieving Platform Type Wharf	113
5.10	Effect of Wave Characteristics on Air Pressure Buildup	115

<u>Figure Number</u>		<u>Page</u>
5.11	Reduction of Air Pressure in Relation to Percentage of Air-Hole Area	116
5.12	Deep-Seated Failure of a Retaining Platform Because of Insufficient Bearing Capacity of Underlying Weak Soil	121
5.13	Granular Bedding Layer Used to Increase the Bearing Capacity of an Underlying Weak Soil	122
6.1	Dry-Stack Storage	133
6.2	Compressed Air-Ice Suppression System	134
6.3	Air Bubbler Layout	134
6.4	Fixed Pier Construction	136
6.5	High-Level Fixed Wharf Construction	136
6.6	Typical Pile Types Used in Waterfront Construction	138
6.7	Bearing and Batter Piles	140
6.8	Concrete and Tar Pile Cap	143
6.9	Molded Synthetic Pile Cap	143
6.10	Wood Batten Pile Protection	144
6.11	Timber Pile Splice Detail	145
6.12	Examples of Cast-in-Place Concrete Piles	149
6.13	Examples of Precast Concrete Piles	150
6.14	Types of Fixed Pier Bracing	158
6.15	Pile Cap Types	160
6.16	Typical Pile to Superstructure Connections	162
6.17	Prestressed, Precast Concrete Deck System	164
6.18	Proper Grain Orientation for Wood Plank Decking	165
6.19	Diagonal Deck Planking	166
6.20	Fixed Pier Gangway	169

<u>Figure Number</u>		<u>Page</u>
6.21	Finger Pier or Walkway Misalignment	171
6.22	Timber Joint Fasteners	172
6.23	Joist and Beam Hangars and Framing Anchors	174
6.24	Small Craft Berthing Arrangements	177
6.25	Hardwood Mooring Cleat	179
6.26	Line Mooring and Cleat Location for Single and Double Berths	180
6.27	Cooperative Switch-Tie System for a Double Berth	181
6.28	Traveling Iron	183
6.29	Vertical Tube Fender	185
6.30	Vertical Fender Pile	186
6.31	Typical Wood Pile Dolphins	188
7.1	Floating Covered Berths	192
7.2	Floating Dock Indicating Suggested Freeboard	194
7.3	Floating Dock Structural Types	196
7.4	Floating Dock Design for Pontoon Location	209
7.5	Timber Frame and Bearing Boards above Premolded Styrofoam Floats	211
7.6	Insert and Through-Rod Concrete Pontoon Assemblies	213
7.7	Stringer Detail on a Lightweight Shell	215
7.8	Floating Dock Braces	217
7.9	Crossties and Struts Used to Strengthen Floating Pier Decks	220
7.10	Deck Framing Stiffened with a Torque Pipe	221
7.11	Floating Dock Gangway	223
7.12	Wheel Guided Gangway with Apron Plate	224
7.13	Gangway Counterbalance System	225

<u>Figure Number</u>		<u>Page</u>
7.14	Truss Supported Gangways	226
7.15	Crosslocked Connection of Finger and Headwalk Stringers	228
7.16	Hinge Connectors	230
7.17	Floating Dock Fender	232
7.18	Anchor Pile Location	235
7.19	Pile Yokes	237
7.20	Pile Rollers	239
7.21	Traveling Iron Guide	241
7.22	T-Bar Guide	241
7.23	Pipe Strut or Stiff Arm Anchorage	242
7.24	Deepwater Cable Anchorage of Floating Pier	244
7.25	Drawdown Adjustable Anchorage	245
7.26	Soft Ground Anchor Types	246
7.27	Cable Anchorage of a Floating Dock	248
7.28	Penetration and Keying of a Propellant-Embedded Anchor	249
7.29	Submerged Crossties	251
8.1	Location of Electrical Utilities	259
8.2	Location of Fresh Water Service	269
8.3	Fuel Dock Locations	277
9.1	Beach Nourishment and Sediment Bypassing	287
9.2	Behavior of Dredged Material Released From a Scow	292

LIST OF SYMBOLS

English Letters

A_{c1}	Above-water profile Area
A_{c2}	Below-water profile Area
D_r	Relative Density
E	Energy
F_c	Current Force
F_u	Tensile Stress
F_{w1}	Wave Force
F_{w2}	Wind Force
F_y	Minimum Yield Stress
g	Constant of Gravitational Acceleration
h	Above-water profile height
h_u	Underwater profile height
k	Stiffness
K_b	Impact Energy Reduction Factor
KE	Kinetic Energy
K_q	Coefficient of Permeability
L, ℓ	Length
L_w	Wave Length
P	Body Length Adjustment Factor
P_c	Current Pressure
P_w	Wind Pressure
V_B	Velocity of Boat Normal to Dock
V_c	Current Velocity
V_d	Displacement Volume

\bar{V}_w	Mean Wind Velocity
\bar{V}_{wl}	Measured Wind Velocity
W/C	Water-Cement Ratio
W_{min}	Minimum Weight of Boat
Z	Altitude
Z_1	Standard altitude for Wind Velocity Measurements (usually 30 ft or 9.1 m)
z_0	Roughness Length
z_g	Wind Velocity Gradient Height

Greek Letters

Δ	Deformation or Deflection
γ	In-site Soil Density
γ_0	Minimum Density of Soil in Laboratory
γ_m	Maximum Density of Soil in Laboratory
γ_w	Density of Water

LIST OF CONVERSIONS

<u>To Convert From</u>	<u>To</u>	<u>Multiply By</u>
°F	°C	$^{\circ}\text{C} = (5/9)(^{\circ}\text{F} - 32)$
foot	meter	0.3048
inch	millimeter	25.4
pound	Newton	4.448
lb/ft	kN/m	0.0146
lb/ft ²	kN/m ²	0.0479
lb/ft ³	kN/m ³	0.1571
lb/in ²	kN/m ²	6.895

CHAPTER 1

INTRODUCTION

Docks, piers, and wharves are types of coastal structures intended to provide a link between land and water modes of transportation. With respect to the recreational marinas which are the focus of this study, water transportation refers to small craft such as sailboats, open-hulled power boats, and light cruisers. These vessels are often large enough to preclude launching by trailer, hoist, or forklift with each outing. In addition to convenient access, dock, pier, or wharf structures must also provide mooring or tie-up facilities that afford adequate protection from environmental loads.

The term "dock" is defined with some difficulty since it may refer either to the area of water between two landing piers, or to the landing pier proper (Webster's, 1976). According to Quinn (1972), a "dock" is a general term used to describe a marine structure used for the mooring of vessels, or for the transfer of passengers and cargo. Accordingly, a dock may consist of various arrangements of wharves or piers which are defined as follows: a "wharf" is a dock which parallels and is generally contiguous with the shore, while a "pier" projects out into the harbor basin. The primary functional difference is that a pier may be approached from both sides, while a wharf only has one side open to the water. Simple examples of these structures are illustrated in Figure 1.1. Several other terms are commonly used in literature concerning small craft harbor facilities. A "marginal wharf" is one that lies along the border of a harbor, and along it runs the "marginal walkway". The

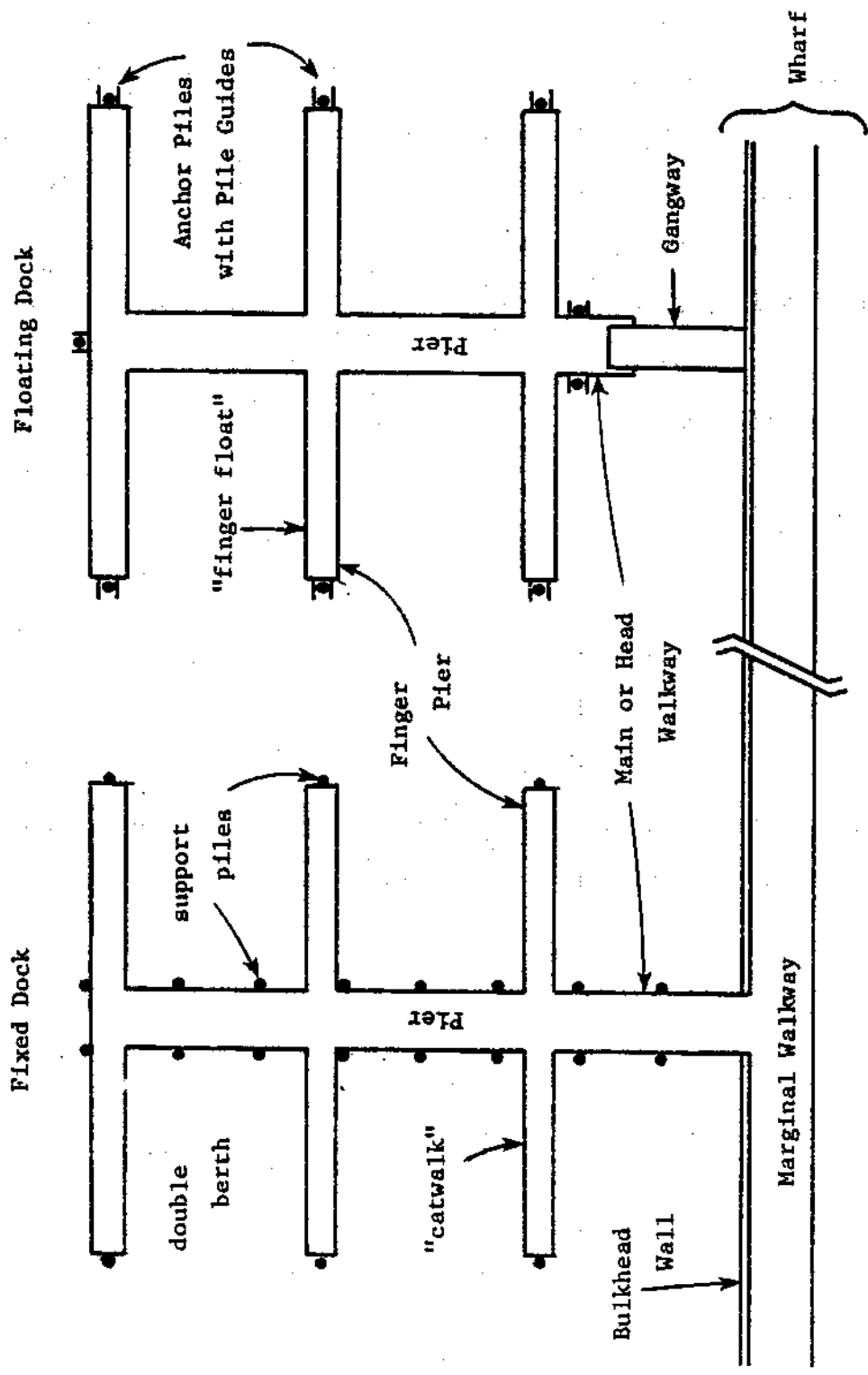

Figure 1.1 Dock, Pier and Wharf Geometry

dock surface of a pier that extends out from the shore is called the "main walk" or "headwalk". As indicated in Figure 1.1, berthed craft are separated by "finger piers" which are known as "catwalks" in the case of fixed dock structures, and "finger floats" for the corresponding floating docks.

There are three broad categories of structural type used in the construction of docks, including solid fill, fixed or pile supported, and floating or pontoon supported. It would be unusual however, for the typical small craft marina to consist of only one structural type. The most common form of marginal wharf is the anchored bulkhead which also serves to retain the surrounding soil. Floating berthing arrangements are often accessed by a fixed pier approach.

In the past, the analysis and design of these structures has been based on the local experience of the owner and/or contractor. While such procedures may have resulted in some savings in terms of first cost, the quality of the finished product was often compromised. According to Chamberlain (1977), a large portion of the marinas built in the sixties are literally falling apart. Although some of this deterioration may be because of a lack of proper maintenance, most is a result of trying to cut corners in the construction stage. In light of the rising cost of construction materials and labor, there is increasingly a need for rational analysis and design procedures that incorporate the probable environmental loads and material strength properties. The object is to develop an efficient, functional design at reasonable initial cost that will provide an acceptable service life and a minimum of required maintenance. An attractive appearance is generally considered to be of

secondary, but by no means trivial, importance. Chapters 3 and 4 respectively present the design loads and material properties to be incorporated in a successful dock design.

On the surface, the design of docks for small craft harbors seems relatively simple because of their typically uncomplicated structural geometry. Unfortunately, these docks must be located in a coastal environment that is characterized by variable processes and complex loads that are difficult to predict or quantify. Koelbel (1979) states that the design or rehabilitation of a modern marina is a job for an expert, preferably with experience in this particular field. Chamberlain (1977) further suggests that a home-built system is not worth the time and cost. This report is not presented as a structural design handbook, therefore, and is instead intended to provide the designer with the considerations and assumptions particular to marine construction regarding all aspects of small craft dock structures. The design considerations that comprise Chapters 5, 6, and 7 on solid fill, fixed, and floating docks are arranged according to the structural components that make up each system (Figure 1.2).

In addition to the dock structure itself, the modern marina also provides various utilities and special services. While these provisions are not essential, they may make the difference between a marina that is economically viable, and one that operates at a loss. Similarly, dredging operations are necessary to the successful operation of small craft docks both in the initial excavation of the harbor basin, and in maintaining an adequate depth as sediment deposition occurs. These topics are presented in Chapters 8 and 9 respectively.

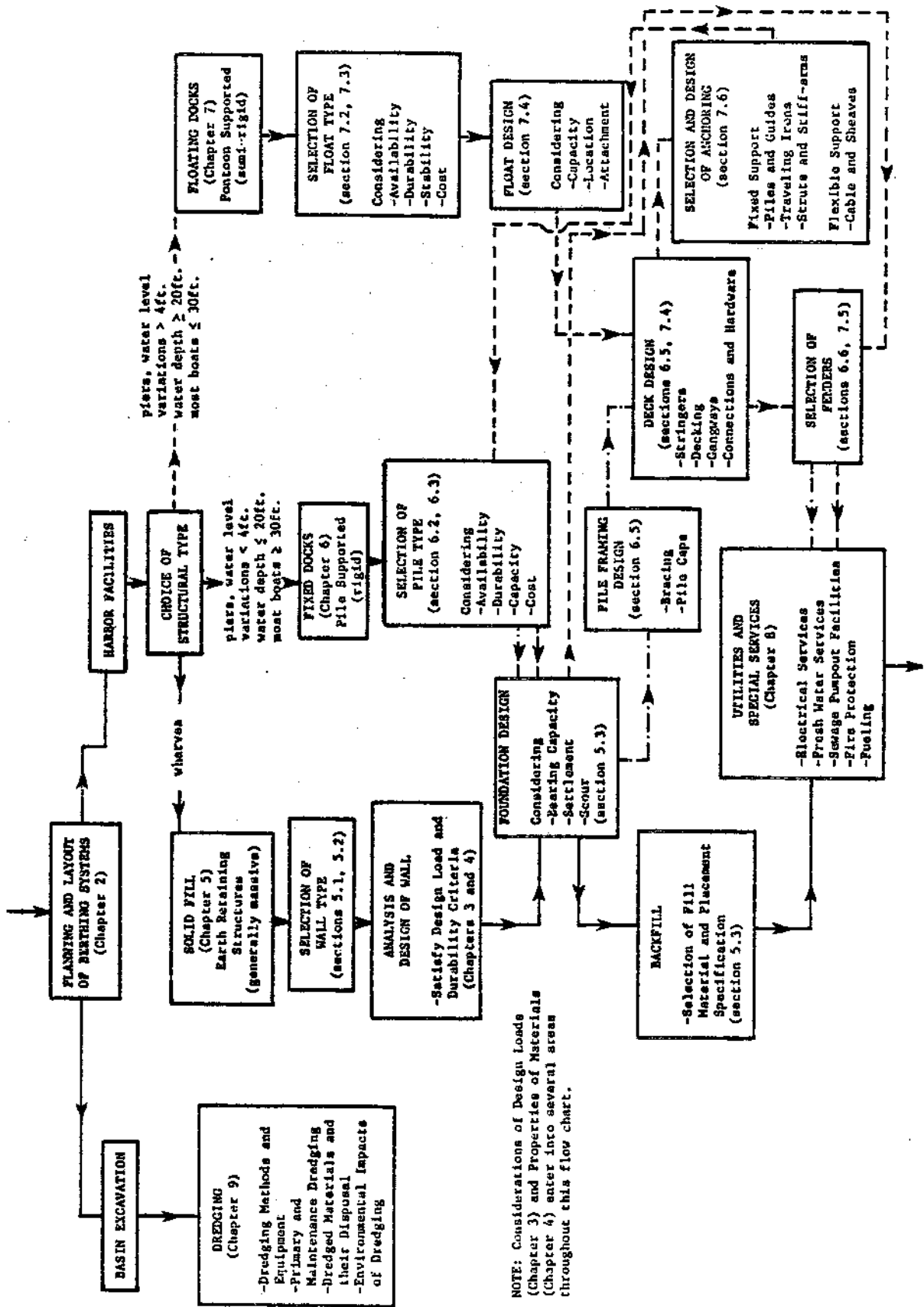

Figure 1.2 Organizational Chart of Design Considerations

While the recommendations of this study are based on the experience of experts as recorded in an extensive body of literature, they must not be considered absolute. The primary reason is that site-specific conditions often impose unusual criteria that must be recognized in dock design. A healthy skepticism should be maintained toward manufacturers of prefabricated systems that claim their product is suitable for virtually all locations.

CHAPTER 2

PLANNING AND LAYOUT OF DOCKS, PIERS, AND WHARVES

The recreational boating industry is currently experiencing a period of continuing growth. Increased demand has led to expansion of existing marina facilities and the construction of new facilities. Proper planning is essential to the functional and financial success of all engineering projects, and marinas are no exception. This section presents the planning and layout considerations that should be addressed in the design of docks, piers, and wharves.

2.1 HARBOR TYPE AND LOCATION

Dock, pier and wharf planning is a direct subset of harbor planning and it would be incorrect to try to separate the two. Numerous site specific design considerations prevent the development of "standard structural types" that are suitable for all locations.

Harbor planning consists of determining the type of harbor to be developed, choosing a location, and integrating all the aspects of inner harbor structures with protective works to make the most of the site. Harbor types are classified by function as harbors of refuge, commercial harbors, and recreational harbors. While this report focuses mainly on recreational marinas, the design considerations presented are equally applicable to commercial and refuge harbors. Commercial installations in general must serve larger vessels (in excess of 50 ft or 15.2 m), while harbors of refuge need to provide a minimum of moorage facilities as an emergency haven protected from storm action (Dearstyne, 1969).

The various locations of small craft harbors include freshwater lakes, river mouths and sides, dredged lowlands and tidal inlets, sheltered bays, and open shorelines. Small lakes generally offer the most mild load conditions with minimal wind and wave action. Marinas located on inland rivers are subject to constant current loads and may require a trailing slip layout or an off-river basin (Figure 2.1). Marina sites near river mouths or in dredged lowlands are subject to both river current and tidal variations. Tidal effects increase as the location approaches the coastline and increased wind and wave loads are encountered. Climatic variations range from cold northern locations subject to severe ice loads, to tropical sites where rapid corrosion is the most serious design criteria.

A comprehensive plan that includes all the components of the inner harbor with provisions for protecting these facilities is fundamental to a smooth running marina. These components typically include berths for permanent mooring, transient berthing, repair stations, fuel docks, boat launch ramps, and in some cases a boat hoisting well. Protective works are commonly provided to mitigate the effects of environmental loads to an acceptable level. The most common protective structures are breakwaters and jetties which reduce wave loads and create a sheltered area in their lee. The analysis, design and construction of these structures is presented by Ehrlich and Kulhawy (1982).

The Ideal Marina Site

In addition to protection from wind and wave loads, Chamberlain (1979) suggests that the ideal marina site would have the following

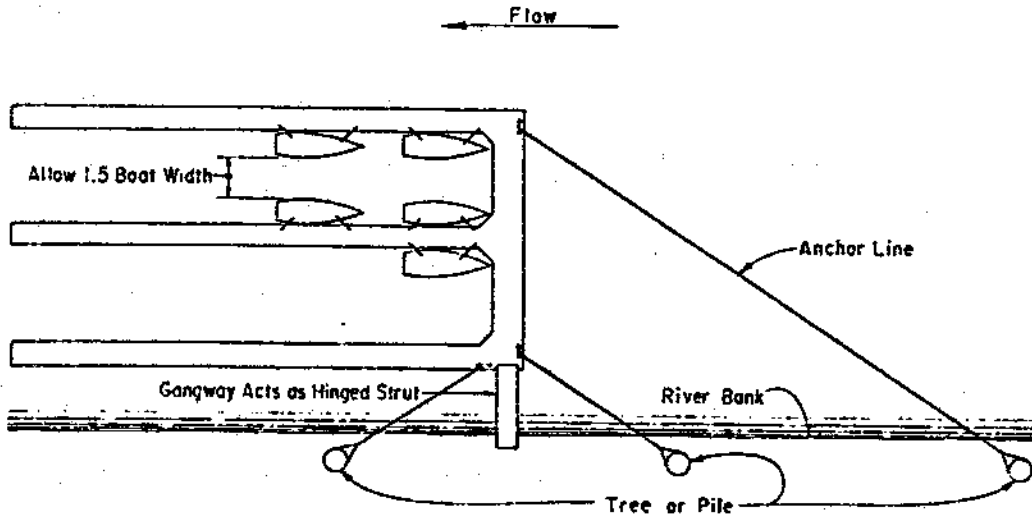

a. Trailing Slips in a River (Dunham and Finn, 1974, p. 21)

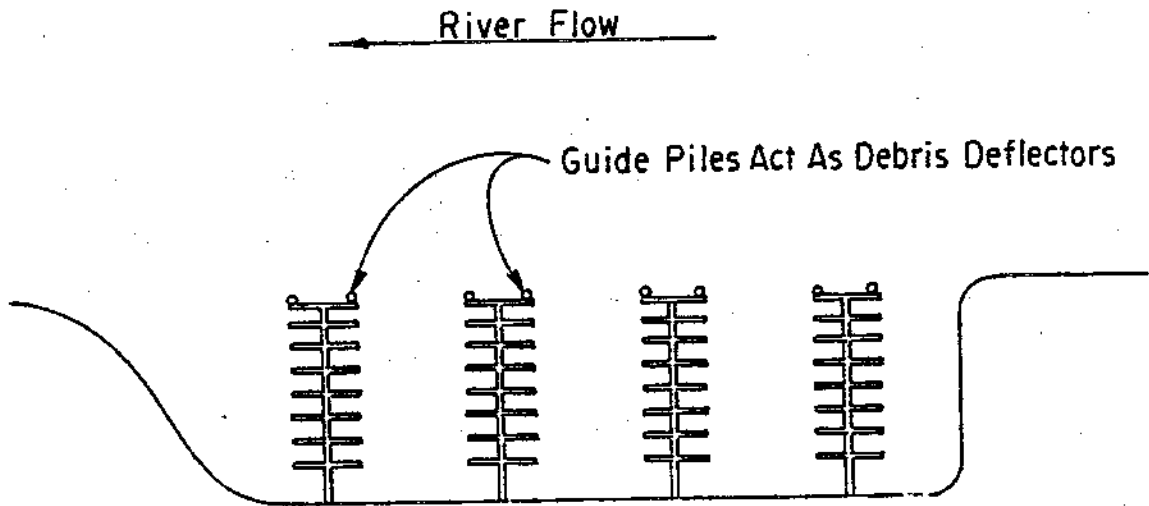

b. Boat Basin Marginal to a River (Dunham and Finn, 1974, p. 73)

Figure 2.1 Inland River Marina Locations

characteristics; a land area of at least 10 acres that is situated well above the flood plain, a useable water area approximately equal to the land area, reasonable proximity to navigable recreation waters as well as at least one major population center, public utilities available at the edge of the property, and water depths of not less than 8 ft (2.4 m) at mean low water (MLW) and no more than 20 ft (6.1 m) at mean high water (MHW).

The design and layout of land space is becoming very critical (Chamberlain, 1977). A land to water ratio of at least one to one is difficult to maintain for many marinas because of the high cost of prime waterfront property. Landside area requirements depend on the harbor type and the facilities to be provided. The shoreside facilities of the typical recreational marina include administrative offices, sanitary conveniences, a marine supply store, a small craft repair area, automobile parking space, and sometimes park and picnic areas. These last items take up the most area and must be planned carefully to achieve smooth traffic flow. Waterside areas are dependent on the number and size of boats to be accommodated, which in turn dictate the arrangement of the berthing facilities. An attempt should always be made to provide room for future expansion as the marina becomes more prosperous. Dock layout for maximum efficiency is addressed later in this chapter.

Water access to a marina is a function of boat speed, the distance to the use area, the "tortuosity" of the channels to be traveled, and the depths of these channels (Dearstyne, 1969). Most planing type power boats can travel at speeds of 15 to 20 mph (24 to 32 kph)

while sailboats can maintain 3 to 5 mph (4.8 to 8.0 kph) depending on the wind velocity and direction. Since the prime purpose of a small craft recreational harbor is to provide moorage within safe, easy, and convenient use of a waterway, long and twisting channels or hazardous obstacles will discourage potential users. Likewise, land travel time should be limited to 1 hr, although the acceptable maximum travel time varies with geographical area (Chamberlain, 1979). The ideal location is one on the outskirts of a city that is near a major highway and in an area compatible with the intended function of the harbor. Heavy industrial or commercial areas should be avoided even if they are easily accessible because of the potential congestion and pollution problems.

Utilities are no longer considered options in dock design but are now essential to a successful marina operation. As such, they must be included in the overall plan for the marina instead of being dealt with as an add-on. It is most convenient if the utility lines from the marina can be connected directly to those of the local municipality. In the case of the sanitary sewer system however, this may not be possible for reasons discussed in Chapter 8.

The maximum and minimum water depths suggested previously for the ideal marina are parameters which partially determine whether it is feasible to construct and operate a marina on that particular site. Other factors include the character of the underlying soil in case dredging is required, the magnitude of the environmental loads, and the history of other structures. If there are no financial constraints, the engineering technology exists to construct docks, piers

or wharves at almost any location. Feasibility, however, requires a balance between technical and financial elements of marina design.

2.2 CHOICE OF STRUCTURAL TYPE

The choice of the type of structure (i.e., solid fill, fixed, or floating) is often a difficult decision that is based on such intangibles as owner preference and esthetics. In general, solid fill docks are best suited to the marginal wharf application where they also stabilize the harbor perimeter. Fixed docks are favored for locations having water level variations of less than 4 ft (1.2 m) and small craft of 30 ft (9.1 m) or more in length (Koelbel, 1979). Water level fluctuations of more than 4 ft (1.2 m) and/or predominantly short (less than 30 ft or 9.1 m) user craft are best served by floating docks. The 4 ft (1.2 m) fluctuation criterion is based on the ease with which boaters can board small craft moored next to a dock. It should not be considered a clear-cut standard since a small, low level boat will be difficult to board from a deck surface as much as 5 ft (1.5 m) above the low water level. The attributes of solid fill, fixed and floating dock systems were noted in Chapter 1 and are discussed further in Chapters 5, 6, and 7 respectively.

2.3 ENVIRONMENTAL IMPACT

The environmental impact of a properly planned marina development is not likely to be particularly severe (Chamberlain, 1979). The most significant impact is a result of dredging operations and the disposal of dredge spoil. The effects of dredging on the environment are largely temporary and include the modification of underwater flow patterns, some turbidity, and the destruction of some underwater habitat. These topics are addressed in detail in Chapter 9. Merely placing a dock

structure in the water of a protected harbor will also have an impact on the environment. In this case the effects are related largely to the interruption of the normal water flow patterns by the structural members or floats. An effort must be made to take advantage of tidal flushing and wind or river currents to renew the water within a marina basin. When such natural processes are not sufficient, flushing currents can be created by pumping water from adjacent water bodies (Figure 2.2).

2.4 LEGAL CONCERNS

The final subject that should be included in dock, pier and wharf planning is that of legal concerns. Specifically, this refers to the agencies on the federal, state, and local level that regulate waterfront construction. There are a number of permits that must be acquired before construction of a marina project can proceed, and these may cause delays measured in years (Chamberlain, 1977).

2.5 LAYOUT AND GEOMETRY OF DOCKS, PIERS, AND WHARVES

The key to a successful berthing system is to use all available area efficiently. The "best" layout is one which provides the most desirable level of service to the greatest number of users in the minimum space for the least cost (Dearstyne, 1969). In practice, however, some compromises are necessary to avoid either crowding or wasted space. Dock geometry involves trade-offs between the dimensions of walkways, slips and fairways while considering such factors as current, wave, and wind magnitude and direction. Appendix A presents selected parts of the berthing layout and design guidelines developed by the State of California (1980). Figure 2.3 illustrates the spatial arrangement of each of the components to be addressed in the following section.

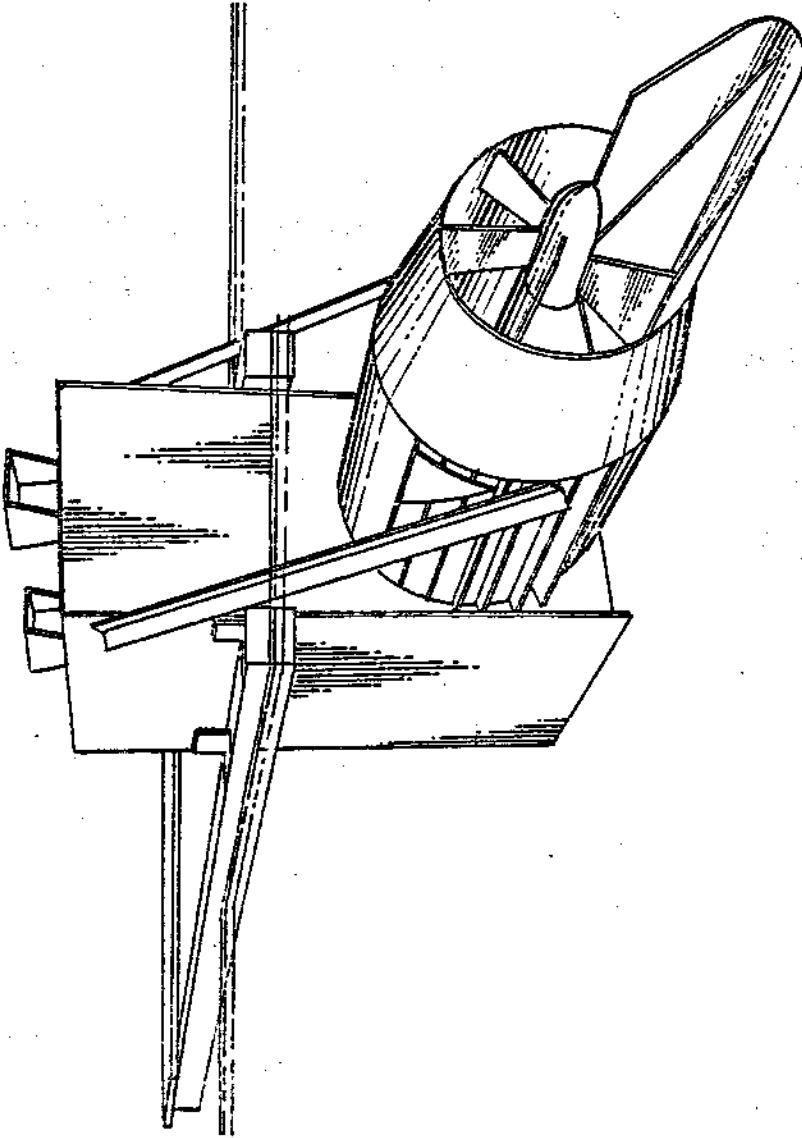

Figure 2.2 Mechanical Current Generator (Dunham and Finn, 1974, p. 40)

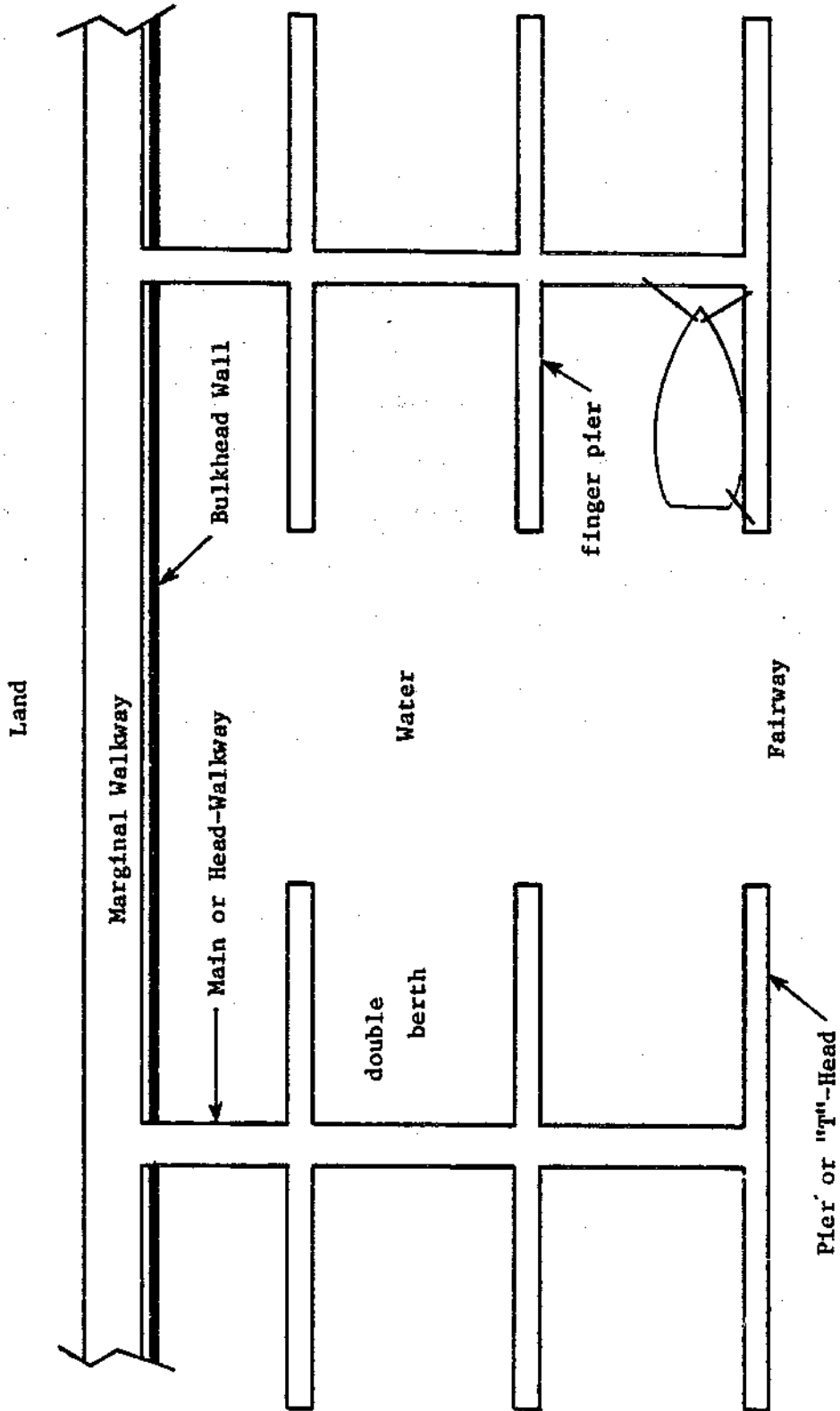

Figure 2.3 Spatial Arrangement of Berthing System Components

Bulkhead and Slip Orientation

Bulkheads are situated along the perimeter of the marina basin, and provide an abrupt land/water interface that allows the area on either side to be used efficiently. On the land side, a marginal walkway is generally located adjacent to the bulkhead (Figure 2.3). Since the depth of water on the harbor side of the bulkhead is sufficient for navigation, boats can be moored right up to the wall. Slips should be oriented parallel to the current whenever possible, but never broadside (Chamberlain, 1979). Where current is negligible, slips are then oriented at right angles to the prevailing direction of approach of short wavelength waves. Because of structural design considerations, slips should always extend at right angles from the main walk, with the main walk oriented perpendicular to the shore line. Along the main walk, slip sizes should be kept constant where possible and, when a mix of slip sizes must be used, the smaller slips should be placed toward the shore (Chamberlain, 1977). Again because of structural design reasons, finger piers should not be staggered along the main walk but instead should always lie in opposition.

Mix of Slip Sizes

A mix of slip sizes must be provided by the marina to accommodate the various boat sizes. Chamberlain (1977) suggests a Gaussian distribution of slip length with a mean of 35 ft (10.7 m). A minimum slip size of 25 ft (7.6 m) should be maintained, while slips longer than 50 ft (15.2 m) are recommended only at the marina owners insistence. Figure 2.4 may be used to determine the percentage of slips that should be installed for a given slip length.

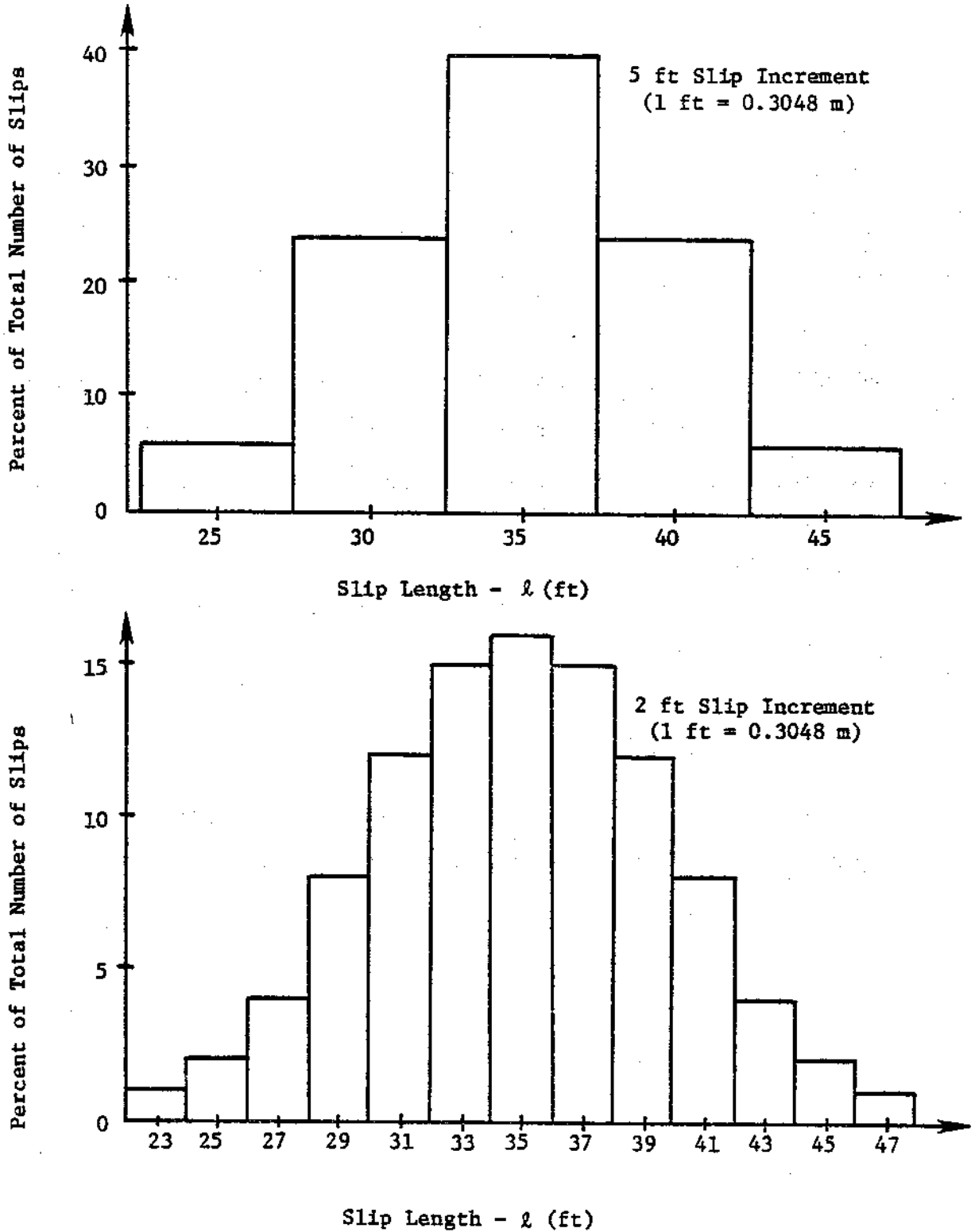

Figure 2.4 Gaussian Distribution of Slip Length
(After Chamberlain, 1977, p. 53)

Slip width is determined by the width of the moored boat plus some clearance for slip entry. Koelbel (1979) recommends that single berths be $1/3$ of the boat length plus 4 ft (1.2 m) while double berths should be two times $1/3$ of the boat length plus 3 ft (0.91 m) as in Figure 2.5. Table 2.1 presents recommended slip widths for fixed and floating single berths based on statistical data (Chamberlain, 1979). Normally, no provision is made for multi-hull boats when laying out small craft berths. Appendix A should be consulted for slip sizes recommended by the State of California (1980), derived from empirical relationships based on field observation and boat manufacturers specifications.

Walkway Sizes

From the shore, a dock user must traverse the marginal walkways, main walkways, and lastly the finger piers. The width of these walkways should be kept to a minimum while maintaining adequate stability (Chamberlain, 1977). Very narrow walkways may be responsible for psychological unease among the marina patrons, regardless of their structural integrity. Koelbel recommends that marginal walkways be 8 ft wide (6 ft or 1.8 m minimum), main walkways 6 ft wide (4 ft or 1.2 m minimum), and finger piers have a width of one tenth their length (2.5 ft or 0.76 m minimum). Appendix A presents the walkway dimensions for floating structures as recommended by the State of California (1980).

Fairway Dimensions

As shown in Figure 2.3, the fairway is the area between the ends of the fingers of adjacent piers. The recommended width of this fairway is 1.5 times the length of the longest slip (Koelbel, 1979; Chamberlain,

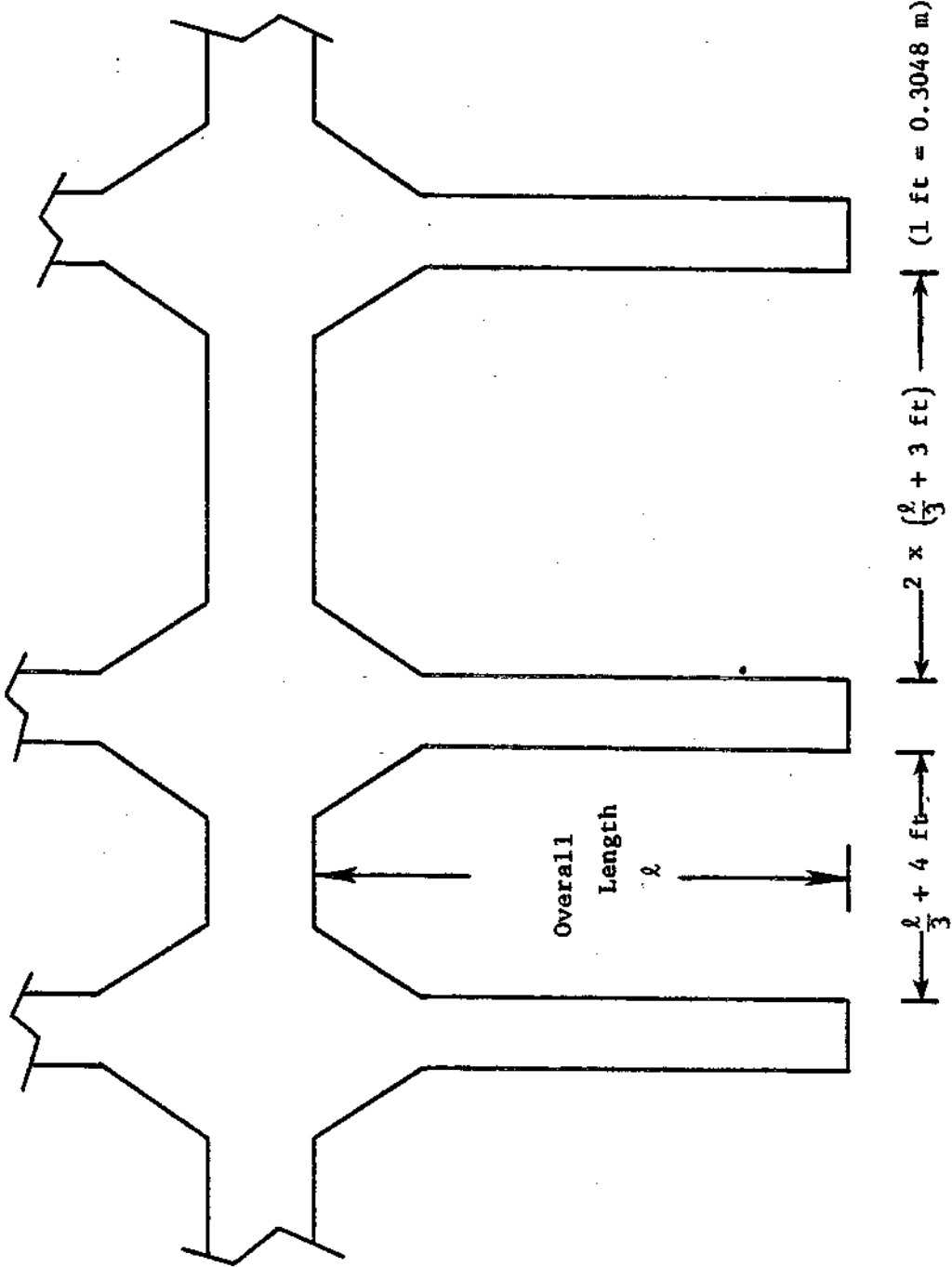

Figure 2.5 Recommended Berth Width for Single and Double Slips (After Koelbel, 1979, p. 5)

Table 2.1 Recommended Slip Widths for Various Slip Lengths
 (Chamberlain, 1979, p. 17)

Slip length	25	30	35	40	45	50	55	60	65+
Width, Floating slips	10	11	12	14	15	17	18	18	19
Width, fixed slips	10.5	11.5	14	15.5	18	19	19	20	22

All dimensions are in feet
 (1 ft = 0.3048 m)

1979). If the berthing area permits increasing this width, a fairway of 2 times the longest slip length is suggested for current velocities of 2 to 3 knots (3.7 to 5.6 kph) parallel to the longest dimension of the slip. The extra room makes maneuvering into the slip much easier. Fairways should in no case be less than 1.25 times the longest slip length.

Internal Harbor Channels and Turning Basins

The entrance to a harbor basin must be narrow enough to protect the basin from external wave energy while being wide enough for safe maneuvering. Chamberlain (1979) recommends that the entrance be 4 times the beam of the widest boat in the marina or no less than 60 ft (18.3 m). Once inside the entrance, the interior channel should expand to a clear width of twice the entrance width if possible; otherwise 100 ft (30.4 m) is a suggested design standard. The entrance and channel should be oriented so that boats can easily pass through in case of storm conditions, fire, or other emergency. Where practical, the entrance should be aligned broadside to the prevailing wind for ease of passage by small sailboats without auxiliary power.

Turning areas are a necessary part of a marina layout, particularly in the vicinity of fueling or sewage pumpout facilities. A turning area of 2.25 times the length of the longest boat should be adequate for most boat types and average pilot skill according to Chamberlain (1979). This area should be increased to 2.5 or 2.75 times the longest boat for user craft that are predominantly single screw power boats or if frequent on-shore winds are anticipated.

2.6 SUMMARY

The planning and layout of small craft harbors and dock facilities is very important to their functional and financial success.

Recreational marinas are located in many different sites ranging from sheltered inland lakes to exposed coastlines. The severity of the environmental loads imposed, and the degree of protection required, increase with the increased exposure of an open shoreline.

Protective structures in the form of breakwaters and jetties are installed in exposed locations to create a calm berthing area. The design of these structures must be incorporated in the overall planning stage to avoid resonance because of trapped wave energy.

In addition to a calm berthing area, the "ideal" marina should have a land to water area ratio of one to one, ease of access by land and water, reasonable proximity to a center of population as well as recreational boating waters, access to public utilities, and a basin geometry in which dock design is technically and financially feasible. Dock structures for small craft harbors generally consist of a solid fill wharf around the perimeter leading to a fixed or floating pier depending on the magnitude of water level variations.

An efficient dock design and layout is essential to the success of a recreational marina. In general, a good layout should maximize the number of boats berthed per acre without causing navigational or safety problems. Layout refers to the spatial arrangement of bulkheads, slips, walkways, fairways, and internal harbor waterways. The dimensions of these components should be minimized while maintaining structural integrity and stability of the docks and navigability of the waterways.

An exception to this rule occurs for locations subject to more severe wave, wind, or current loads that could cause maneuvering problems.

CHAPTER 3

SUMMARY OF DESIGN LOADS

Sound engineering design of any structure must include a discussion of design loads. In the case of docks, piers, and wharves, the major environmental design loads are waves, wind, current, and ice. Loading conditions that may be considered man-made include boat impact, and dead and live loads. While it is not usually practical to design for catastrophic loads, it is important to discuss them, as well as precautionary measures that may help avoid damage.

It is also important to compute accurately the magnitude of each load category as the cost of the finished structure is directly proportional to the severity of the design loads. Loads should be calculated on the basis that all berths are occupied by the largest vessel that can be accommodated since wind, wave, and current forces are generally assumed to act on the boat hulls and have negligible effect on the structure alone. Hubbell and Kulhawy (1979b) discuss general environmental loads acting on coastal structures. The following section presents methods for estimating the loads to be used in design.

3.1 DESIGN WAVE AND WAVE FORCES

A harbor by definition should provide a place of refuge for boats with a protected entrance to allow for safe access. There exists some maximum acceptable wave height within a harbor under which a boat may be handled safely without undue hazard to either the boat underway or the surrounding harbor structures. Depending on the characteristics of the using craft, the normal criteria for acceptable maximum wave

height are 2 to 4 ft (0.61 to 1.22 m) in the entrance channel, and 1 to 1.5 ft (0.30 to 0.46 m) in the berthing area (Dunham and Finn, 1974). Since floating docks derive their support from the water surface, they are obviously much more susceptible to wave action than are fixed docks. A wave height of about 2 ft (0.61 m) is the maximum allowable for any floating system for structural design reasons. This value is generally used as a design wave for small craft harbors, and protective structures must be provided to shelter inner harbor facilities in locations subject to greater wave energy.

Wave energy within a harbor may have three sources, including wave energy generated within the harbor by boats, wave energy generated within the harbor by wind, and external wave energy passing through the harbor entrance.

Boat-generated wave energy (wake) is a function of boat displacement, speed, and distance from the sailing line. As displacement and distance are not practical variables in minimizing boat wake, it is common to post a five mile per hour (8 kph) speed limit on the busier waterways. Speed limits must be strictly enforced if the harbor structures are expected to reach their design lives without major maintenance. Boat wake generation is discussed by Seymour (1977) and Das (1969).

Wave energy generated within the harbor is usually negligible for small craft marinas. Local wind waves may become appreciable, however, if long unrestricted overwater fetches within the berthing area are aligned with the prevailing winds, or under hurricane conditions. The result will be short period, steep sided waves that cause excessive agitation in the berthing area. These local wind waves may present

a severe wave loading condition since their short periods may correspond to the natural period of oscillation of berthed small boats. Hubbell and Kulhawy (1979b) review techniques for predicting waves. If it is found that local wind waves may be a problem, alteration of the harbor geometry or construction of an inner-harbor protective structure is required.

External wave energy may only enter the harbor by way of an uninterrupted waterway or by overtopping the harbor boundaries. In the process of harbor planning, breakwaters and jetties are commonly provided to furnish protection for the harbor area, and create a safe, convenient navigable entrance. To obtain an acceptable wave environment with minimal harbor surge, the planner must design the entrance (using variable geometry and orientation) such that the external wave energy is properly attenuated. Obviously this process can only be started with a study of the wave input: wave height, period and direction. Next a refraction and diffraction diagram analysis should be performed to determine the optimum orientation of the protective structures (See Hubbell and Kulhawy, 1979b). Finally, model studies may be useful to check the actual performance of the layout and make adjustments if necessary to obtain maximum attenuation.

In a discussion of wave forces on docks and piers, a distinction must be made between breaking and non-breaking waves. Breaking waves create a state of dynamic loading in which air pressures and impact must be considered. Non-breaking wave forces are not as abrupt and are usually applied to the structure as a static load. According to Hubbell and Kulhawy (1979b), wave breaking is likely to occur for basin depths less than 1.5 times the incident wave height. The suggested 2 ft (0.61 m) design wave will not break in the berthing area of a marina since

the depth required for navigation is greater than 3 ft (0.9 m). Therefore, the assumption will be made that all wave forces are caused by non-breaking 2 ft (0.61 m) waves, and these loads will be applied as static loads. It should be noted, however, that waves are a cyclic phenomena and that fatigue of the structural connections may be a problem.

Dock structures are usually analyzed for wave loading applied in the principal directions, parallel and perpendicular to the axis of the main walkway. If the structure has adequate strength in these directions, it has been found that all other orientations will be satisfactory as well (Dunham and Finn, 1974).

Horizontal wave forces on a floating body may be determined using the Froude-Kriloff theory as described by Brater, McNowen, and Stair (1958). This procedure is presented graphically in Figure 3.1 and is based on the assumption that the berthed craft can be approximated by a barge-like hull shape that is in contact with the pier (Winzler and Kelly, 1979). Given the characteristics of the berthed vessels and the approaching wave, the wave force (F_{wl}) on a floating object is taken from Figure 3.1 in terms of the object's displaced volume. Figure 3.2 may be used to estimate the displacement volume (V_d) of small craft as a function of their overall length. Figure 3.3 is then consulted to adjust the final wave force for the length of the floating body relative to the wave length. A sample calculation of wave force is demonstrated in Design Example 3.1

In the case of floating docks, two additional wave load situations must be considered. First, when the incident wave is travelling parallel to the structure face, bouyancy will not be uniform along the length

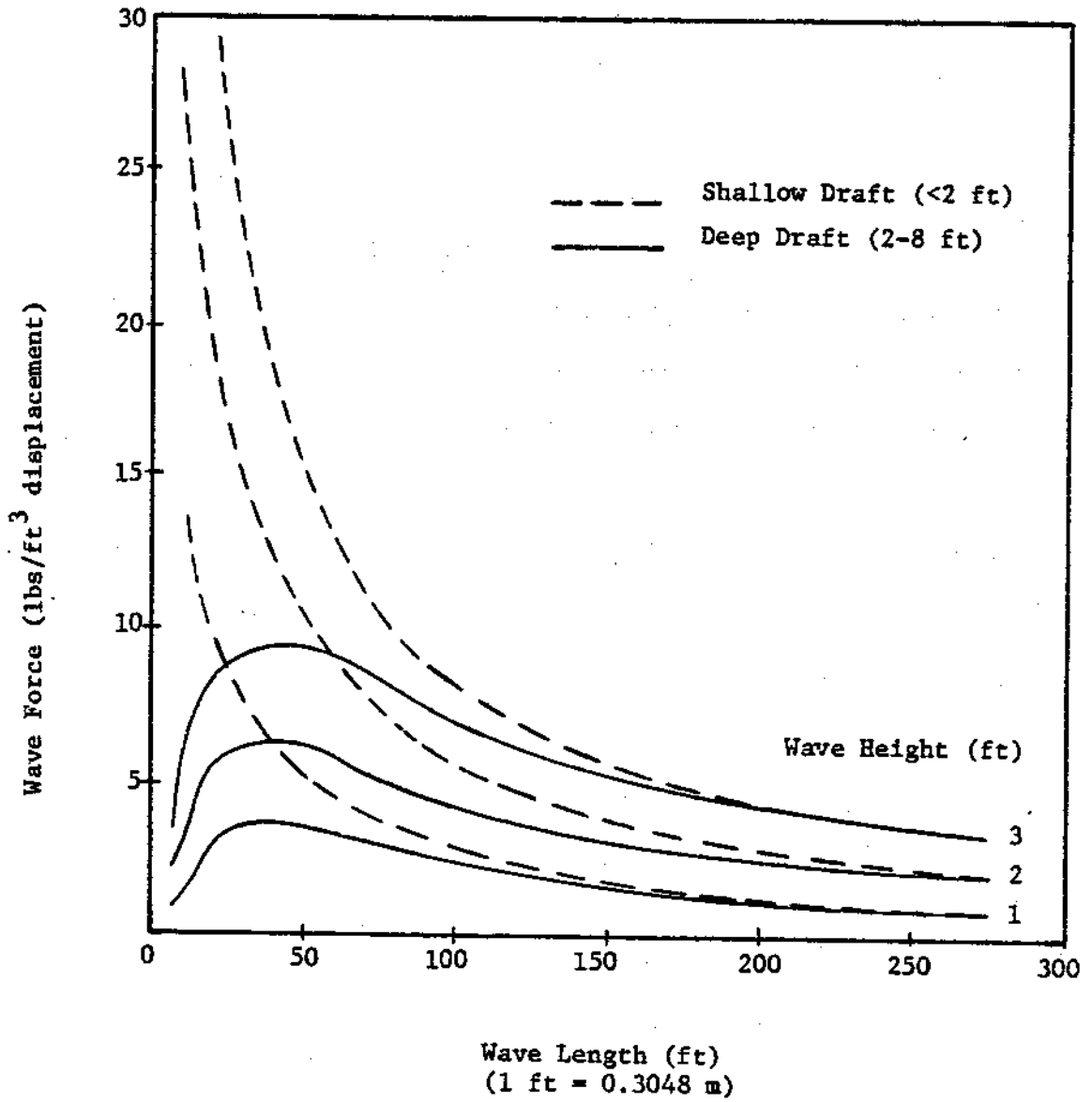

Figure 3.1 Horizontal Wave Force on a Floating Object (Winzler and Kelly, 1979, p. III-16, after Brater, McNown and Stair, 1958)

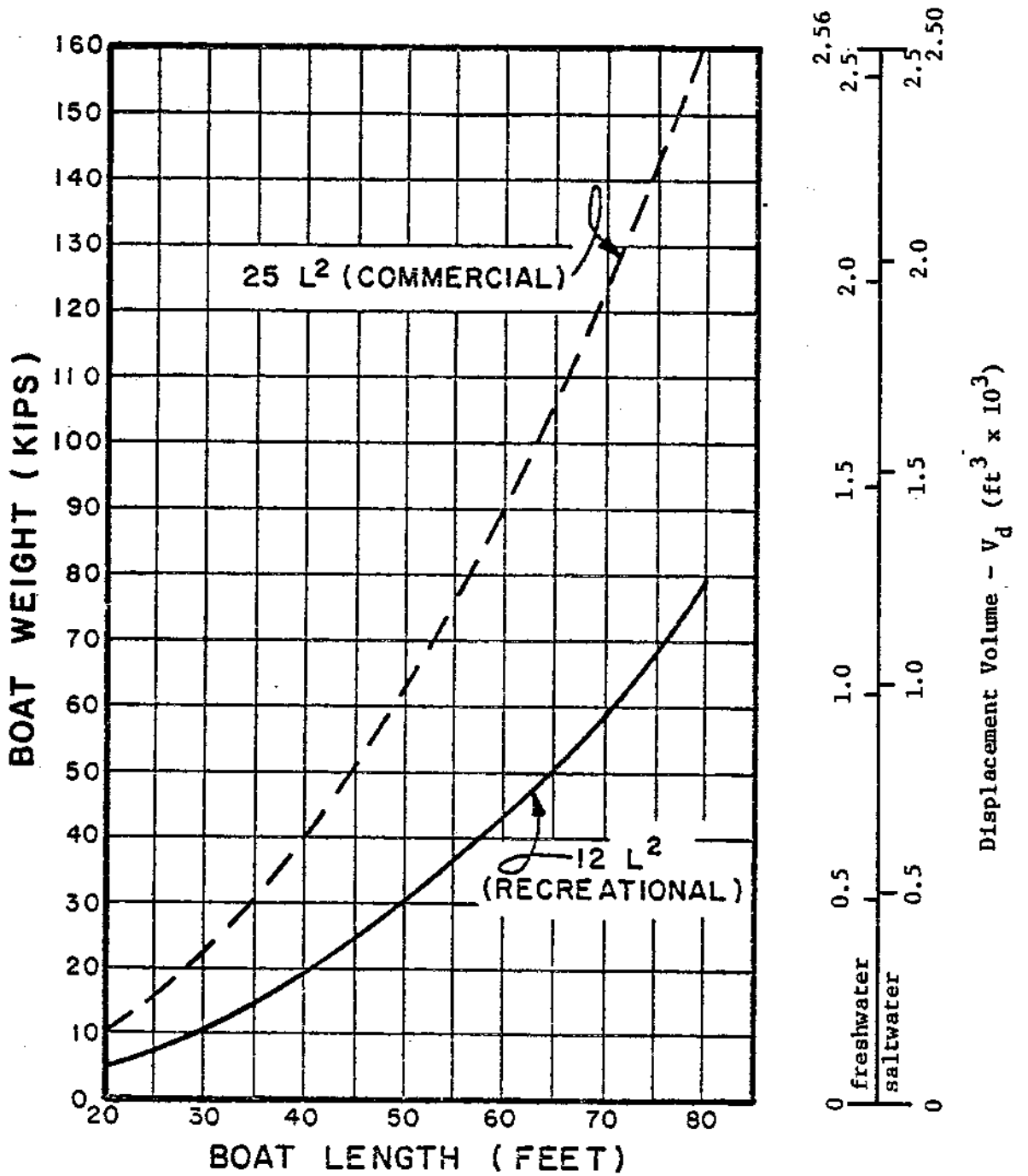

Figure 3.2 Small Craft Weight and Displacement Volume
 (State of California, 1980, p. 16)

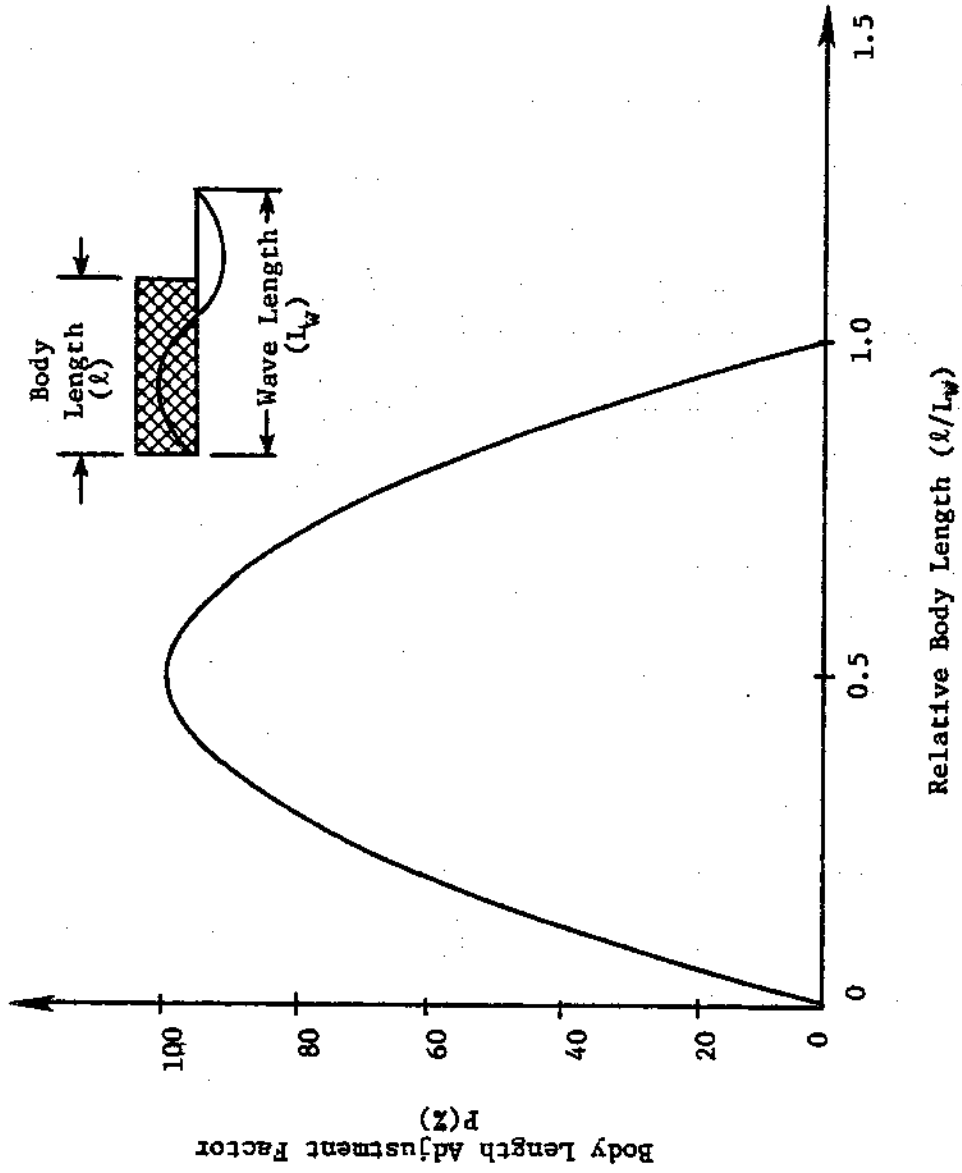

Figure 3.3 Wave Force Adjustment for Relative Body Length
(Winzler and Kelly, 1979, p. III-17)

Design Example 3.1Given:

A deep draft recreational vessel with an overall length of 30 ft, width of 7.5 ft, berthed in a saltwater mooring, and moored broadside to the direction of wave attack.

Find:

Wave force (F_{wl}) to be resisted by each finger pier because of a wave of 20 ft length and 2 ft height.

$$\text{Figure 3.1} \quad F_{wl} = 5.8 \frac{\text{lbs}}{\text{ft}^3} \text{ displacement}$$

$$\text{Figure 3.2} \quad V_d = 157.4 \text{ ft}^3$$

$$\text{Figure 3.3} \quad \lambda/L_w = \frac{7.5}{20} = 0.375$$

$$\text{Body adjustment factor } P = 0.92$$

Therefore:

Wave force on each finger pier

$$F_{wl} = 5.8 \frac{\text{lbs}}{\text{ft}^3} \times 157.4 \text{ ft}^3 \times 0.92$$

$$F_{wl} = 839.88 \text{ lbs}$$

$$= 0.84 \text{ kip}$$

of the float system. The system should be analyzed for the location of the incident wave where it produces maximum moment and shear forces. Second, horizontal wave forces on the dock profile are usually considered negligible where deep draft craft (2 to 8 ft : 0.61 to 2.44 m) are moored at the berth. When shallow draft craft (less than 2 ft or 0.61 m) are moored at the berth, however, the wave force on the face of the dock should be estimated. The dock width is not to be added to the craft width to obtain the body length used in Figure 3.3 since the connection is not rigid. The displacement volume (V_d) of the dock may be found using the dead and live load weights described later in this chapter and Figure 3.3 of this section.

Attempts have been made to refine the wave force analysis to recognize the fact that most boats are moored in such a way that the hull is not in contact with the dock (See Section 6.6). Unfortunately, the analysis becomes complex as the vessel is able to translate relative to the dock. This movement is restrained by the mooring lines, but the load must still be considered dynamic. For example, Raichlin (1968) developed an analytical model in which the restoring forces of quasi-elastic mooring lines respond in a nonlinear fashion to boat displacement as a result of wave impulse loads. The restoring force predicted with this method correlated well with measured values for a series of field tests.

3.2 WIND LOADS

The maximum lateral load on a harbor structure is most often the result of wind pressure. Strong, steady winds usually cause loads greater than those produced by waves, current, or impact. The wind velocity,

shape of the exposed object, and the severity of gusts are factors influencing the design wind load which is usually expressed as a pressure acting on the above-water profile.

In many areas, the design wind velocity may be taken from local building codes. Where these specifications are not available, local wind records, or isotachs such as that shown in Figure 3.4 should be used.

In the case of the local wind records, it is important to ascertain how and where the measurements were made. The wind velocity variation with elevation is generally assumed to be logarithmic with near-surface winds being much less severe than those measured at the standard altitude of 30 ft (9.1 m). Figure 3.5 is a dimensionless plot of altitude Z versus mean wind velocity \bar{V}_w , and may be used to reduce wind velocity measured at standard elevation to a design wind velocity at the level of the overwater profile. Figure 3.6 is presented to permit reduction of wind velocity not measured at standard height. The relationship used to develop this profile is taken from Linsley, Kohler, and Paulhus (1975) and is expressed as follows:

$$\frac{\bar{V}_w}{\bar{V}_{w1}} = \frac{\ln\left(\frac{Z}{z_0} + 1\right)}{\ln\left(\frac{Z_1}{z_0} + 1\right)} \quad (3.1)$$

in which: \bar{V}_w = unknown mean velocity at profile height Z

\bar{V}_{w1} = measured mean velocity at altitude Z_1 (usually 30 ft or 9.1 m)

and z_0 = roughness length (Table 3.1)

The roughness length (z_0) of Equation 3.1 is defined as the height above the surface at which the wind velocity is zero. Values of roughness length are presented in Table 3.1 for various terrains including a rough

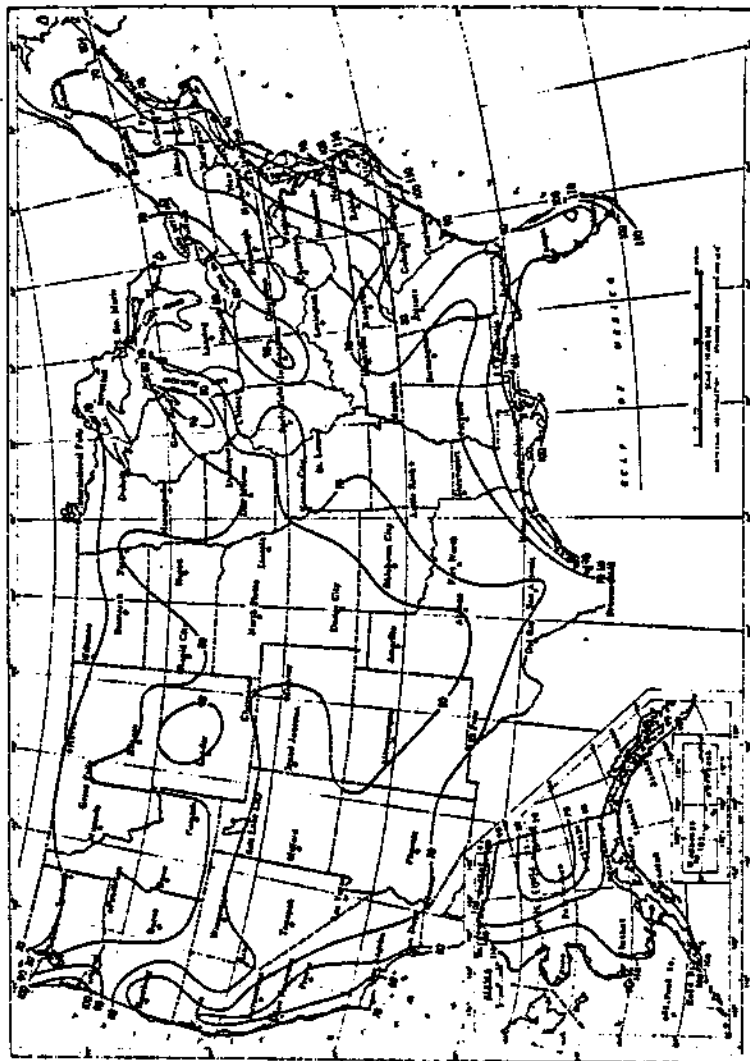

Figure 3.4 Isotach of Maximum Wind Velocity (mph), 30 ft (9.1 m) above ground, 50 year recurrence period (Dunham and Finn, 1974, p. 134) (1 mph = 1.61 kph)

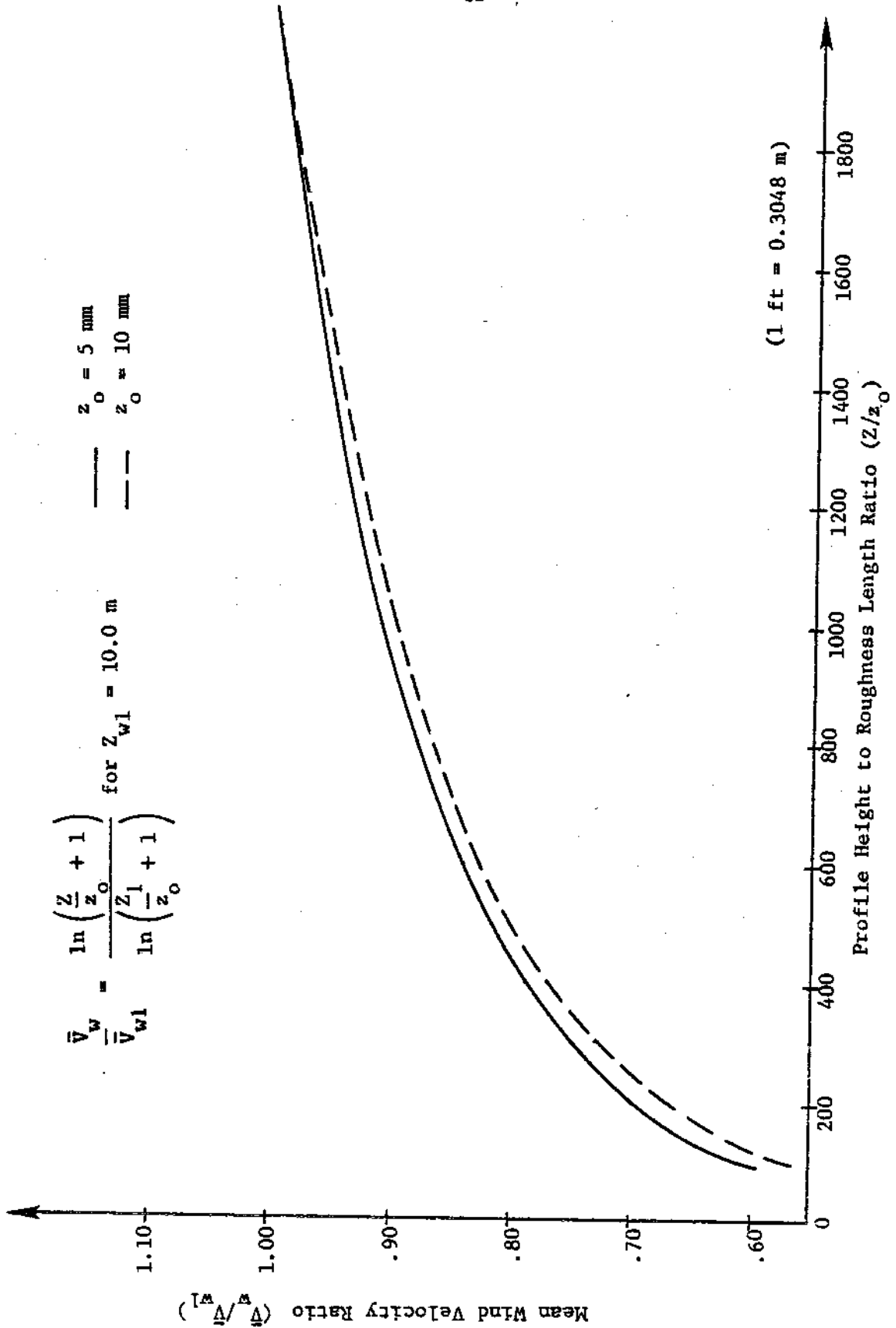
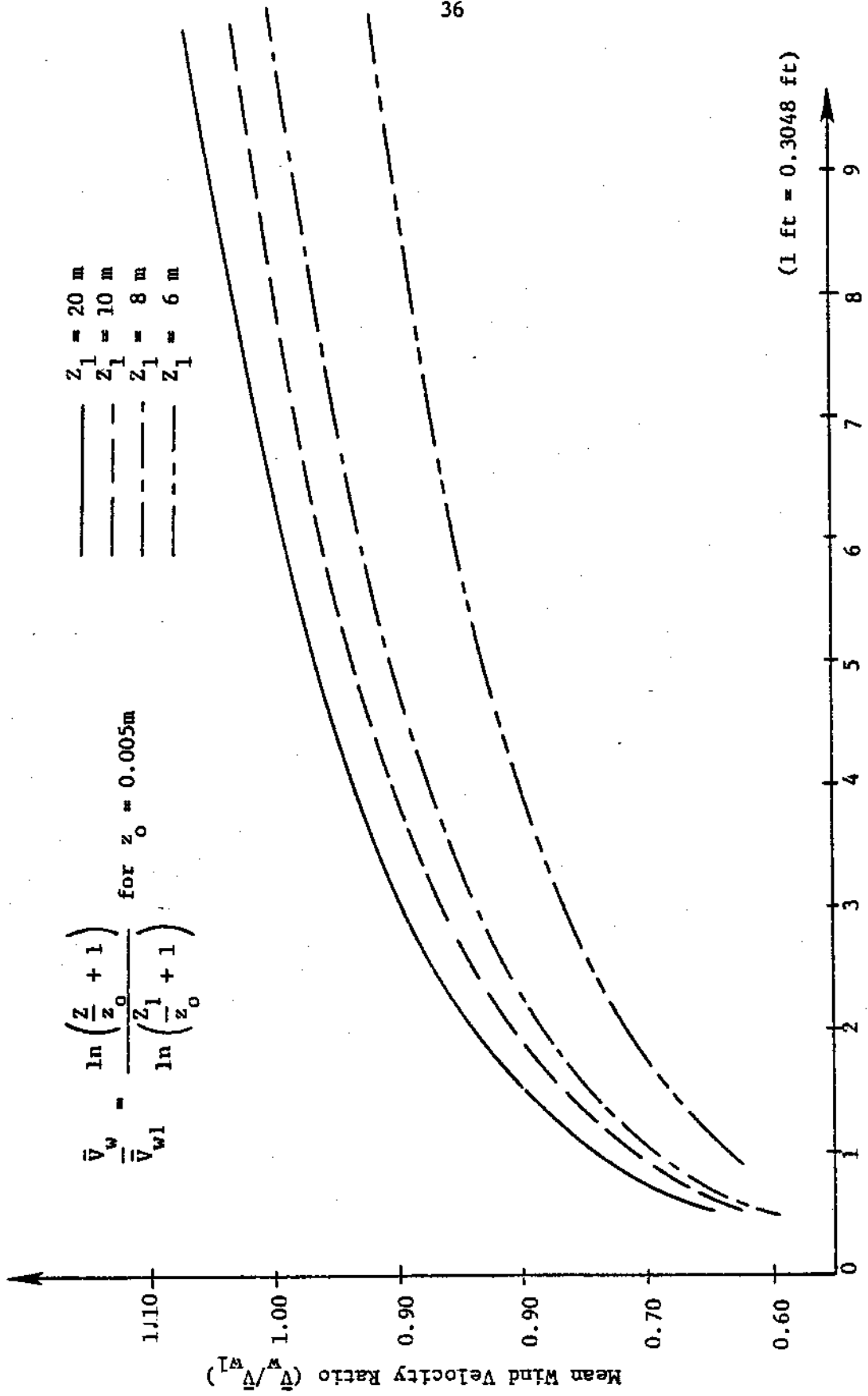

Figure 3.5 Mean Wind Velocity versus Altitude (After Linsley, Kohler and Paulhus, 1975, p. 43)



Profile Height - Z (m)

Figure 3.6 Mean Wind Velocity versus Profile Height (After Linsley, Kohler and Paulhus, 1975, p. 43)

(1 ft = 0.3048 ft)

Table 3.1 Typical Values for Gradient Height, Surface Drag Coefficient and Roughness Length (Davenport, 1980, p. 237)

Terrain	Gradient Height z_g		Surface Drag Coefficient		Roughness Length z_o	
	ft	(m)	K	in.	in.	(mm)
Rough Sea	825	250	0.001	0.2 to 0.4	0.4	5 to 10
Open Farmland	975	300	0.005	0.4 to 5.0	5.0	10 to 100
Forest and Suburban Areas	1300	400	0.015	12.0 to 40.0	40.0	300 to 1000
City Centers	1650	500	0.050	40.0 to 200.0	200.0	1000 to 5000

sea. The use of the minimum suggested roughness length (0.2 in. or 5 mm) is a conservative assumption that would, to some degree, compensate for gust loads. Wind gusts are usually assumed to have negligible effect because of their short duration, the high inertia of the boats, and the flexibility of the mooring system.

After the mean wind velocity has been determined, it must be resolved into a force acting on the structure. Hubbell and Kulhawy (1979b) present the following expression relating mean wind velocity to the wind pressure (P_w) that acts on the above-water profile of a dock system:

$$P_w = 0.004 \bar{V}_w^2 \quad (3.2)$$

in which: \bar{V}_w = mean wind velocity (mph)

P_w = wind pressure because of \bar{V}_w (psf)

This relationship is presented graphically in Figure 3.7. The wind pressure from Equation 3.2 or Figure 3.7 must be multiplied by the appropriate above-water profile area to determine the actual wind load. Figure 3.8 presents the profile height (h) of small craft as a function of their overall length (l). A sample calculation of wind force (F_{w2}) may then be performed as in Design Example 3.2. Note that in Design Example 3.2, the profile of the small craft is taken as its overall length times its height, resulting in a flat-sided, barge-like shape. For most modern recreational boats, this assumption is quite conservative.

During the structural analysis phase of dock design, wind loads must be applied to individual fingers as well as to the entire system. Wind loads over the length of a dock can be greatly reduced because of a shielding effect of the boats to the windward side. Winzler and Kelly

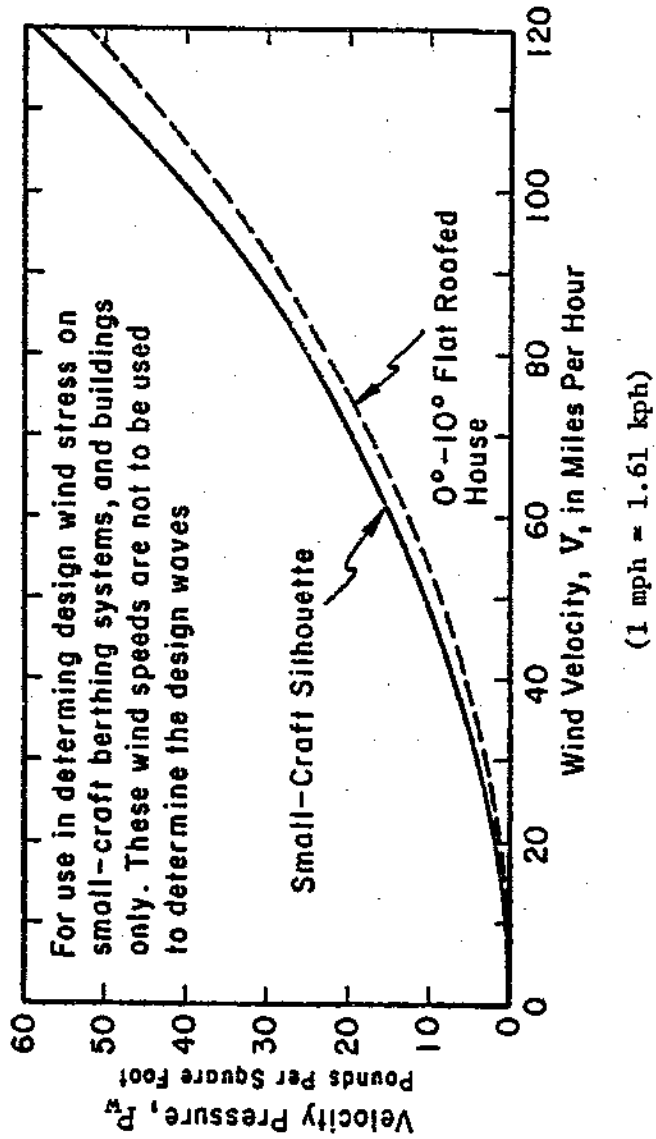

Figure 3.7 Horizontal Wind Pressure on a Vertical Face
(Dunham and Finn, 1974, p. 134)

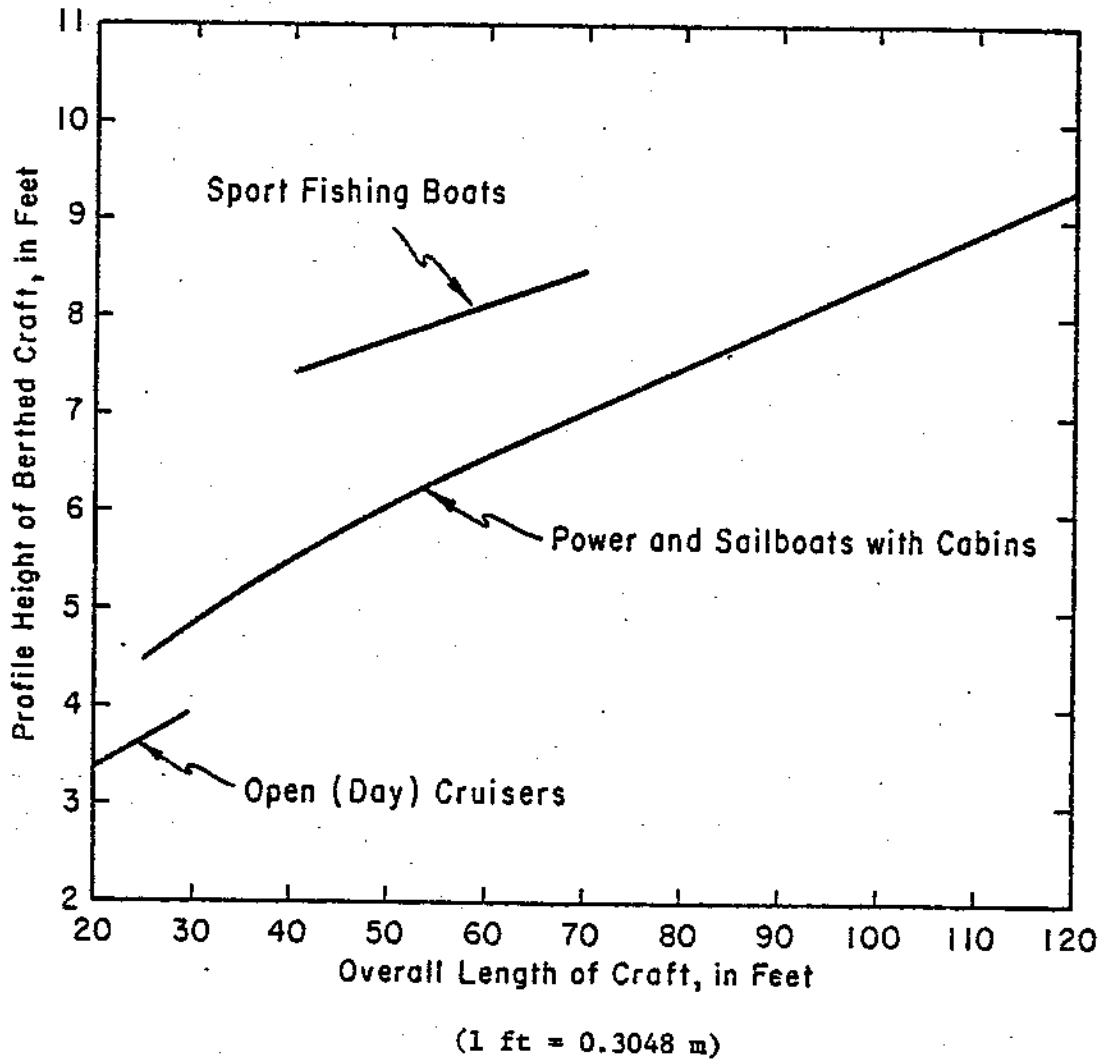

Figure 3.8 Above Water Profile Height versus Length of Craft (Dunham and Finn, 1974, p. 135)

Design Example 3.2Given:

A single power boat 30 ft long, moored broadside to the direction of wind movement.

Find:

The wind force (F_{w2}) to be resisted by each finger pier because of a wind with an average velocity (\bar{V}_w) of 60 mph.

Figure 3.7 Wind Pressure $P_w = 14.5$ psf

Figure 3.8 Profile height $h = 4.9$ ft

$$F_{w2} = 14.5 \text{ psf} \times 4.9 \text{ ft} \times 30 \text{ ft}$$

$$F_{w2} = 2131.5 \text{ lb}$$

$$= 2.1 \text{ kip}$$

(1979) recommend a design value of 15 percent of the full wind pressure be applied to boats that are shielded by other boats, or structures, while Dunham and Finn (1974) suggest 20 percent.

3.3 CURRENT LOADS

The primary sources of water currents include river flow, tidal variations, and harbor surge. River currents vary little in magnitude (peaking at the flood stage of the river) and are constant in direction. Tides on the other hand produce a sinusoidal load that reverses direction in a predictable manner. Where river flow and tides interact along a coast line, currents may be much stronger in one direction controlled by the constant flow of the river. Harbor surge occurs primarily because of surf beat resonance.

When a resonant wave system is set up within a harbor, currents are produced at the nodal points of the waves. At this location, the vertical motion is negligible, but the horizontal motion of the water particles may be quite strong. Figure 3.9 illustrates the superposition of waves because of resonance and the resultant harmonic motion. A good discussion of resonance is presented by Galvin (1969). Nodal current velocity may be from 2 to 4 fps (0.6 to 1.2 m/s) while currents from tidal action are typically an order of magnitude less and may be considered negligible. Because of the large variation of current speeds within the berthing area, no standard minimum pressure has been adopted and current load design is performed on the basis of the maximum expected current. Current load from harbor surge must therefore be used uniformly unless it can be proven that resonance will not occur.

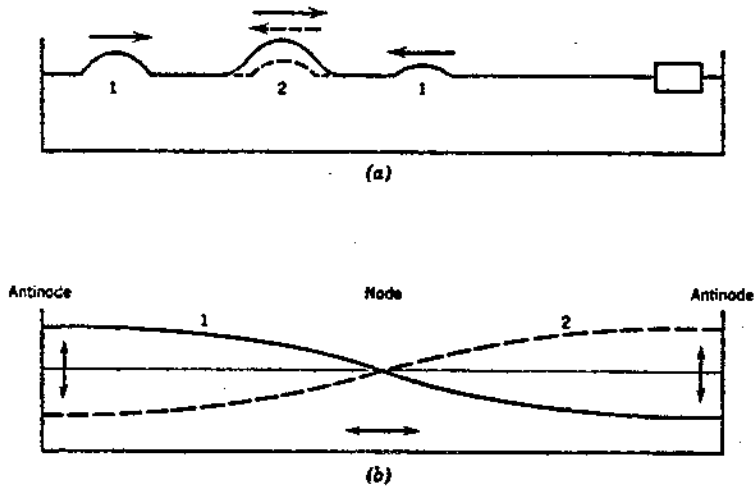

(a) SUPERPOSITION OF WAVES; (b) GEOMETRY OF NODE AND ANTINODE

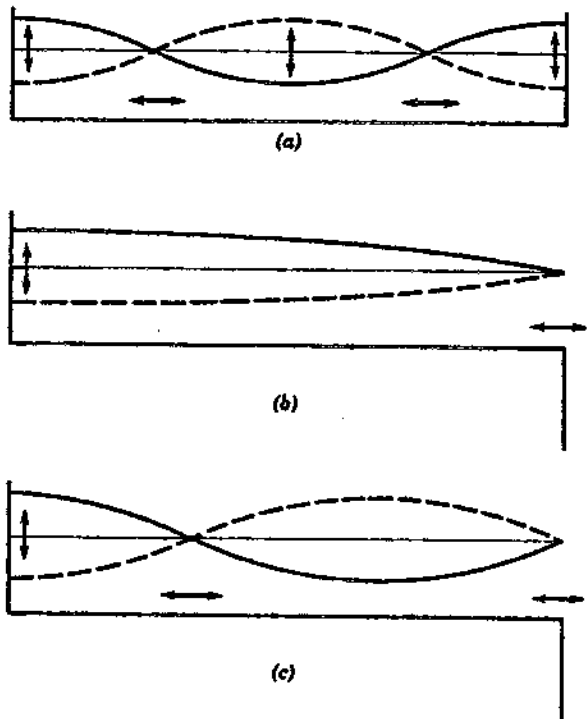

DISTRIBUTION OF NODES AND ANTINODES: (a) SECOND HARMONIC FOR CLOSED HARBOR; (b) FUNDAMENTAL FOR OPEN HARBOR; (c) SECOND HARMONIC FOR OPEN HARBOR

Figure 3.9 Superposition of Waves and Harmonic Motion (Galvin, 1969, pp. 78 and 81)

Current force, F_c , is related to current velocity through the following expression:

$$F_c = P_c \times A_{c2} = \frac{\gamma_w \times V_c^2}{2g} \times A_{c2} \quad (3.3)$$

in which: P_c = current pressure (psf or kN/m^2)
 γ_w = unit weight of water (pcf or kN/m^3)
 = 62.4 pcf (9.8 kN/m^3) fresh water
 = 64.0 pcf (10.1 kN/m^3) salt water
 V_c = current velocity
 g = constant of gravitational acceleration
 = 32.2 ft/sec^2 (9.81 m/sec^2)
 and A_{c2} = underwater profile area

Figure 3.10 relates current pressure to current velocity for both salt and fresh water using Equation 3.3. Since there is only a 3 percent difference between these curves, the salt water curve may be used when the composition of the water is uncertain without being over-conservative. Figure 3.11 shows underwater boat profile height versus boat length and should be used to compute the underwater profile area, A_c . As in the case of wind loading, underwater profile height is often assumed to be 15 percent of slip length (Winzler and Kelly, 1979). Figure 3.11 shows, however, that this approximation is only accurate for commercial fishing boats and may be in error by ± 2 ft (0.61 m) depth for a 40 ft (12.2 m) boat.

The application of current loads to a berthing facility is performed in the same manner as wind loading. Winzler and Kelly (1979) again recommend applying 15 percent of the maximum current load to shielded

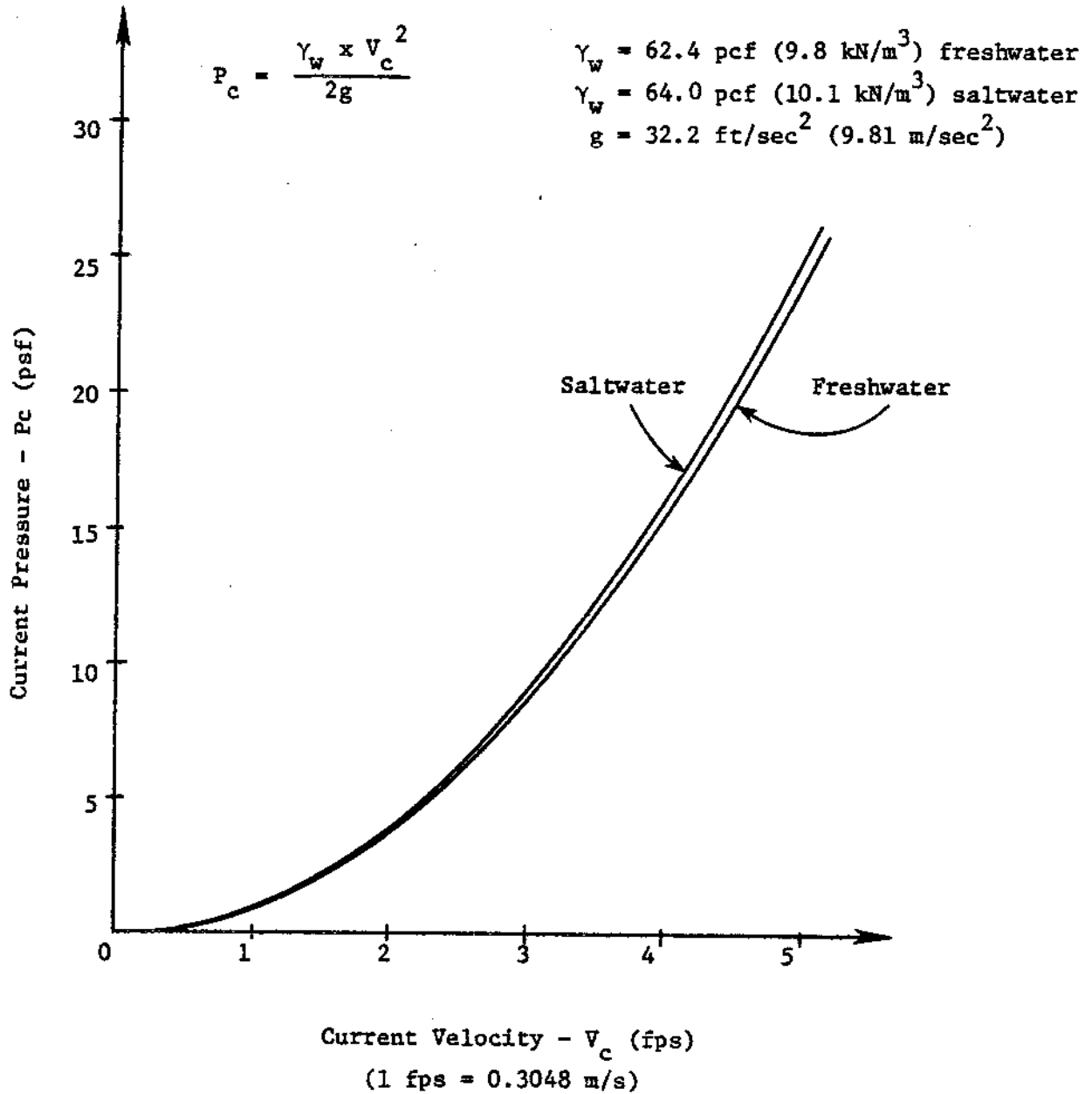

Figure 3.10 Current Pressure versus Current Velocity
(After Quinn, 1972, p. 296)

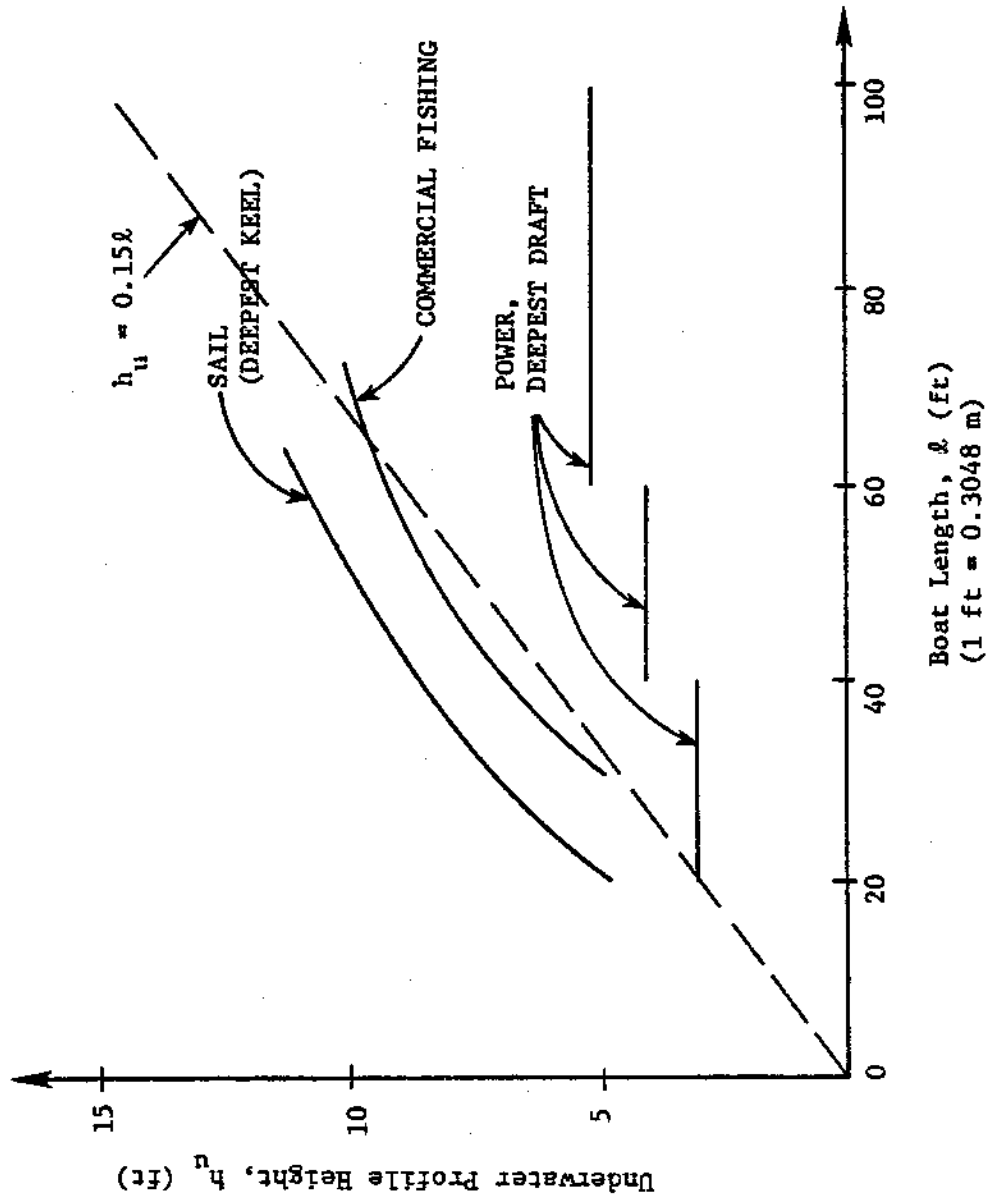

Figure 3.11 Underwater Profile Height versus Boat Length
 (Winzler and Kelly, 1979, p. III-11)

hulls. Cheung and Kulhawy (1981) may be consulted for current forces on piles.

3.4 BOAT IMPACT

Impact loads occur as two objects collide. Minor collisions are a common event in small craft harbors as boats are maneuvered into their berths. Since direct contact of the boat and dock may result in damage to both, some form of protection or "fendering" is commonly provided to absorb the energy of impact:

Impact may be seen as a form of kinetic energy:

$$\text{Impact} = \text{K.E. (Kinetic Energy)} = \frac{1}{2} \frac{W_{\min} V_B^2}{g} \quad (3.4)$$

where: g = constant of gravitational acceleration

$$= 32.2 \text{ ft/sec}^2 \quad (9.81 \text{ m/sec}^2)$$

V_B = velocity of boat normal to the dock

W_{\min} = weight of boat

$$= 12 L^2 \text{ for pleasure boats}$$

$$= 25 L^2 \text{ for commercial boats}$$

and L = length of boat

This relationship is presented in a convenient graphical form in Figure 3.12. Figure 3.2 depicts boat weight as a function of length.

The variables of boat impact as shown above are boat weight and velocity. Weight may not be considered a true variable since it depends on the geometry of the slip which must be designed to withstand the impact of the largest boat it can accommodate. Note that the weight curves of Figure 3.2 are minimum values and should be adjusted upward by the designer to account for special passenger or cargo loads.

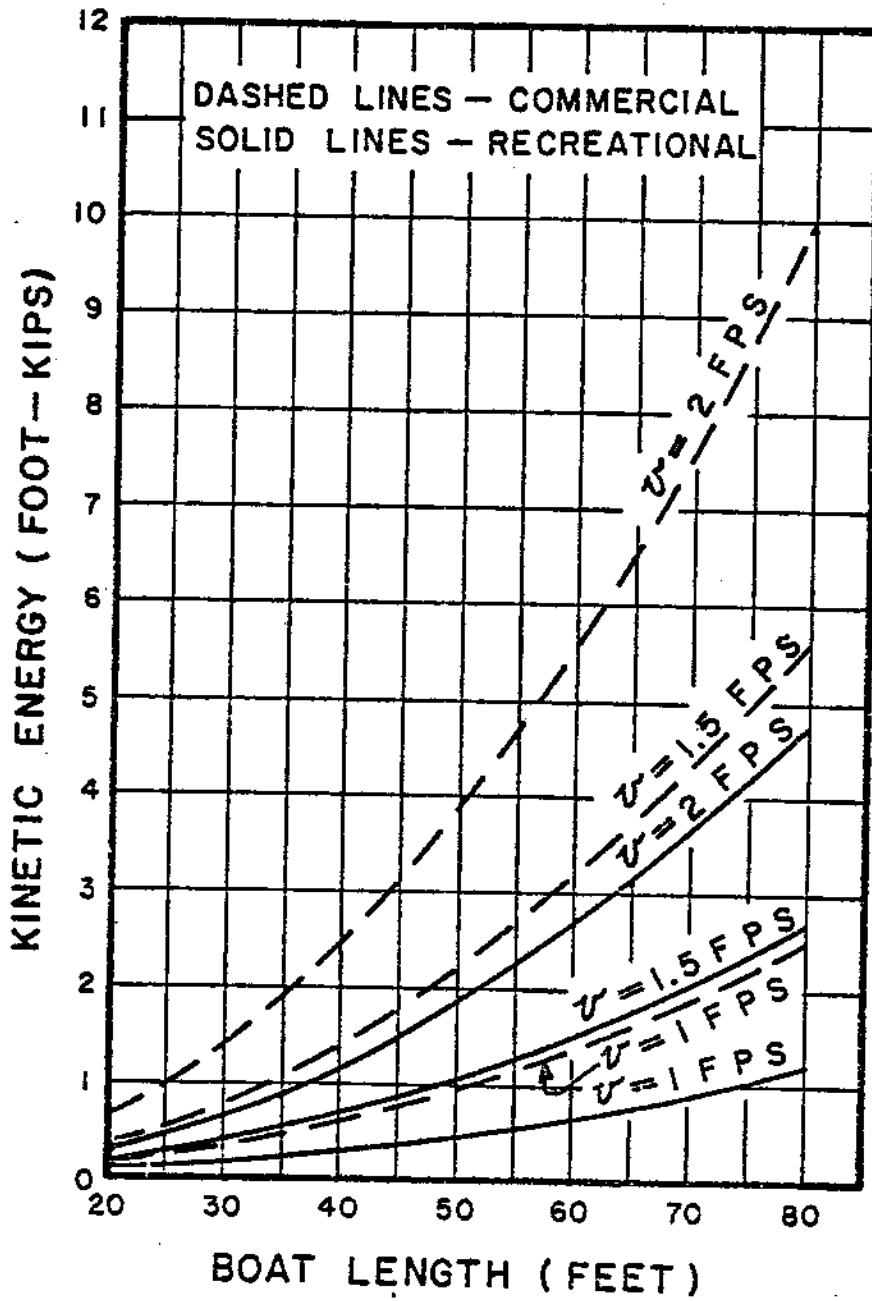

Figure 3.12 Docking Impact Energy for Small Craft
(State of California, 1980, p. 6)

Impact velocity depends not only on pilot skill but also meteorological and oceanographic conditions (Cheung and Kulhawy, 1981). As the speed of approach must be assumed, herein lies the greatest uncertainty. The impact velocity is a critical parameter since impact energy varies with the square of the velocity. Winzler and Kelly (1979) recommend that a velocity of one foot per second (0.3 m/s) normal to the dock be assumed for small boats. This is also a minimum value and should be increased subject to the designers discretion, if difficult docking conditions are anticipated.

Figure 3.13 illustrates a boat entering a slip and impacting one of its sides. In adverse conditions, the boat may not enter the slip perfectly and will, therefore, contact the slip at some small angle. Quinn (1972) suggests an approach angle of 10 degrees with respect to the face of the dock to be used for design purposes. Note that a velocity of 1 fps (0.3 m/s) normal to the dock corresponds to an approach velocity of $3\frac{1}{2}$ knots (1.0 m/s) for an angle of 10 degrees.

The energy to be absorbed by the dock and fender system is usually taken to be half of the kinetic energy as obtained in Figure 3.12. Figure 3.13 shows that the point of contact is assumed to be at the one fourth point along the boat, and that the impact energy acts through the center of gravity of the boat. As a result, the center of gravity tends to rotate about the point of contact, causing a hydrostatic pressure build-up along the side of the boat that absorbs some of the energy of impact. Figure 3.14 relates the percentage of impact energy (K_D) that must be absorbed by the fender system, to the berthing contact

- c.g. - Center of Gravity
- V_A - Approach Velocity
- V_B - Velocity of Boat Normal to Dock
- E - Impact Energy
- L - Overall Boat Length

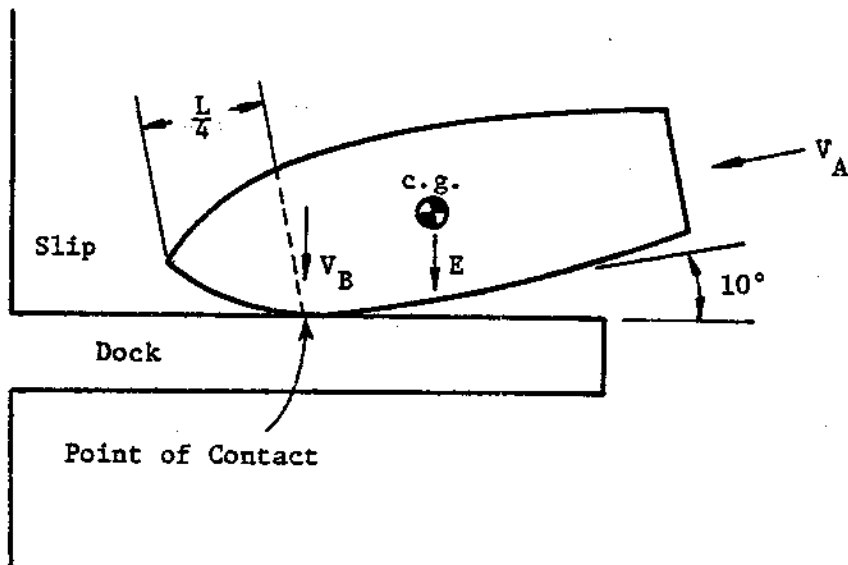

Figure 3.13 Assumed Geometry for Boat Impact Analysis
(After Quinn, 1972, p. 384)

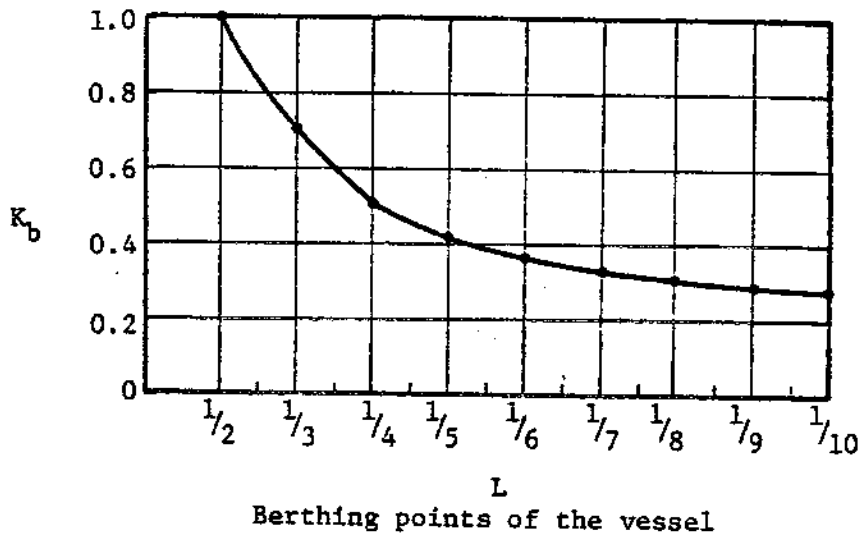

Figure 3.14 Impact Energy Reduction Factor versus Berthing Point (Quinn, 1972, p. 385)

point along the boat ($K_b = 0.5$ for contact of $L/4$). Note that if the boat strikes at its midpoint all of the impact energy must be acting on the dock directly. This maximum value ($K_b = 1.0$) should be used for small boats when adverse conditions such as high winds or turbulent water are expected since the orientation of approach will be uncertain. The reduction in impact energy should be made, however, for larger boats and calm weather conditions.

Impact loading is the primary design criterion of fendering systems. Fenders act to distribute impacts into the major structural components of the dock without causing large stress concentrations. Since impact tends to be of short duration, it should not be combined with large wind or current forces. Impact energy has the dimensional units of work (ft-lbs) and must be absorbed through a displacement of the fender. Impact is obviously a case of dynamic loading, but analysis of a structural system for such a load is very complex. It is common practice to apply impact as a static load so that the relationship between impact energy and fender deformation becomes:

$$\text{K.E.} \times K_b = k\Delta^2 \quad (3.5)$$

where:

K_b = reduction coefficient for berthing point
(see Figure 3.14)

k = stiffness of dock and fender system (k/ft)

Δ = deformation of the fender under impact (ft)

The stiffness (k) of a fender is defined as the force caused by a unit displacement, and is a function of the material properties of the fender, and the structural design of the supporting framework. The necessary

stiffness is determined by the maximum deformation that can be tolerated.

3.5 ICE LOADS

Northern harbors present a very hostile environment for harbor structures. Ice forces are responsible for extensive damage to boats, docks and piers. While it is possible to avoid damage to most boats by removing them from the water, large floating docks, fixed docks, and piers must be designed to resist ice loads. The ice forces themselves may be minimized by reducing the ice sheet thickness with compressed air bubbler systems. The design details and limitations of these bubbler systems are discussed by Ashton (1974).

Significant vertical and horizontal loads result from the formation of ice in a harbor. Vertical loads are caused by ice "grip" as ice adheres to the surface of floats, piles and bracing. Fluctuation of the water level then imposes load from the water-ice system on to the structure. Sieche action (responsible for most winter water level fluctuation) is the short term rise and fall of water level caused by persistent strong winds piling up water, or because of changes in barometric pressure over the lake (Wortley, 1979). The period of a sieche may range from a few minutes for a bay or harbor to ten hours for a very large lake, and water level changes of 3 in. (76 mm) in ten minutes are common. Uplift forces are caused by bouyancy of the ice as the water level seeks to rise. Downdrag results when the water level lowers and the ice sheet becomes an added "dead load" as it hangs up on the structural members.

Lateral ice loads may be broken down into two categories, including

thermal expansion loads and ice floe impact loads. Expansion of ice as it freezes generates tremendous compressive forces if the ice is confined. In some cases horizontal pressures of 400 psi (2.7 MN/m^2) (the approximate crushing strength of ice) have been used for pier design, as reported by Wortley (1979) but this may be overly conservative. In practice, ice crushing strength is less because of impurities and cracking. Ice floe impact is caused by the momentum of moving ice blocks and is often ignored as a design criterion. Wortley (1979) observed that the horizontal forces of the moving pieces generally do not exceed the mooring forces for which the docks are designed, so no special analysis is required.

The engineering characteristics of ice and the different forms of ice loading are discussed further by Hubbell and Kulhawy (1979b). Procedures are presented to estimate the magnitude of ice loads. Note that the flexibility of the dock system, and the rate of deformation have considerable influence on ice forces. These variables are often site specific and must be recognized by the designer when applying ice loading to the trial design. Another important parameter, ice thickness, is dependent on location, severity of the winter, and the salinity of the water. Salt water typically freezes at 28°F (-2°C) while fresh water freezes at 32°F (0°C). An ice sheet in salt water will always be thinner than in fresh water for the same temperature conditions, thus reducing the ice load. Where salinity is uncertain, it is conservative to assume fresh water.

3.6 DEAD AND LIVE LOADS

A dead load by definition includes the combined weights of all the components that are considered permanent in a structural system. For a fixed pier, the dead load will be the sum of the weights of all

piling, pile caps, stringers, decking, fenders, hardware, and any permanently attached accessories. In the case of a floating dock, the piling, pile caps, and stringers are replaced by flotation units, wales, and gangways. Permanent accessories include pipes, pumps, utilities, fire fighting equipment, storage lockers, etc. The dead load in its various combinations must be added to the live load to develop a design load for each structural component.

The unit weight of the timber used in construction should be assumed to be a minimum of 35 pcf (5.5 kN/m^3). Dry Douglas fir or Southern pine for example may have a dry unit weight of 35-40 pcf ($5.5 - 6.3 \text{ kN/m}^3$), disregarding the retention weight of water or preservatives. Actual density in service will depend on the species of tree, moisture content, and the type of preservative treatment. Hubbell and Kulhawy (1979a) may be consulted on wood properties and preservatives. Reinforced concrete using standard aggregate has a unit weight of 150 pcf (23.6 kN/m^3). The unit weight of steel is 490 pcf (77.2 kN/m^3) but weight per lineal foot is usually specified by the manufacturer for common structural shapes. Aluminum has a unit weight of approximately 169 pcf (26.6 kN/m^3), but this may vary considerably depending on the type of alloy. As in the case of steel, manufacturers supply the weight per lineal foot of aluminum members.

Live load criteria are usually specified by local building codes. In the absence of such specifications, there are accepted minimum loads that should be applied to the various types of structures.

Fixed piers are normally designed for a deck live load of not less than 100 psf (4.8 kN/m^2) of deck area on main walkways. Finger piers having limited access are often designed for 50 psf (Dunham and Finn,

1974). This design live load must be adjusted by the designer if vehicular traffic or heavy cargo is anticipated. Piers upon which a vehicle may be driven should be designed for at least H 10-44 loading as specified by the AASHTO Standard Specifications for Highway Bridges (State of California, 1980). H 10-44 loading specifies a 20,000 lb (89 kN) truck having a 14 ft (4.3 m) wheelbase and a front/rear axle weight distribution of 4,000 lb (17.8 kN) and 16,000 lb (71.2 kN) respectively.

Floating docks must be provided with sufficient flotation to support their dead load plus a uniform live load of 20 psf (1.0 kN/m^2). A floating pier used solely for pedestrian access to a floating structure, however, should be designed to support its dead load plus a minimum live load of 40 psf (1.9 kN/m^2) since there will be heavy traffic. An exception may be made in the case of a rough water installation using a thin-deck laminated wood float system (State of California, 1980). Under these conditions, it is advantageous to maintain a "flexible" structure, and the use of the 20 psf (1.0 kN/m^2) live load requirement results in a large number of flotation pontoons that act to "stiffen" the system. Under no circumstances should a live load less than 12 psf (0.6 kN/m^2) be used for any floating dock.

Both fixed and floating structures must also be able to support a 400 lb (1.8 kN) concentrated load without overstressing the framing members or creating more than a 6° tilt of the deck surface. This concentrated load need not be applied simultaneously with the uniform live load previously discussed.

The State of California (1980) recommends that gangways up to 6 ft (1.8 m) in width be designed to support a minimum live load of 40 psf (1.9 kN/m^2) while those greater than 6 ft (1.8 m) wide must support

at least 100 psf (4.8 kN/m^2). Note that half of the live load on the gangway must be transmitted to the end of a floating pier. Extra flotation must be provided to support this concentrated load.

A final live load specification refers to walkway and gangway railings. The railings should be capable of withstanding a horizontal force of 20 ppf (0.29 kN/m) at their highest point from the deck (State of California, 1980).

3.7 CATASTROPHIC LOADS

Catastrophic loads are caused by meteorological events such as earthquakes, hurricanes, and tsunamis. As stated in the introduction, it is not practical to design docks, piers, and wharves to resist these severe loads directly. Protection in the form of breakwaters or jetties should be provided during the harbor planning and layout phase so that the harbor performs as an integrated system.

In areas where the probability of catastrophic loading is high, heavy emphasis should be placed on early warning and emergency evacuation systems. If the marina operator is given sufficient warning of the approach of a storm it may be possible to secure the harbor and avoid major damage. Some preparations that may be made include: the transfer of small boats from the water to dry storage to minimize wind and current loads, inspection of moorings to make sure that all lines are snug and in good condition, checking the placement of portable fenders, disconnection of electric and fuel lines in case of rupture, and clearing all personnel from the area.

Tsunamis are long period (10-20 minute), high velocity (several hundred miles per hour) waves of seismic origin (Dunham and Finn, 1974).

As these waves approach shore, they cause water level fluctuations like a rapid tide with a magnitude of several feet. Some design considerations for tsunami prone areas are as follows: anchorages must resist the lateral loads of tsunami-generated currents, anchor pile tops in a floating slip system must be high enough that the floats do not rise above them, pile guides should be provided with a barnacle shearing device to keep floats from hanging up on anchor piles as the trough passes, and the basin area should be dredged deep enough so that the berthed craft are not lowered to the bottom.

3.8 COMBINATION OF LOADS

It is clear that harbor structures must be designed to resist individually each of the load categories previously mentioned. While it is not likely that these loads would act on the structure simultaneously, it is important to consider possible combinations. Most of the loads are caused by the environment and typically fluctuate in both magnitude and direction with time. Current, wind, and wave forces may in some cases be directly additive, but it would not be reasonable to combine them all indiscriminantly at their maximum values. Two cases of combined loading will be considered for this report. Case 1 will apply wind pressure directed perpendicular to the structural element with waves of a suitable length to maximize lateral load also approaching perpendicular to the element. This combination produces the maximum horizontal load that can normally be expected. Case 2 maintains the wind pressure normal to the dock element, but applies a variable length wave moving parallel to the structure. The result is a combination of vertical and horizontal loads that may be critical for wale design and connections.

Current forces have not been included in the above combinations because the loads produced by harbor surge are very severe and harbor surge is a relatively rare occurrence that can be avoided through proper layout and planning. This is not to say that such current loads will not or do not occur. Winzler and Kelly (1979) suggest that to accommodate such site specific conditions, designs should assess environmental loading conditions that may require more stringent loads, or which may require reductions in allowable stress because of fatigue considerations. To be thorough, the analysis should be sufficiently detailed to apply to specific locations within the berthing area where increased loads may be experienced.

3.9 SUMMARY

The several types of loads that should be addressed in the design of harbor structures such as docks, piers, and wharves have been introduced herein. Procedures are presented to determine the forces because of wind, wave, current, boat impact, ice, and dead and live loads. Catastrophic loads caused by earthquakes, hurricanes, and tsunamis are also discussed briefly but it is not usually practical to incorporate them in structural design.

Most of these loads are a product of environmental conditions and are highly variable in magnitude and direction over time. The loads used in design must be appropriate to the location of the structure, taking into consideration site specific conditions. Underestimation of the design loads will usually result in premature failure while being overconservative causes costs to become excessive. Good judgment in the estimation of design loads is the first step toward obtaining proper performance at an acceptable price.

CHAPTER 4
ENGINEERING PROPERTIES OF MATERIALS

Material properties are an important aspect in the process of structural design. From the designer's point of view, each material should be used "efficiently" in an effort to make the most of its structural capabilities while at the same time minimizing first cost. The owner on the other hand will be more concerned with maintenance costs and service life. Therefore, the material must be functionally adequate as well as structurally sound. An untreated timber pile that comes under the attack of marine borers may quickly lose its strength and fail prematurely. In this case, the material is initially strong enough to support the loads, but it is unacceptable because of environmental factors. The marine environment is usually very hostile toward engineering works, and a useful service life may be difficult to achieve unless the proper material is chosen. For a discussion of the deterioration process and the corresponding protective measures available, the reader should refer to Hubbell and Kulhawy (1979a). This chapter will focus on the engineering properties of the materials and how they influence performance in a coastal structure. Concrete, steel, and wood are the principal materials addressed since they are the ones most commonly used. Emphasis has been placed on concrete and wood since they may be quite variable as structural materials and are often misused. Other materials including aluminum and wrought-iron are also mentioned briefly.

4.1 CONCRETE

As with other structural materials, strength is an important characteristic of concrete. In the marine environment, however, concrete strength may not be the primary design criterion since properties such as durability, permeability, and wear resistance become more critical. If the engineer provides for these latter considerations when designing a concrete mix, adequate strength is often assured. In this section, the variables that influence each of the above mentioned properties will be examined. Guidelines will then be presented concerning mix design specifications.

Durability

The useful life of concrete is normally limited by the disintegration effects of freezing and thawing, wetting and drying, heating and cooling, chemical attack, and abrasion. To be durable, concrete must be able to withstand these types of exposure so that an acceptable service life is attained. Durability may be enhanced by choosing the proper type cement and aggregate. Other variables include aggregate gradation, water-cement ratio, and the use of entrained air or water reducing admixtures. Cement types have been investigated by Hubbell and Kulhawy (1979a) and will not be addressed here.

Aggregate forms by far the major portion of the concrete, and the durability of the mix is directly proportional to the durability of the aggregate. For this reason, concrete specifications require a well graded aggregate of proven durability (Cordon, 1979; ACI, 1978a; Bureau of Reclamation, 1975). If possible, "proof" of durability should come from field experience. Alternatively, a laboratory procedure such

as the Magnesium Sulfate Soundness test (ASTM C88-76) may be used to verify aggregate stability. As illustrated by Figure 4.1, concrete durability is increased in mixes using a low water-cement ratio and incorporating some degree of entrained air. Water reducing agents, as implied by their name, allow for greater durability by further reducing the water content while maintaining workability.

Permeability

All concrete is porous to some degree because of the presence of voids within the mix. These voids are caused by the loss of water during drying, the decrease in volume of the cement paste during hydration, and the voids incorporated intentionally through entrained air. As with other porous media, concrete is permeable to air, water, and water soluble corrosives. Since these agents adversely affect the weathering and durability of marine concrete, it is advantageous to proportion the mix for minimum permeability. Fortunately, the water-cement ratio is again the primary factor involved. It should be kept as low as possible while still maintaining a workable mix (Murdock and Blackledge, 1968). Figure 4.2 shows the relationship between the water-cement ratio and the coefficient of permeability for various maximum aggregate sizes. To assure low concrete permeability, good aggregates must be used that are sound and of low porosity. The aggregate should also be proportioned so that maximum density is achieved. A convenient way to represent this concept is through the use of gradation charts (Figures 4.3 and 4.4). Figure 4.3 shows two gradation curves drawn on a gradation chart which plots the percent of a test sample passing various sieve sizes versus the log of the aperture particle size. Figure 4.4 on the other hand is a gradation chart of percent passing versus

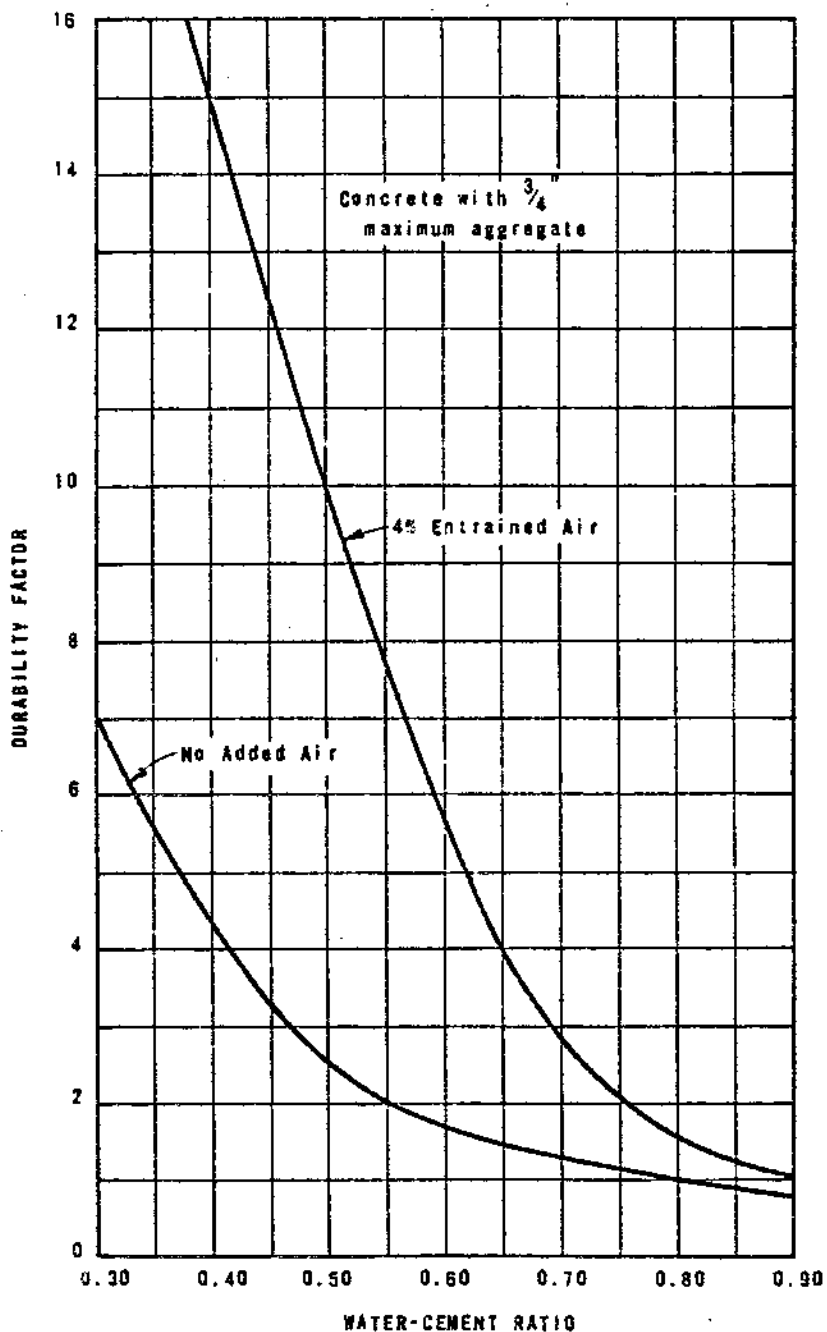

Figure 4.1 Relation Between Durability and Water-Cement Ratio for Air-Entrained and Non-Air-Entrained Concrete (Bureau of Reclamation, 1975, p. 35)

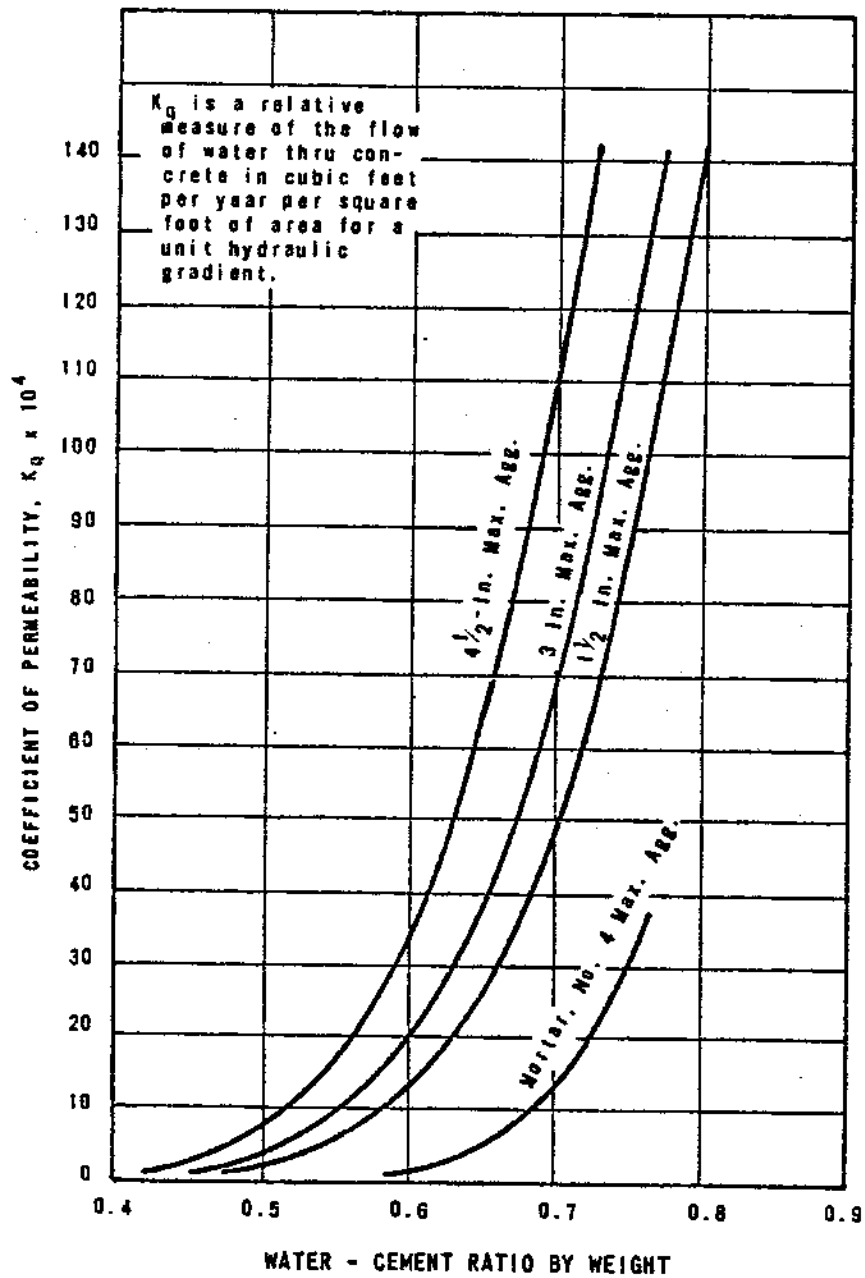

Figure 4.2 Relationship Between Coefficient of Permeability and Water-Cement Ratio, for Mortar and Concrete of Three Aggregate Sizes (Bureau of Reclamation, 1975, p. 37)

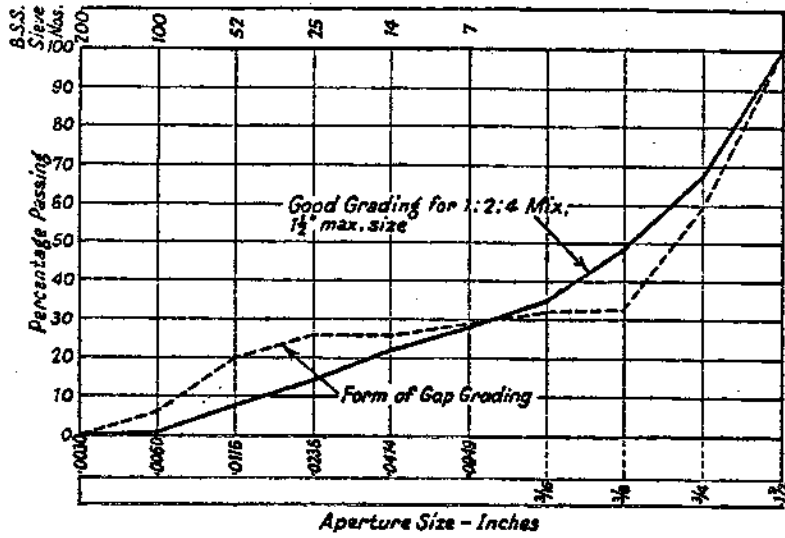
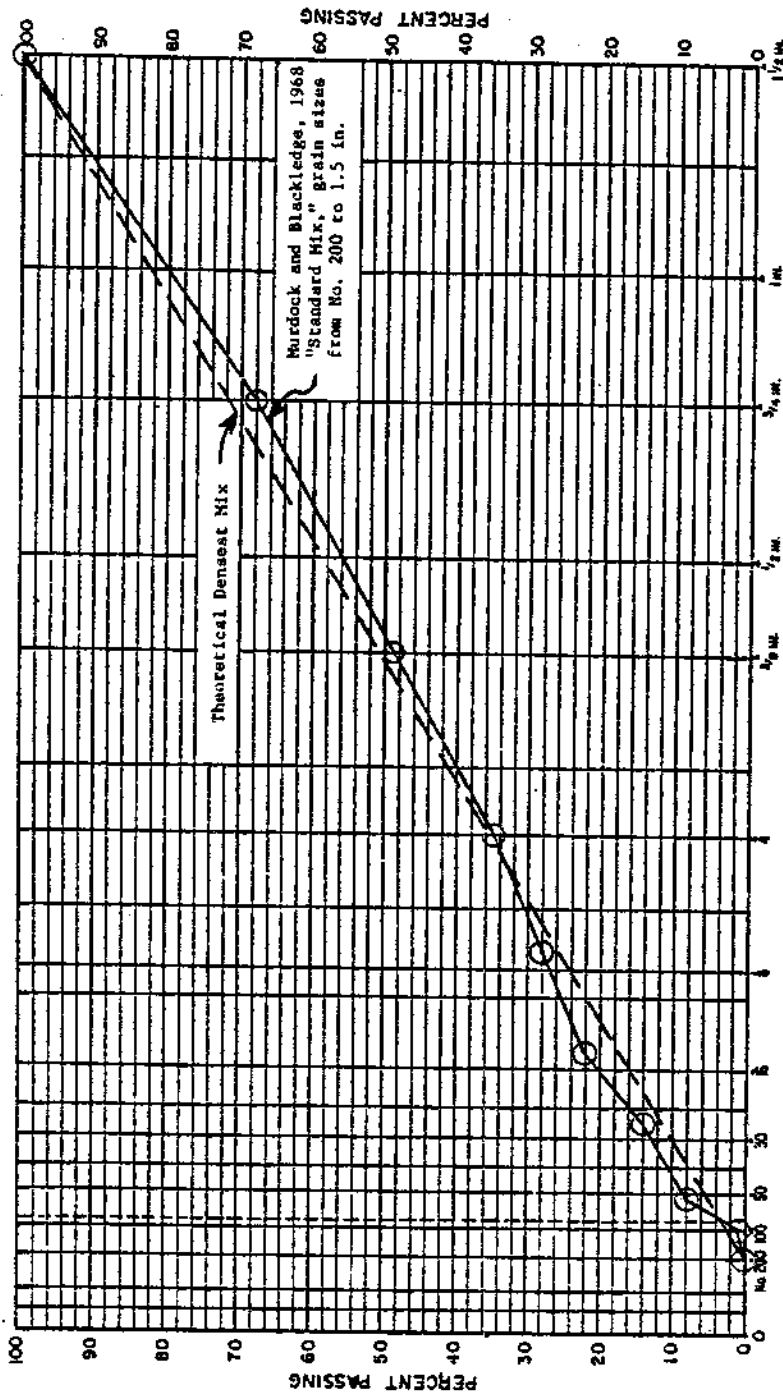

Figure 4.3 Conventional Gradation Chart for Concrete Aggregate (Murdock and Blackledge, 1968, p. 43)



SIEVE SIZES RAISED TO 0.45 POWER

Figure 4.4 Gradation Chart for Concrete Aggregate Using Sieve Sizes to the 0.45 Power

aperture size raised to the 0.45 power. The gradation curve which is suggested by Murdock and Blackledge (1968) as a standard mix for the 1.5 in. (38 mm) maximum aggregate size has been replotted on the second chart. Note that while the shape of the curves is concave up on the standard chart, it is nearly a straight line when redrawn. It has been found experimentally that a straight line connecting the maximum and minimum allowable aggregate sizes on the 0.45 power chart (demonstrated by the broken line) represents a gradation that will have the maximum theoretical density. The designer has only to choose the maximum aggregate size and plot the line on the graph to estimate the percentages of each aggregate size when specifying a dense mix.

Two final factors that influence concrete permeability are age and conditions during curing. Permeability decreases as the concrete ages and approaches a complete "set". Since the outer layer of the concrete is the most critical for permeability (because it covers and protects the reinforcing steel), it is very important to keep the surface moist during the cure, particularly during the first few days (Murdock and Blackledge, 1968).

Abrasion Resistance

Abrasion resistance is directly related to the crushing strength of the concrete since concentrated stresses tend to chip and spall the surface. Generally, the concrete with the highest compressive strength will have the greatest wear resistance. The susceptibility of the aggregate to chemical attack may also be important. Limestone, for example, dissolves in an acid environment which often occurs in polluted areas.

Strength

Concrete strength is highly variable and is dependent on such factors as water-cement ratio, curing, degree of compaction, aggregate properties and admixtures. Water-cement ratio is again the most important single factor in determining concrete strength. Figure 4.5 illustrates the decrease in strength that occurs as the water-cement ratio increases. The lowest water-cement ratio that may be used while still providing acceptable workability will result in the strongest mix, all other factors staying constant. It is convenient that at the same time durability, permeability, and wear resistance are also optimized. The influence of curing on strength is very complex and can be best illustrated with the aid of two figures. Figure 4.6 demonstrates the effect of moist curing on strength gain with age, while Figure 4.7 indicates the temperature dependency of concrete strength. Optimum strength may be achieved by moist curing at a relatively warm temperature (70°F). The summer months are therefore the best season for concrete construction with respect to proper curing in the field.

Thorough compaction is necessary to densify the mix and remove unwanted void spaces. It can be carried to the extreme, however, since vibration will segregate the aggregate and reduce strength. Aggregate properties such as surface texture, particle size, particle shape, and aggregate-paste bond influence concrete strength. Their effects are somewhat interrelated and tend to have compensating results. For example, rough surface textures enhance concrete strength (assuming a cement paste of constant water-cement ratio) because of better bonding, but a greater paste content is required. Angular particles also increase strength by creating an "aggregate interlock" but require higher water-

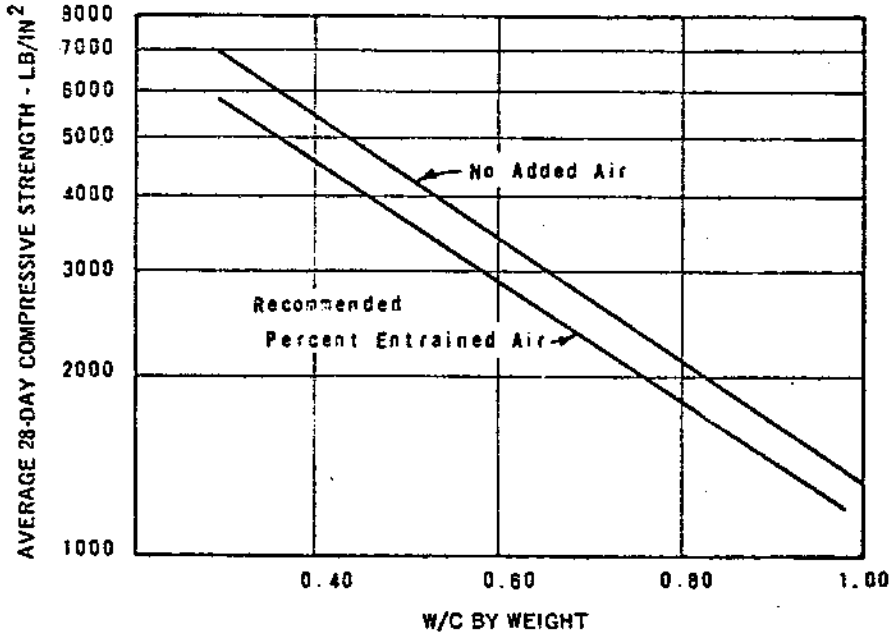

Figure 4.5 Strength in Relation to Water-Cement Ratio for Air-Entrained and Non-Air-Entrained Concrete (Bureau of Reclamation, 1975, p. 38)

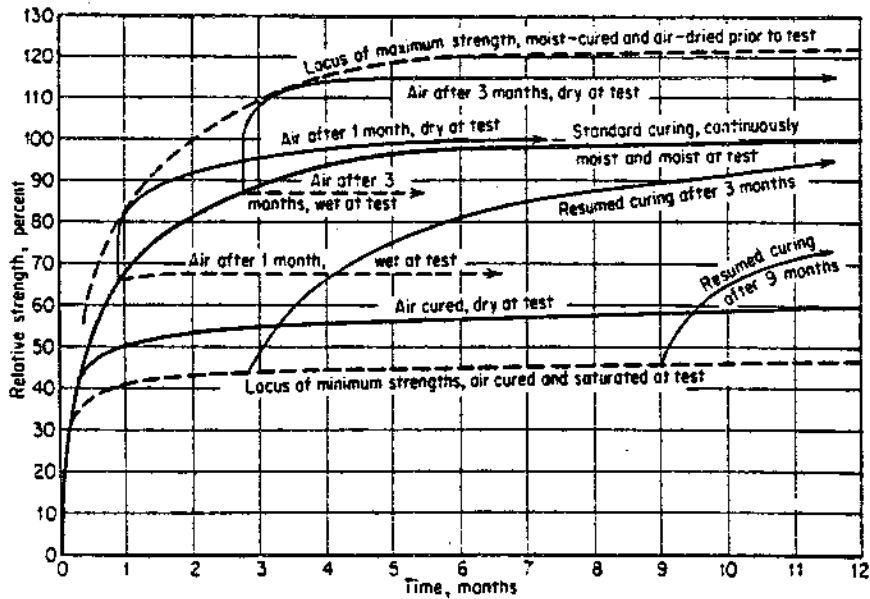

Figure 4.6 Effect of Moist Curing on the Strength of Concrete (Bureau of Reclamation, 1975, p. 120)

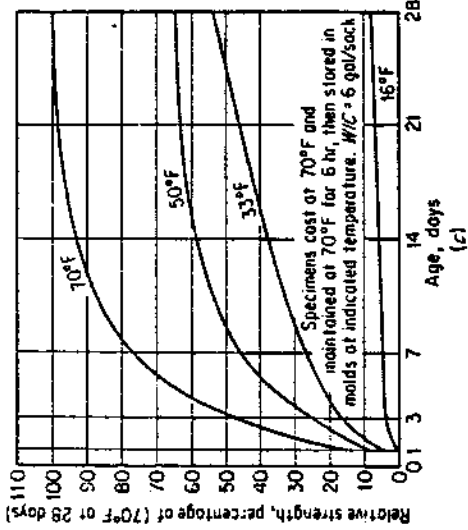
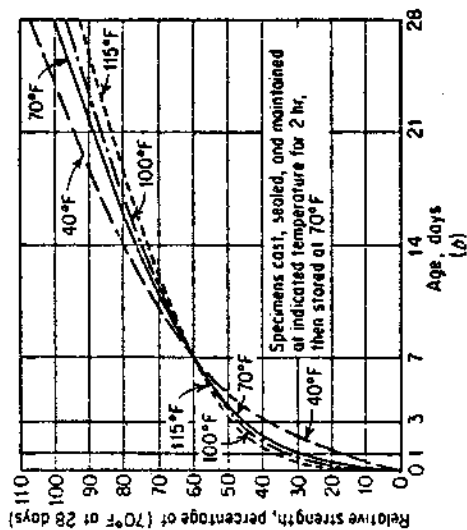
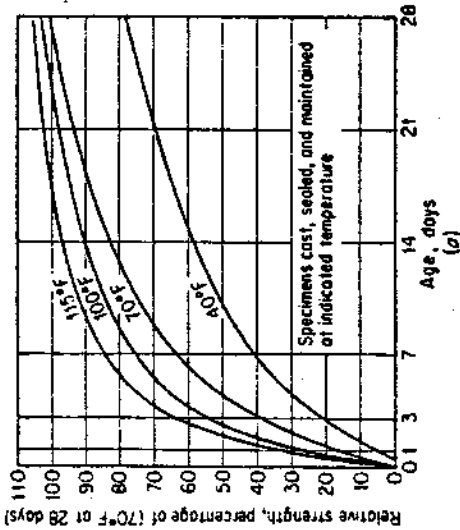

Figure 4.7 Temperature Dependency of Concrete Strength (Bureau of Reclamation, 1975, P. 121)



cement ratios for workability. The lower water-cement ratio obtained with a rounded aggregate balances the better strength producing properties of a crushed aggregate. In general, high quality concrete is assured by using strong, clean, sound aggregate proportioned for a dense gradation.

Air entrainment and water reducing agents are the most common admixtures used in marine concrete. Entrained air reduces the strength of the concrete by about 5 percent for each percent of entrained air. Figure 4.5 demonstrates this strength loss graphically. Water reducing admixtures have become widely accepted as a means of increasing slump and workability without compromising strength or quality. They may also be used to decrease the water content of a mix without reducing the slump or workability.

Recommendations for Marine Concrete

Marine concrete must be of high quality if it is to resist the environmental and structural loads imposed on it and still provide a useful service life. Specifications for marine concrete naturally place limits on many of the parameters previously discussed as influencing concrete properties. Table 4.1 presents a summary of the recommendations of three committees concerned with the quality of concrete used in marine structures. Note that while these guidelines aid in producing a high quality concrete, the final mix proportions should always be based on the adjustment of trial mixes whenever possible. Properties peculiar to each aggregate type must be taken into consideration. Step by step procedures for proportioning normal, heavyweight, and lightweight concretes are presented in the 1977 American Concrete Institute standards

Table 4.1 Design Recommendations for Marine Structures (Browne, 1980, p. 190)

SPECIFIC-TION	EXPOSURE CONDITION	CEMENT TYPE	MAX. WATER/CEMENT RATIO (by weight)	MIN. CEMENT CONTENT		MIN. CHARACTERISTIC STRENGTH IF 28 DAYS N/mm^2	AIR ENTRAINMENT %	PERMEABILITY $w/100$	NOMINAL COVER (mm)	
				40mm min.	20mm min.				Reinforcing	Prestressing
F.I.P. (1977)	Submerged	OPC	0.45 (preferably 0.4)	300 kg/m^3	200 kg/m^3	40 (45 if subject to scour)	-	-	60	75
	Tidal and above.	OPC with 0.1% SA		360 kg/m^3	260 kg/m^3		-	4-7	-	75
D.N.V. (1977)	Submerged	Any	0.45 (preferable 0.4)	300 kg/m^3	400 kg/m^3	45	-	Should not normally exceed 10-15	50	100
	Tidal and above.	Any		400 kg/m^3	400 kg/m^3		3-5	-	70	100
CP110 (1972)	Marine	OPC	0.45	290 kg/m^3	190 kg/m^3	-	-	-	60	60
	Protected from direct exposure to marine atmosphere.	*		320 kg/m^3	260 kg/m^3	30**	-	-	60*	75*
B.S.I. BS5493:1970	Directly exposed to salt water or salt water spray to marine atmosphere.	OPC RSC SRPC PRPC	0.4	320 kg/m^3	260 kg/m^3	30**	-	-	60*	75*
	Subject to severe abrasion.	PRPC		400	400	40	To be considered for splash zone	-	75**	100**

* OPC Ordinary Portland Cement
 RSC Rapid Hardening Portland Cement
 SRPC Sulphate Resisting Portland Cement
 PRPC Portland Blast Furnace Cement
 **Min. for Freshwater Concrete 400 kg/m^3
 + Submerged
 **External Splash and Atmospheric

F.I.P. - Federation Internationale De La Precontrainte
 D.N.V. - Det Norske Veritas
 CP110 - British Standards Institution, Code of Practice

(ACI 211.1-77 and ACI 211.2-69).

4.2 STEEL

Steel is a very common material in modern civil engineering. It is estimated that steel is used in at least a million applications (Cordon, 1979). With respect to coastal structures, the steel products of interest are structural steel, reinforcing steel, and hardware such as bolts. While many steel alloys are available for high strength or corrosion resistance, the most common steel is an all purpose carbon grade referred to as "mild steel" (ASTM designation A36). Table 4.2 lists the various steel alloys available, giving their ASTM designations and common uses. While each of these alloys may hold advantages over A36 structural carbon steel, they should not be used indiscriminantly since they may cost significantly more. Table 4.3 indicates the availability of the different steel types for structural shapes, plates and bars. Note that the table includes the ultimate and yield stresses for each alloy listed. Other steel properties that are important are the modulus of elasticity (29.1×10^6 psi or 200 GN/m^2) and density (490 pcf or 77.2 kN/m^3).

Steel's low cost and excellent engineering properties compensate for its one major flaw; corrosion. The process of corrosion and the methods of protecting steel from its effects are dealt with in detail by Hubbell and Kulhawy (1979a) and will not be discussed further here.

4.3 WOOD

Wood was one of the very first materials used by man for the purpose of construction, and its unique engineering properties will make it

Table 4.2 Steel Alloys and Uses (Cordon, 1979, pp. 155, 156)

ASTM designation	Product	Use
A36	Carbon-steel shapes, plates and bars	Welded, riveted, and bolted construction; bridges, buildings, towers, and general structural purposes
A53	Welded or seamless pipe, black or galvanized	Welded, riveted, and bolted construction; primary use in buildings, particularly columns and truss members
A242	High-strength, low-alloy shapes, plates, and bars	Welded, riveted, and bolted construction; bridges, buildings, and general structural purposes; atmospheric-corrosion resistance about four times that of carbon steel; a weathering steel
A245	Carbon-steel sheets, cold- or hot-rolled	Cold-formed structural members for buildings, especially standardized buildings; welded, cold-riveted, bolted, and metal-screw construction
A374	High-strength, low-alloy, cold-rolled sheets and strip	Cold-formed structural members for buildings, especially standardized buildings; welded, cold-riveted, bolted, and metal-screw construction
A440	High-strength shapes, plates, and bars	Riveted or bolted construction; bridges, buildings, towers, and other structures; atmospheric-corrosion resistance double that of carbon steel
A441	High-strength low-alloy manganese-vanadium steel shapes, plates and bars	Welded, riveted, or bolted construction but intended primarily for welded construction; bridges, buildings, and other structures; atmospheric-corrosion resistance double that of carbon steel
A446	Zinc-coated (galvanized) sheets in coils or cut lengths	Cold-formed structural members for buildings, especially standardized buildings; welded, cold-riveted, bolted, and metal-screw construction
A500	Cold-formed welded or seamless tubing in round, square, rectangular, or special shapes	Welded, riveted, or bolted construction; bridges, buildings, and general structural purposes
A501	Hot-formed welded or seamless tubing in round, square, rectangular, or special shapes	Welded, riveted, or bolted construction; bridges, buildings, and general structural purposes
A514	Quenched and tempered plates of high yield strength	Intended primarily for welded bridges and other structures; welding technique must not affect properties of the plate, especially in heat-affected zone
A529	Carbon-steel plates and bars to $\frac{1}{2}$ in thick	Buildings, especially standardized buildings; welded, riveted, or bolted construction
A570	Hot-rolled carbon-steel sheets and strip in coils or cut lengths	Cold-formed structural members for buildings, especially standardized buildings; welded, cold-riveted, bolted, and metal-screw construction
A572	High-strength low-alloy columbian-vanadium steel shapes, plates, sheet piling, and bars	Welded, riveted, or bolted construction of buildings in all grades; welded bridges in grades 42, 45, and 50 only
A588	High-strength low-alloy steel shapes, plates, and bars	Intended primarily for welded bridges and buildings; atmospheric-corrosion resistance about four times that of carbon steel; a weathering steel
A606	High-strength, low-alloy hot- and cold-rolled sheet and strip	Intended for structural and miscellaneous purposes where savings in weight or added durability are important

Table 4.3 Availability of Shapes, Plates and Bars According To ASTM Structural Steel Specifications (AISC, 1980, p. 1-5)

Steel Type	ASTM Designation	F _y Minimum Yield Stress (ksi)	F _u Tensile Stress ^a (ksi)	Shapes					Plates and Bars										
				Group per ASTM A6					To 1/2" Incl.	Over 1/2" to 3/8" Incl.	Over 3/8" to 1 1/4" Incl.	Over 1 1/4" to 1 1/2" Incl.	Over 1 1/2" to 2" Incl.	Over 2" to 2 1/2" Incl.	Over 2 1/2" to 4" Incl.	Over 4" to 5" Incl.	Over 5" to 6" Incl.	Over 6" to 8" Incl.	Over 8"
				1	2	3	4	5											
Carbon	A36	32	58-80																
		36	58-80 ^c	X	X	X	X	X	X	X	X	X	X	X	X	X	X	X	X
	A529	42	60-85	X	X	X	X	X	X	X	X	X	X	X	X	X	X	X	X
High-Strength Low-Alloy	A441	40	60												X	X	X	X	
		42	63			X	X					X	X	X	X	X	X	X	
		46	67			X	X					X	X	X	X	X	X	X	
		50	70	X	X	X	X	X	X	X	X	X	X	X	X	X	X	X	X
	A572-Grade	42	42	60	X	X	X	X	X	X	X	X	X	X	X	X	X	X	X
		50	50	65	X	X	X	X	X	X	X	X	X	X	X	X	X	X	X
		60	60	75	X	X	X	X	X	X	X	X	X	X	X	X	X	X	X
		65	65	80	X	X	X	X	X	X	X	X	X	X	X	X	X	X	X
Corrosion-Resistant High-Strength Low-Alloy	A242	42	63			X	X					X	X	X	X	X	X		
		46	67			X	X					X	X	X	X	X	X		
		50	70	X	X	X	X	X	X	X	X	X	X	X	X	X	X	X	X
	A588	42	63												X	X	X	X	
		46	67												X	X	X	X	
		50	70	X	X	X	X	X	X	X	X	X	X	X	X	X	X	X	X
Quenched & Tempered Alloy	A514 ^d	90	100-130											X	X	X	X		
		100	110-130												X	X	X	X	

^a Minimum unless a range is shown.
^b Includes bar-size shapes.
^c For shapes over 426 lbs./ft., minimum of 58 ksi only applies.
^d Plates only.
 X Available.
 □ Not available.

indispensable in the future. High strength in addition to low weight gives wood a strength to weight ratio much larger than for steel or concrete (Cordon, 1979). Wood is easily worked using a variety of tools and it is readily available in standard sizes and grades. Timber structures are attractive, inexpensive, and may be very durable if properly treated. Wood structural members also have excellent shock resistance. The following section first examines the nature of wood with respect to its growth, composition, defects, and species. Second, the variables that influence strength and shrinkage are discussed. Third, the response of wood to load duration (both short and long term) and its fire resistance are investigated, and finally, laminated wood members are presented.

Growth, Composition, Defects and Species

Wood is a cellular material growing naturally in response to constantly changing conditions such as moisture regime, soil status, and growing space. It is an orthotropic substance composed of long tube-like cells (Figure 4.8), having unique and independent mechanical properties along each of three mutually perpendicular axes; longitudinal, radial, and tangential (FPL, 1974). Figure 4.9 depicts these axes with respect to the grain direction and growth rings. Because of this special case of anisotropy, extensive testing would have to be conducted to determine separately all of the mechanical properties of wood on each of its axes. To compound the problem, these data must be acquired on many different species of wood. In practice, wood is only used in simple tension or compression parallel to the grain, and simple bending along its strong axis, so the amount of testing is greatly reduced.

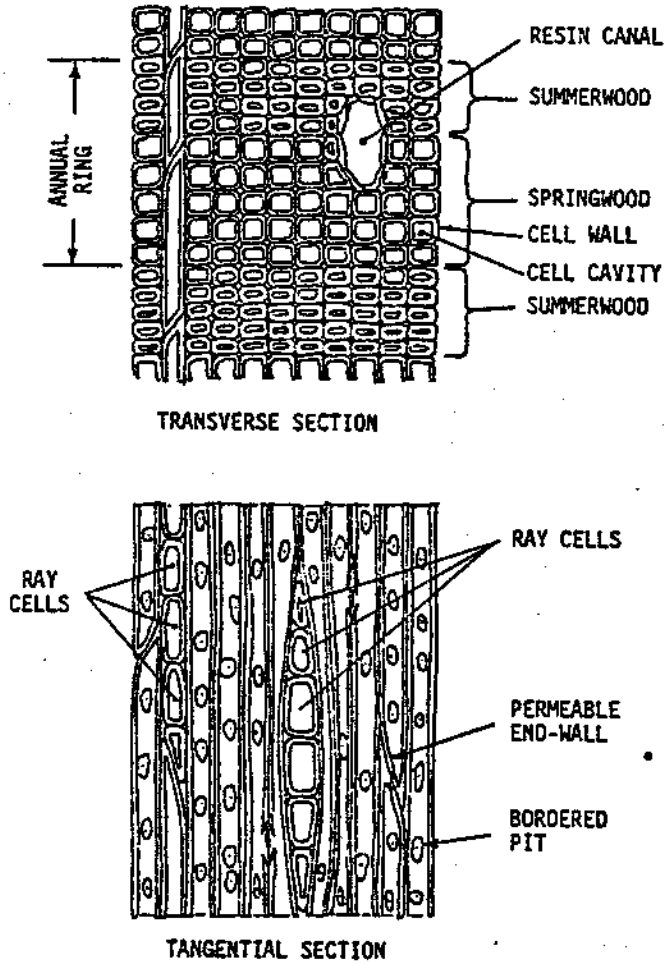

Figure 4.8 Transverse (RT) and Tangential (LT) Sections of a Softwood (ASCE, 1975, p. 3)

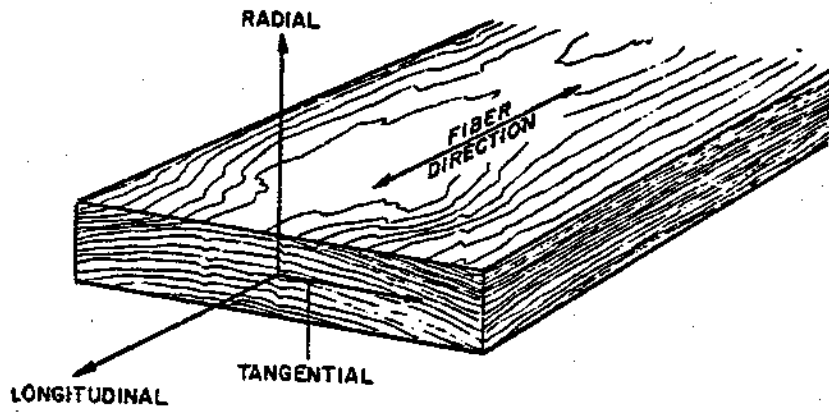

Figure 4.9 The Orthotropic Axes of Wood
(ASCE, 1975, p. 33)

For the purposes of testing, small specimens of "clear" wood (free of defects) are used that are assumed to be homogeneous. In fact, because of the variable environmental conditions noted previously, the mechanical properties of "clear" wood may be highly variable themselves. On a larger scale however, the behavior of wood members is often controlled by defects such as knots, cross-grain, checks and splits. Other imperfections, including insect damage, reaction wood, compression failures, pitch, and bark pockets may also reduce the strength and flexibility of wood members. Wood properties are also very species dependent. Hardwood species include the deciduous, broad-leaved trees that shed their leaves in the fall in cooler climates. Softwoods on the other hand, are conifers that are "needle-leaved" and reproduce through seed bearing cones. These "evergreen" softwoods make up most of the commercially important species because of their rapid growth and straight stems. The species available in the United States are listed in Table 4.4. Note that most of the species are softwoods and that while most hardwoods have a greater specific gravity (i.e., greater density), there are exceptions. Specific gravity is a useful index of the mechanical properties of wood, the primary one being strength.

Parameters Influencing Strength and Shrinkage

Tests of small, clear, straight-grained wood samples establish an upper bound on the strength of an actual wood member. Grading rules are then applied to reduce the allowable strength of the member caused by defects and other strength-reducing characteristics. The basis for lumber grading in the United States is the American Lumber Standard

Table 4.4 Average Specific Gravity and Average Weight (pcf) for Commercially Important Species (National Forest Products Association, 1977, p. 4)

Species	HARDWOOD/ Softwood	Specific Gravity	Weight per Cubic Foot
Ash (commercial white)	H	0.62	40.5
Aspen	H	0.40	27.2
Balsam Fir	S	0.38	25.5
Beech	H	0.68	46.1
Birch, Sweet and Yellow	H	0.66	44.0
Black Cottonwood	H	0.33	22.2
California Redwood (Close grain)	S	0.42	29.2
California Redwood (Open grain)	S	0.37	24.8
Coast Sitka Spruce	S	0.39	26.6
Coast Species	Mix	0.39	26.6-34.3
Cottonwood, Eastern	H	0.41	28.5
Douglas Fir - Larch	S	0.51	34.3
Douglas Fir South	S	0.48	32.7
Eastern Hemlock - Tamarack	S	0.45	30.2
Eastern Spruce	S	0.43	28.9
Eastern White Pine	S	0.38	25.5
Eastern Woods	Mix	0.38	25.5-31.2
Engelmann Spruce - Alpine Fir	S	0.36	24.3
Hem-Fir	S	0.42	28.1
Hickory and Pecan	H	0.75	48.2
Idaho White Pine	S	0.40	26.0
Lodgepole Pine	S	0.44	29.8
Maple, Black & Sugar	H	0.66	44.5
Mountain Hemlock	S	0.47	32.8
Northern Aspen	H	0.42	28.7
Northern Pine	S	0.46	31.2
Northern Species	Mix	0.35	24.2-34.3
Northern White Cedar	S	0.31	22.2
Oak, Red and White	H	0.67	47.3
Ponderosa Pine (North)	S	0.49	33.0
Ponderosa Pine - Sugar Pine	S	0.42	28.6
Red Pine (North)	S	0.42	28.7
Sitka Spruce	S	0.43	29.1
Southern Cypress	S	0.48	33.5
Southern Pine	S	0.55	37.3
Spruce - Pine - Fir	S	0.42	26.9
Sweetgum & Tupelo	H	0.54	35.6
West Coast Woods (Mixed Species)	Mix	0.35	24.2-34.3
Western Cedars	S	0.35	24.2
Western Hemlock	S	0.48	31.8
Western White Pine	S	0.40	27.3
White Woods (Western Woods)	Mix	0.35	24.2-34.3
Yellow Poplar	H	0.46	29.4

(1 pcf = 0.1571 kN/m³)

PS 20-70 published by the Board of Review of the American Lumber Standards Committee (1970). After visual inspection, each grade is given a commercial designation (No. 1, No. 2, etc.). This system allows the lumber yard to supply the user with the proper grade corresponding with the strength values used in design. The material properties of visually graded structural lumber to be used in design of wood structures is presented by the National Forest Products Association (1978a).

Some of the more important parameters concerning the strength of wood members are specific gravity, growth characteristics, defects, moisture content, temperature, grain orientation, chemicals, and decay. Of these, the important growth characteristics and defects have been mentioned briefly. The manner in which each defect or growth irregularity affects timber strength will not be addressed since the material properties recommended by the National Forest Products Association (1978a) have been adjusted according to the appropriate grading rule.

Specific gravity is related to the amount of woody fiber that a piece of wood contains. Regardless of species, the specific gravity of this woody fiber (primarily cellulose) is about 1.5 (FPL, 1974). The specific gravities in Table 4.4 are considerably less than 1.5 because part of the volume of a piece of wood is occupied by all cavities and pores. Logically, lower void volumes will be associated with thicker cell walls that should result in greater strength. This is found to be true as the tensile and compressive strengths of wood increase with specific gravity for clear, straight-grained pieces that are free of defects (Patton, 1976). It should be noted however that specific gravity also reflects the presence of gums, resins, and various imperfections that may actually reduce strength while increasing density.

When fresh cut wood begins to lose moisture in the seasoning (drying) process, the cell walls remain saturated until the free water within the cell cavities has been evaporated. The Fiber Saturation Point (FSP) may then be defined as the state where free water evaporation is complete but the cell walls are still saturated. For most species, this occurs between 25 and 30 percent moisture content (National Forest Products Association, 1978b). While variations in the moisture content above the FSP have little effect on the strength of wood, the mechanical properties will increase with a decrease in moisture content below the FSP (Table 4.5). The location of wood members used in harbor structures ranges from totally submerged to above the water but open to the weather. Since these members will tend to come to equilibrium with their environment, their moisture contents can be expected to vary from saturated to semi-dry (15 to 20% moisture content).

Some provision must be made to reduce the design strengths of timber members when they must serve at high moisture contents. The National Forest Products Association (1978a) specified maximum moisture contents for various wood species, and presents reduction factors to be applied to the tabulated strength properties when these moisture contents are exceeded.

The drying process may also be important since wood strength may be permanently reduced by prolonged temperatures above 150°F (65°C). Figure 4.10 demonstrates the effect of extended heating on modulus of rupture. Temperature extremes may be expected during the oven drying of lumber and during the pressure preservative treatment process. In the latter case, the maximum temperature level and duration are respectively 240°F (115°C) and 10-15 hours (MacLean, 1952). As shown by

Table 4.5 Average Change in Clear Wood Strength Properties for a 1-percent Change in Moisture Content Below Fiber Saturation Point (National Forest Products Association, 1977, p. 6)

Property	Change per 1-percent change in moisture content (percent)
Static bending	
Fiber stress at proportional limit	5
Modulus of rupture	4
Modulus of elasticity	2
Work to proportional limit	8
Work to maximum load	0.5
Impact bending, height of drop causing complete failure	0.5
Compression parallel to grain	
Fiber stress at proportional limit	5
Maximum crushing strength	6
Compression perpendicular to grain, fiber stress at proportional limit	5.5
Hardness, end grain	4
Hardness, side grain	2.5
Shear parallel to grain	3
Tension perpendicular to grain	1.5

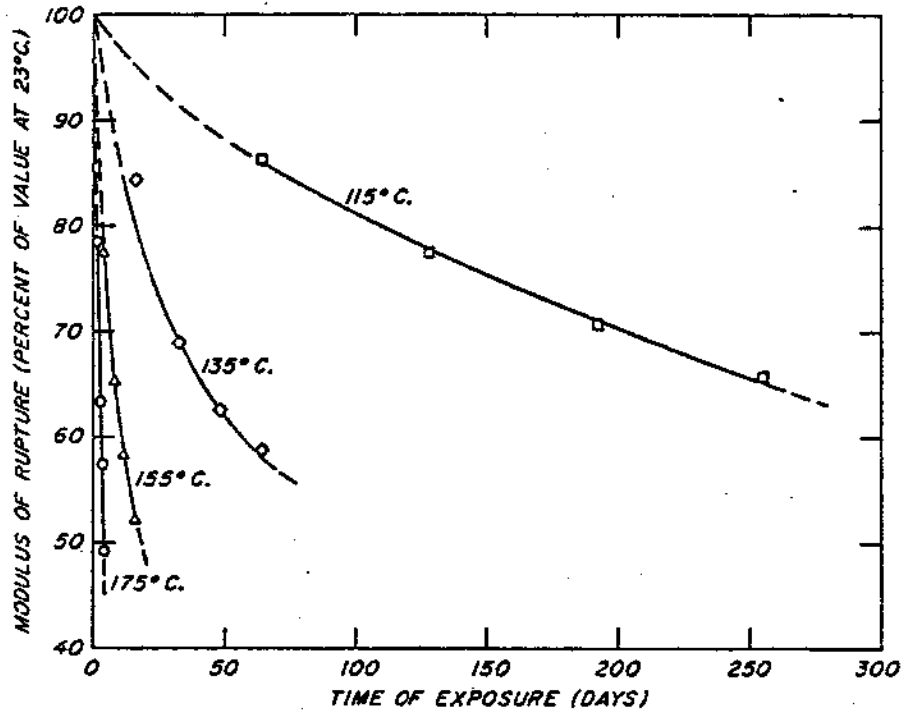

Figure 4.10 Permanent Effect of Dry Heat on the Modulus of Rupture of Dry Wood (ASCE, 1975, p. 49)

Figure 4.10, the damage incurred by such heating should be negligible.

In structural design, wood members are commonly loaded both parallel and perpendicular to the longitudinal axis of the member. In the first case, growth ring orientation is not important as long as the member is straight-grained. If the fibers do not run parallel to the longitudinal axis (as in the case of cross or spiral grain), a reduction of working stress has been made through application of the grading rules. Growth ring orientation is important, however, when the member is loaded in bending (stress perpendicular to the longitudinal axis). The orientation of the stress with respect to the growth rings may range from tangential (0 degrees) to radial (90 degrees) as illustrated in Figure 4.11.

Depending on the portion of the log it was sawn from, the orientation of the growth rings relative to the faces of the member may range from pure tangential to pure radial. As such, grain orientation must be incorporated in the grading rules when rating a member for its allowable working stress.

The recommended wood strength properties (National Forest Products Association, 1978a) are all based on edgewise use (bending stress applied to the narrow face), and using these values for flat-oriented members would be incorrect. Again, footnotes are provided to adjust the tabulated design values for grain orientation.

The effects of chemicals on the mechanical properties of wood depends primarily on the specific type of chemical involved (FPL, 1974). Basically, they may be separated into two groups: swelling and non-swelling liquids. Petroleum oils and creosote are examples of non-swelling chemicals since they cause no volume change of the wood and

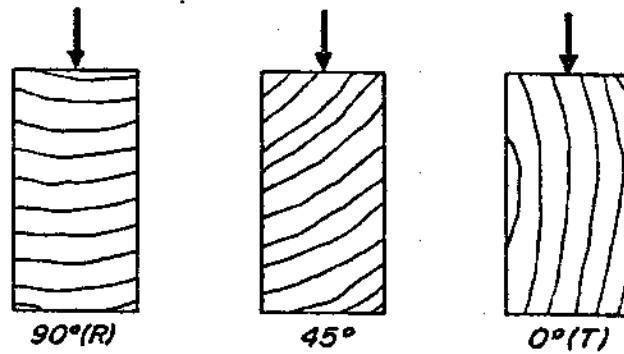

Figure 4.11 Load Direction in Relation to Annual Growth Ring Direction (Forest Products Laboratory, 1974, p. 4-29)

therefore have no appreciable effect on properties. Liquids that cause swelling on the other hand (water, alcohol, and organic solvents for example) may reduce properties even though they do not chemically degrade the wood (FPL, 1974). The loss of properties is a function of the degree of swelling and the process is reversible upon removal of the swelling liquid. Obviously there will be water present in the marine environment so some volume change of structural wood members is to be expected. Chemicals that act to decompose the wood fiber (alkaline solutions and non-oxidizing acids) result in a permanent reduction in properties. While pollutants may cause some of these substances to be present in trace amounts in harbor waters, their concentrations are negligible and cause no damage. Water-borne preservative salts are now commonly applied to timber for marine use to provide resistance to decay and fire. Kiln drying usually follows the preservative treatment. While mechanical properties are essentially unchanged for pressure preservative salt treatments, the combined effects of fire retardants and kiln drying may reduce maximum load as much as 45 percent. A 10 percent reduction is often applied to the design modulus of rupture which is affected much less severely.

Decay is caused by a fungi that consumes the cellulose and lignin in the wood, seriously reducing strength. The rate of decay depends on moisture content, oxygen availability, and temperature (National Forest Products Association, 1978b). The process of decay and the treatment of wood to combat it is discussed by Hubbell and Kuhlhawy (1979a) and will not be addressed here.

Shrinkage is dependent primarily on moisture content. It begins when the free water in the cells has been evaporated (i.e., at the fiber saturation point FSP) and continues until the member comes into

equilibrium with its surroundings. The reverse process, expansion, is equally likely if excess moisture is available to be absorbed. Wood shrinkage is greatest in the direction of the annual growth rings (tangentially), somewhat less across the rings (radially), and very little along the grain (longitudinally) (National Forest Products Association, 1978b). Longitudinal shrinkage is negligible except for very long continuous members, or for abnormal wood which is usually excluded in well graded structural lumber. Typical shrinkage values are given in Table 4.6. Figure 4.12 is presented to illustrate that because of shrinkage, wood members will distort from their fresh cut shape.

The Effects of Load Duration

Wood has the property of carrying substantially greater maximum loads for short durations than for long durations of loading. The strength values tabulated by the National Forest Products Association (1978a) are based on the "normal duration" of loading which is defined as "the application of the full maximum normal design load for the duration of approximately ten years (either continuously or cumulatively) and/or the application of 90 percent of this full maximum design load continuously throughout the remainder of the life of the structure..." It is appropriate to increase the working stresses to recognize the resistance of wood to short duration loading. Figure 4.13 presents the duration of load adjustment factors for impact, wind, seven days load, and snow. It should be noted that these load modification factors do not apply to modulus of elasticity. Additionally, the National Forest Products Association (1978b) states that "the impact load duration increase factor does not apply when the member has been pressure impreg-

Table 4.6 Shrinkage Values of Wood (ASCE, 1975, p. 9)

Species	Shrinkage from Green to Oven-Dry Percentage of Green Size		
	Radial	Tangential	Volumetric
SOFTWOODS:			
Cedar, western red	2.4	5.0	6.8
Cedar, northern white	2.2	4.9	7.2
Douglas fir*	4.8	7.6	11.8
Firs, true (Hem-fir)*	4.5	9.2	13.0
Hemlock, eastern	3.0	6.8	9.7
Hemlock, western	4.2	7.8	12.4
Larch, western	4.5	9.1	14.0
Pine, eastern white	2.1	6.1	8.2
Pine, lodgepole	4.3	6.7	11.1
Pine, ponderosa	3.9	6.2	9.7
Pine, red	3.8	7.2	11.3
Pine, southern*	5.4	7.7	12.3
Pine, sugar	2.9	5.6	7.9
Pine, western (Idaho) white	4.1	7.4	11.8
Redwood, California	2.6	6.9	11.2
Spruce, eastern*	4.1	7.8	11.8
Spruce, Englemann	3.8	7.1	11.0
Spruce, Sitka	4.3	7.5	11.5
HARDWOODS:			
Alder, red	4.4	7.3	12.6
Ash*	5.0	8.1	15.2
Aspen*	3.5	7.9	11.8
Basswood	6.6	9.3	15.8
Beech	5.5	11.9	17.2
Birch, yellow	7.3	9.5	16.8
Cherry, black	3.7	7.1	11.5
Cottonwood, black	3.6	8.6	12.4
Hickory, pecan	4.9	8.9	13.6
Hickory, true*	7.7	12.6	19.2
Maple, sugar	4.8	9.9	14.7
Oak, white	5.6	10.5	16.3
Oak, red, northern	4.0	8.6	13.7
Oak, red, southern	4.7	11.3	16.1
Walnut, black	5.5	7.8	12.8

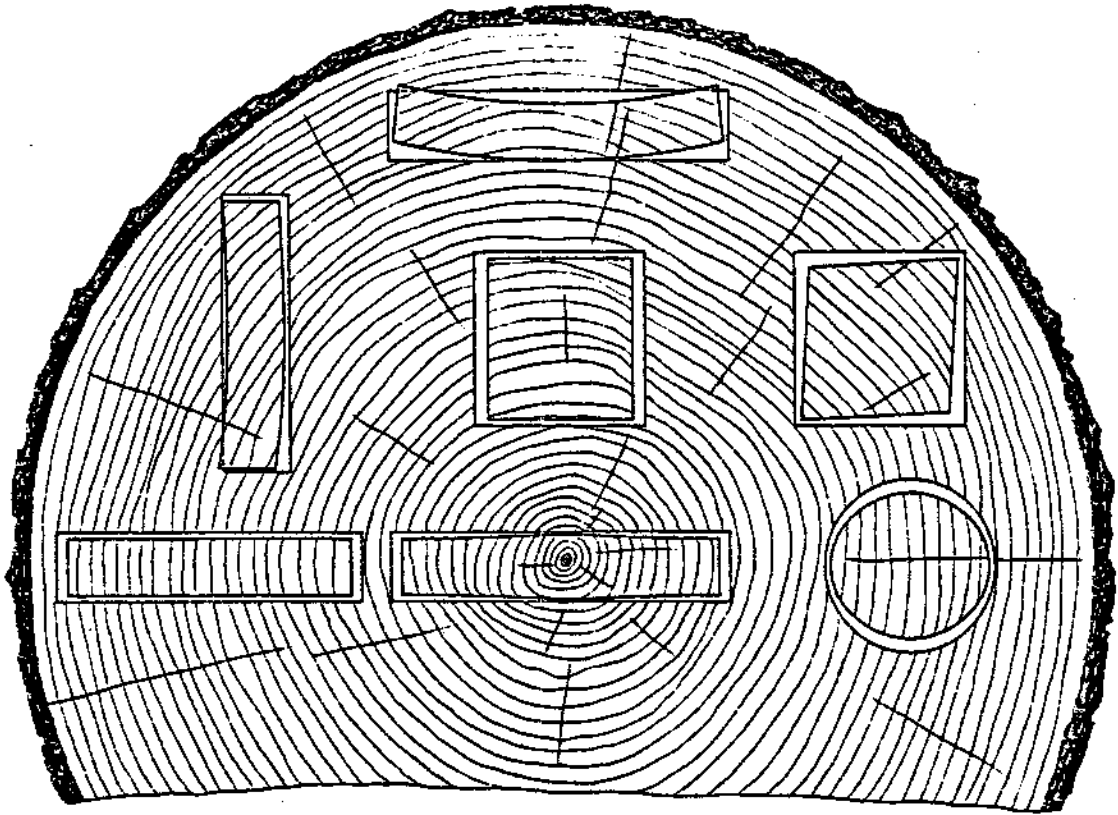

Figure 4.12 Characteristic Shrinkage and Distortion of Wood Shapes because of Annual Ring Direction (ASCE, 1975, p. 12)

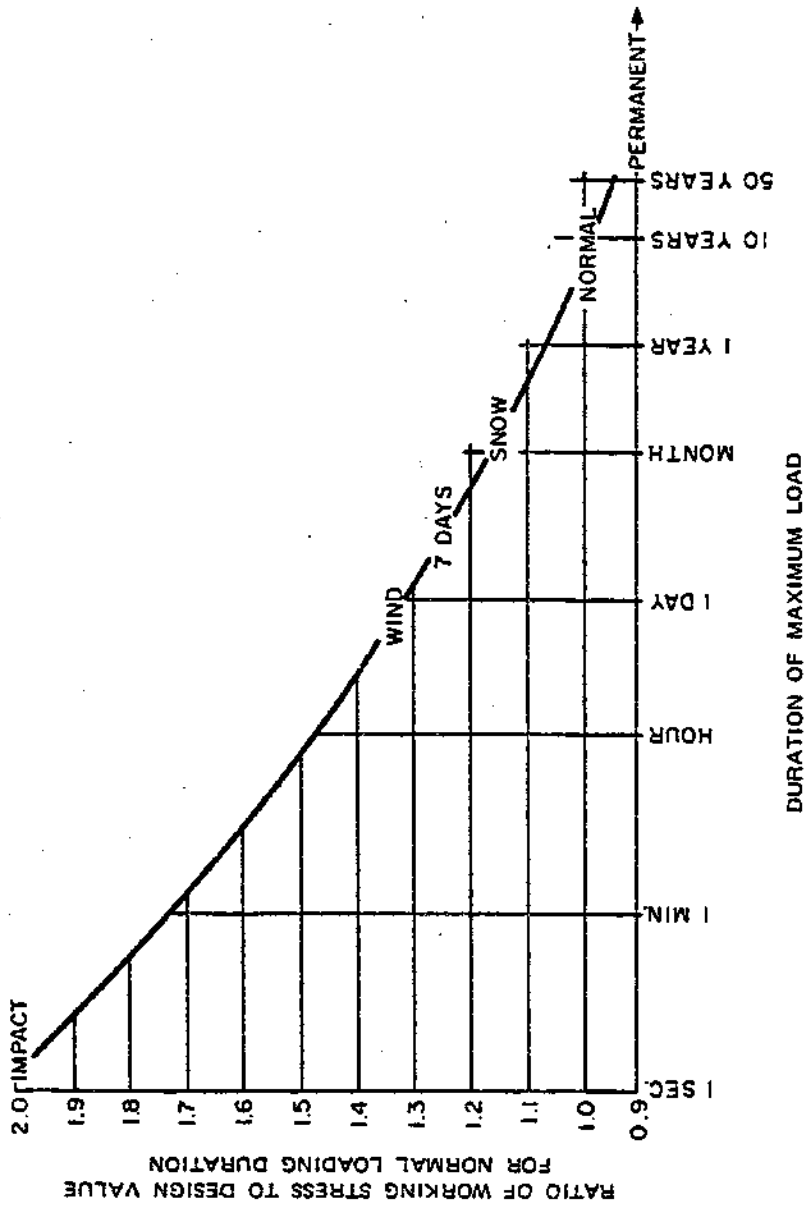

Figure 4.13 Adjustment of Wood Working Stresses for Load Duration (National Forest Products Association, 1977, p.13)

nated to the heavy retentions required for marine use." Loads of different durations may be combined using the following procedure

(National Forest Products Association, 1978b):

- (1) Determine the magnitude of each load that will occur on a structural member and accumulate subtotals of combinations of these loads of progressively shorter duration.
- (2) Divide each of these subtotals by the duration of load adjustment factor of the load having the shortest duration in the combination of loads under question.
- (3) The largest value thus obtained indicates which is the critical combination and the loading to be used in determining the structural element.

Long term loads on wood members result in permanent plastic deformation called "creep." As a rule of thumb, at design stress levels, the long time creep in wood structures can produce as much additional deflection as the original elastic deformation (ASCE, 1975). Creep is found to be a function of stress level, moisture content, and temperature. Figure 4.14 indicates that creep increases with increasing load. Ordinary climatic variations in temperature and moisture content may cause creep to increase. A two or three fold increase in creep may be expected for a temperature increase of about 50°F (28°C) and green wood may creep four to six times the initial deformation as it dries under load (FPL, 1974).

Fire Resistance and Wood Structures

A remarkable property of wood is its capacity to survive fires. It is in fact much more fire resistant than steel because of its low thermal conductivity and high specific heat (Patton, 1976). This seems to be incongruous with the common usage of wood as a fuel for heat. A

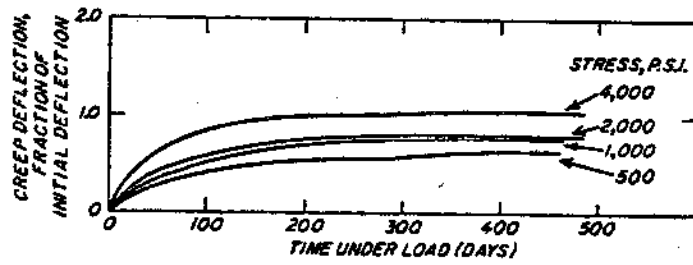

Figure 4.14 Experimentally Derived Creep Curve for Wood (ASCE, 1975, p. 50)

12 by 12 in. (300 by 300 mm) timber might require days to burn through while a steel member of the same strength could fail in less than an hour. Wood ignites at about 550°F (288°C) while steel is weakened considerably at that temperature. While the strength reduction of wood with respect to increased temperature has been discussed previously the loss of strength during a fire is primarily because of a loss of section as the member is consumed. Fire retardants improve the fire performance of wood by reducing the amount of flammable products released. Treated wood will not sustain a fire and is self-extinguishing once the heat source is removed. The rate of fire penetration through treated wood is about the same as for untreated wood. Fire-retardant treated wood is not usually used in harbor structures because of its cost, and because decay preservatives are deemed more important. Additionally, the potential for loss of life is greatly reduced compared to an enclosed building.

Laminated Wood Members

The lamination of wood products allows the designer to take advantage of the unique mechanical properties of wood without being penalized for defects. The two basic types of laminated wood products are structural glued laminated timber (or Glu-lam for short) and plywood. Glu-lam consists of 3 or more layers of lumber glued face-to-face so that the grain of all laminations is approximately parallel. Glu-lam members have many advantages over common timbers including higher working stresses, a wide variety of shapes, and a very attractive appearance. Primarily because of cost, they have not found an application in marine structures such as docks and piers. They are very useful

as arches and other roof-supporting members in covered structures. Plywood on the other hand is used both during the construction phase (as temporary concrete formwork, for example) and in the final product as decking or siding. It is made up of thin layers of wood glued together with the fibers arranged cross-wise for maximum strength. Plywood is commonly available in 4 by 8 ft (1.2 by 2.4 m) panels of varying thicknesses (0.25 to 1 in., 6 to 25 mm). Cordon (1979) recommends that where plywood will be exposed to moisture as in the case of marine structures, an exterior type should be used which is bonded with 100 percent waterproof glue.

4.4 ALUMINUM

In spite of its high cost, aluminum is becoming increasingly popular as a structural material on the waterfront. While aluminum and aluminum alloys have high strength and low weight as their prime assets, they are also very corrosion resistant because of an oxide layer that quickly forms upon exposure (Patton, 1976). Since aluminum is easily formed and machined, many attractive finishes are possible. Aluminum is used chiefly in prefabricated, modular construction where the parts can be built in the controlled atmosphere of a shop. Welding of aluminum must be done by the heliarc process which requires special welding equipment not usually available to most contractors, especially in the field.

Aluminum presents some special challenges to the designer with respect to repeated stress. As Figure 4.15 illustrates, aluminum parts (especially welded members) must be designed against fatigue failure since the material does not show a true endurance limit (Patton, 1976). Electrolysis may also be a problem if a dissimilar metal (such as a

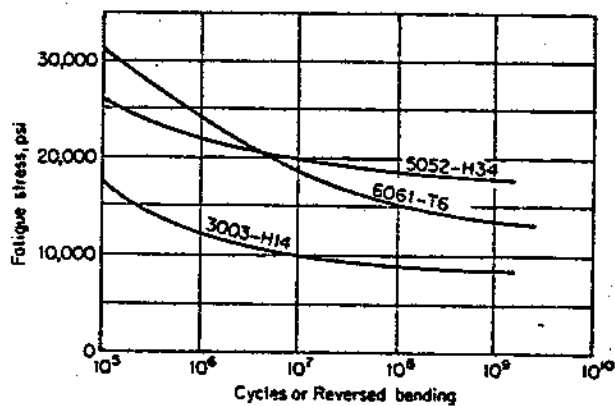

Figure 4.15 Typical Fatigue Curves of Aluminum Alloys (Patton, 1976, p. 267)

boat hull) contacts the aluminum for any length of time. Electrolysis and corrosion are discussed by Hubbell and Kulhawy (1979a).

Pure aluminum is not often seen as a structural material since it is soft and relatively weak (ultimate tensile strength only 1×10^4 psi or 68.9 MN/m^2). On the other hand, in the alloy form strengths, as high as 7.5×10^4 psi (517 MN/m^2) are possible. The most common alloys are the 5000 series (magnesium) for sheet and plate members, and the 6000 series (magnesium-silicon) for extrusions. The properties of a low alloy commercial aluminum (99% pure) are presented in Table 4.7.

4.5 WROUGHT IRON

Wrought iron consists of grains of pure iron interspersed with filaments of iron silicate slag (Chaney, 1961). The grain structure is such that the individual crystals are visible to the naked eye on a fractured surface. While many designers consider wrought iron a material of the past, its excellent resistance to corrosion makes it a viable product even when used in saltwater.

The corrosion resistance of wrought iron is two-fold. First, the protrusion of the silicate threads through the surface enables wrought iron to retain a coating of corrosion that serves to protect the base metal. In the case of steel, this layer of "rust" easily falls off to allow continuing corrosion. Secondly, the rough surface typical of wrought iron members causes them to retain a heavier coating of zinc (if galvanized) or other coating than equivalent steel members, resulting in longer design lives.

Because of its grain structure, wrought iron has directional physical

Table 4.7 Properties of Commercial Aluminum (Cordon, 1979, p. 214)

Alloy and temper [†]	Tension				Hardness	Shear	Fatigue
	Yield strength at 0.2 percent offset, MPa	Ultimate strength, MPa	Elongation in 2 in. percent		Brinell 500-kg. 10-mm ball	Shearing strength, MPa	Endurance limit [‡] , MPa
			Sheet $\frac{1}{8}$ in thick	Round $\frac{1}{2}$ in diameter			
2S-0	34.5	89.7	35	45	23	65.5	34.5
2S-H12	89.7	103.4	12	25	28	69.0	41.4
2S-H14	96.6	117.2	9	20	32	75.9	48.3
2S-H16	117.2	137.9	6	17	38	81.8	58.6
2S-H18	144.8	165.7	5	15	44	89.7	58.6

[†] Temper designation: 0, annealed; H18, fully cold-worked (hard); H12, H14, H16, intermediate degrees of cold work between 0 and H18.

[‡] Based on 500 million cycles, using R. R. Moore type of rotating-beam machine.

characteristics much like wood. During the rolling and forming process, the slag inclusions become oriented in the longitudinal direction or the direction of rolling. The material therefore has greater tensile strength on the longitudinal axis and is more easily bent (more ductile) in the longitudinal direction than the transverse direction. In general, the physical properties of wrought iron are approximately the same as pure iron (Cordon, 1979). Wrought iron typically has a maximum carbon content of 0.35 percent while medium-high carbon steels range from 0.35 to 1.5 percent (Patton, 1976). Primarily because of its ductility, wrought iron is commonly formed into pipes, plates, sheets, bars, angles and channels.

4.6 SUMMARY

The materials used in the construction of coastal structures must be strong and durable. The waterfront is a very harsh environment for man-made structures, and their success is directly a function of the properties of the materials involved.

The primary coastal construction materials are concrete, steel, and wood. Aluminum and wrought iron are used less frequently. The advantages and disadvantages of each of these materials have been discussed.

Concrete properties such as durability, permeability, and abrasion resistance are more critical than strength. A mix designed for the former considerations is usually assured of adequate strength. The water-cement ratio of the paste and the soundness of the aggregate are the most important parameters determining concrete quality. Steel is a very common material used in civil engineering, and its properties

are well known. Steel must be protected from rapid corrosion for it to reach an acceptable design life. As a natural material, wood and its engineering properties can be quite variable. Wood properties depend on species type, and the presence of defects or imperfections. Grading rules have been developed to reduce the clear wood strength properties because of these defects and to determine working strengths to be used in design. Aluminum is gaining acceptance as a coastal construction material because of its light weight and high strength. It is now used primarily as a material in prefabricated dock systems. Wrought iron consists of pure iron with internal filaments of silicate slag. It has very high corrosion resistance and is one of the preferred materials for hardware and fasteners.

CHAPTER 5

SOLID FILL TYPE DOCKS, PIERS AND WHARVES

Docks, piers and wharves constructed of a natural or artificial fill surrounded by a vertical wall are considered solid fill structures. While there are many variations, anchored bulkheads are the most common wall type. Others include cantilever sheet pile walls, cantilever "L" walls, gabion walls, crib walls, cellular sheet pile walls, concrete caisson walls, and walls supported by relieving platforms. Each wall type is suitable for different applications depending on the required depth of water, character of the foundation material, loads imposed, and the allowable movement once it is put in service. Basin depth depends on boat size and berth layout plan, topics that were discussed in Chapter 2. Soil properties and the loads soils impose on a retaining wall are addressed by Saczynski and Kulhawy (1982). Wall structures are also described by Ehrlich and Kulhawy (1982) with regard to their use for erosion control and wave protection.

This chapter presents a brief discussion of each wall type, the factors involved in selecting the proper wall type for a particular site or application, and the design considerations pertaining to the use of solid fill structures for docks, piers and wharves.

5.1 WALL TYPES

Anchored Bulkheads and Cantilever Sheet Pile Walls

Anchored bulkheads consist of a row of interlocked sheet piles, stiffened across the face by wales and restrained from moving away from the fill by tie-rods connected to anchors (Figure 5.1). A cantilever

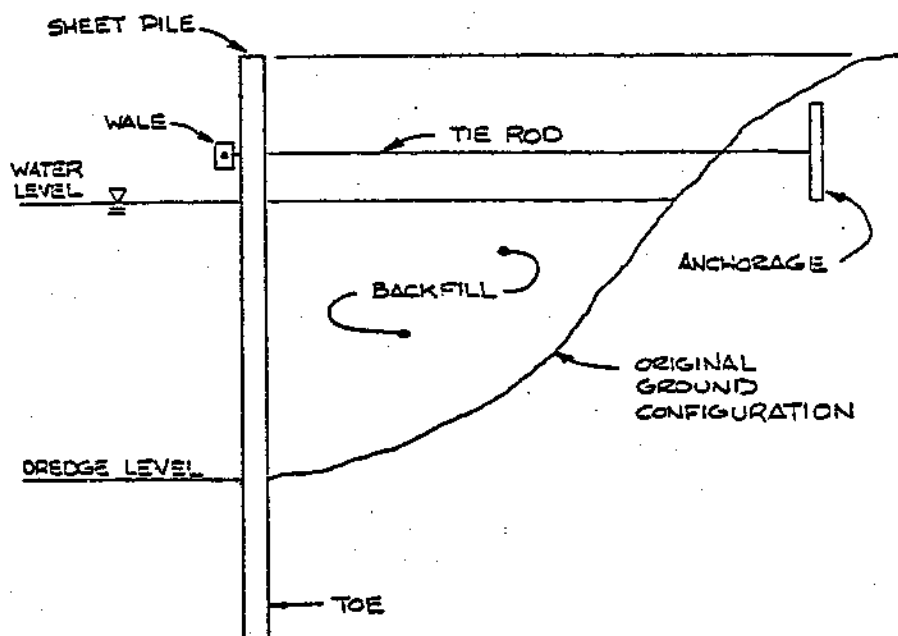

Figure 5.1 Anchored Bulkhead Wall (Saczynski and Kulhawy, 1982, p. 8)

sheet pile wall differs from an anchored bulkhead in that it does not have an anchor system and depends for stability on its embedment and sometimes heavier cross-section (Figure 5.2). The cantilever wall is better suited to relatively shallow water or sites where anchorage is poor (Saczynski and Kulhawy, 1982). Traditionally, anchorage for bulkheads is obtained from deadmen, braced piles, sheet piles or footings located in the back-fill. In the case of relatively narrow solid fill piers, the tie rods extend through the fill to the adjacent bulkhead. This removes the need for an anchor system, but the wall must be analyzed further for stability against tilting as a unit. Anchored bulkheads and cantilever sheet pile walls may be designed as described by Saczynski and Kulhawy (1982).

Cantilever "L" Walls

The cantilever "L" wall consists of a concrete stem and concrete base slab (Figure 5.3). Both the stem and slab are relatively thin and are steel reinforced to resist the moments and shears to which they are subjected (Peck, Hanson, and Thornburn, 1974). Cantilever "L" walls have not found widespread application as bulkheads but are often used in conjunction with relieving platforms (Chaney, 1961). Where the design finds them a viable alternative, these walls may be analyzed and designed using methods described in texts on soil mechanics or foundation engineering. Peck, Hanson, and Thornburn (1974) and Terzaghi and Peck (1967) are useful references for rigid retaining walls.

Gabion Walls

Gabions (Figure 5.4) are low cost structural walls that offer several advantages, including: (1) flexibility, allowing them to adjust to

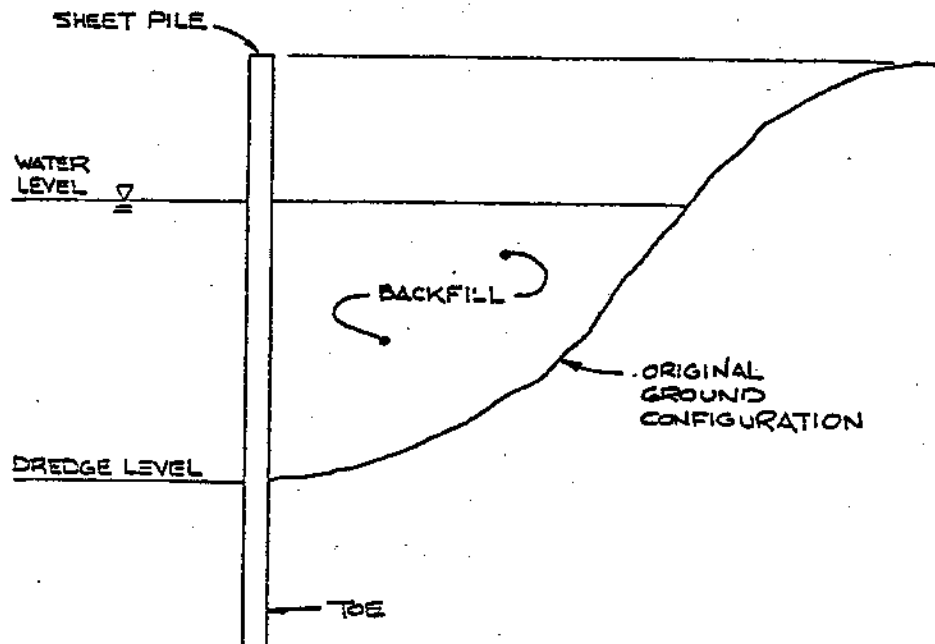

Figure 5.2 Cantilevered Sheet Pile Wall (Saczynski and Kulhawy, 1982, p. 14)

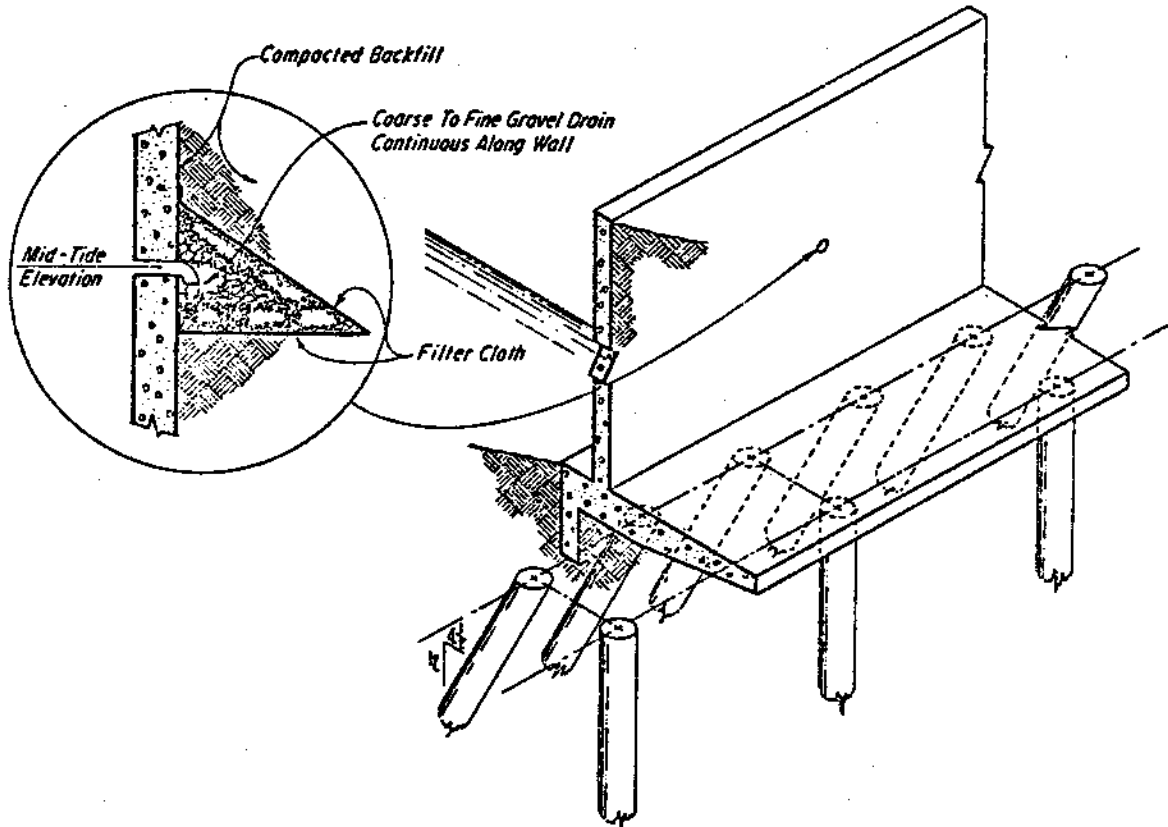

Figure 5.3 Typical Pile Supported "L" Wall for Weak Soils.
(Dunham and Finn, 1974, p. 103)

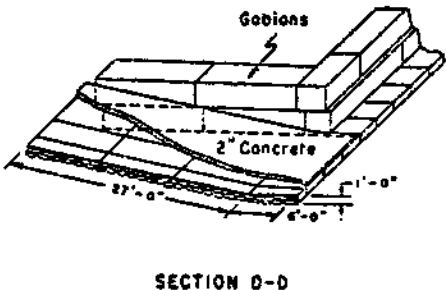
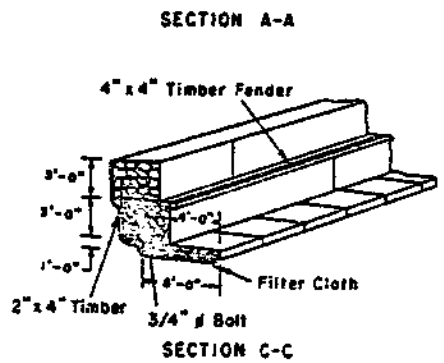
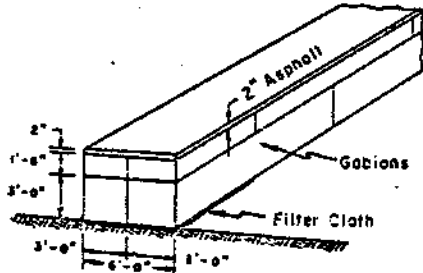
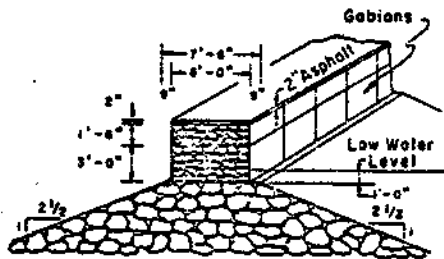
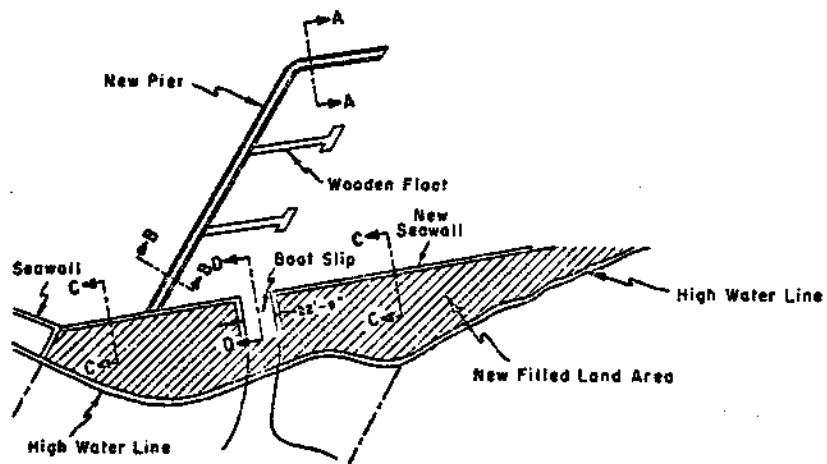

Figure 5.4 Use of Gabions in Marina Construction (Dunham and Finn, 1974, p. 91)

foundation irregularities and settlement, (2) versatility, or the capability to be placed and filled under water with minimal problems, and (3) permeability, preventing the development of a hydrostatic head in the backfill (Hubbell and Kulhawy, 1979a). Gabion assembly is labor intensive and requires the rock fill to be hand placed before the lids are "sewn" shut with wire. Protection in the form of a fender system or facing material is a must for gabion walls since the wire mesh is susceptible to damage by impact which could allow the rock fill to spill out. When used to support a solid fill structure, it is common practice to cap the wall with a concrete slab (Bekaert Gabions, 1977) which may dramatically reduce flexibility. Gabions as a coastal material are discussed by Hubbell and Kulhawy (1979a) while Ehrlich and Kulhawy (1982) address the use of gabions in coastal protection structures.

Crib Walls

Rock filled crib walls constructed of timber (Figure 5.5) or precast concrete elements act in much the same manner as gabions. They can withstand considerable racking and settlement without rupture, and are permeable enough to relieve excess hydrostatic stress in the backfill. According to Quinn (1972), rock-filled timber cribs were used extensively on the Great Lakes for early construction of piers and wharves. When timbers are used for the cribbing, the wall is usually terminated at low water level and the wall above is constructed of concrete. In this manner, the wood remains saturated and is less susceptible to borers and natural deterioration. Standard designs for pressure-treated timber cribs have been suggested by the American Wood Preservers Institute (1969).

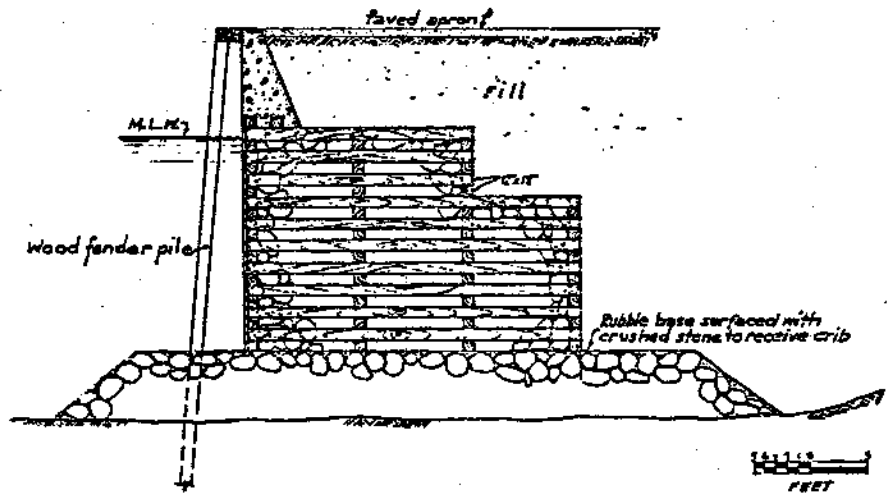

Figure 5.5 Typical Timber-Crib Wharf
(Quinn, 1972, p. 279)

Cellular Sheet Pile Walls

One variation of the conventional steel sheet pile wall is the cellular wall type illustrated in Figure 5.6. The cellular sheet pile wall possesses a high degree of stability in conditions where anchored bulkheads are impractical. It should be considered for dock, pier and wharf construction where the water depth is greater than the feasible anchored bulkhead height, or where sufficient penetration may not be obtained because of shallow bedrock (Cummings, 1957). To avoid stability problems or excessive settlement when used on soft materials, predredging and placement of a foundation mat may be necessary. A stability analysis for cellular sheet pile walls should include sliding along the base, overturning as a unit, and rupture of the web and interlocks (USCOE, 1963). Circular cells connected by intermediate arcs are used more often than the diaphragm type wall (Figure 5.7) since each individual cell may be filled independently of the others and is stable in itself (Quinn, 1972). Cummings (1957) notes that the main cells of a circular cellular wall increase in diameter about 1.5 percent when the pressure of the fill takes up the slack in the sheet pile interlocks. The connecting arcs may then bulge outward beyond the bulkhead line causing construction problems with the deck and fender system. Locating the connecting arcs such that their tangent is about 2 ft. (0.6 m) back from the deck line is a solution recommended by Cummings (1957).

Concrete Caisson Walls

A caisson wall is composed of a row of reinforced concrete shells that are floated into position, sunk, and filled with a granular material. Figure 5.8 illustrates a closed bottom caisson resting on a prepared,

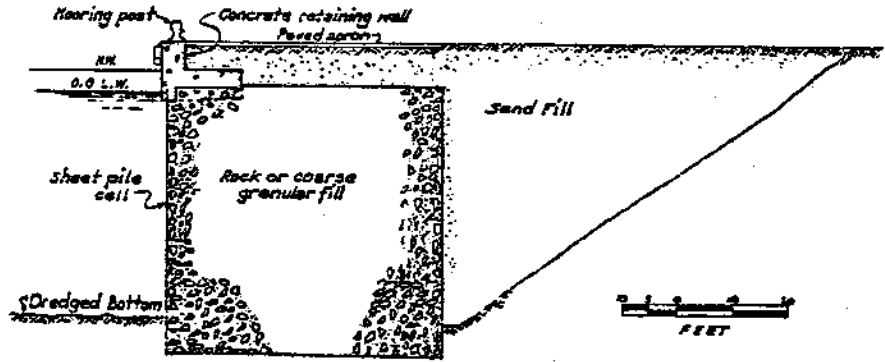

Figure 5.6 Cellular Sheet Pile Wharf
(Quinn, 1972, p. 277)

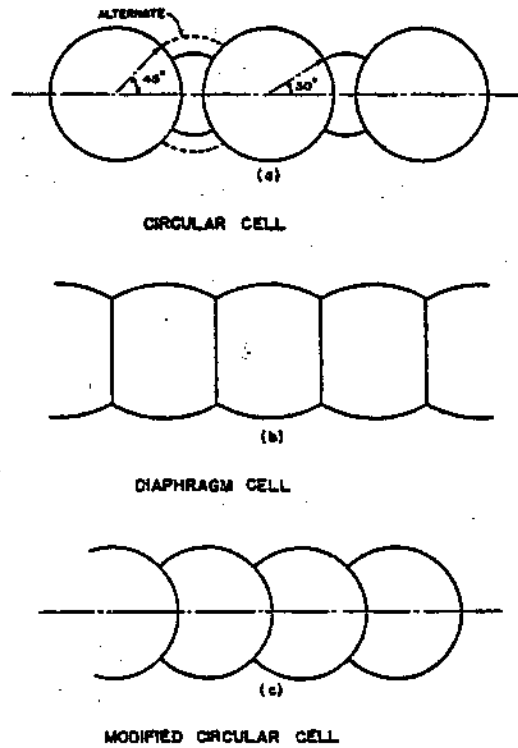

Figure 5.7 Sheet Pile Arrangement for Cellular Walls
(Cummings, 1957, p. 1366-2)

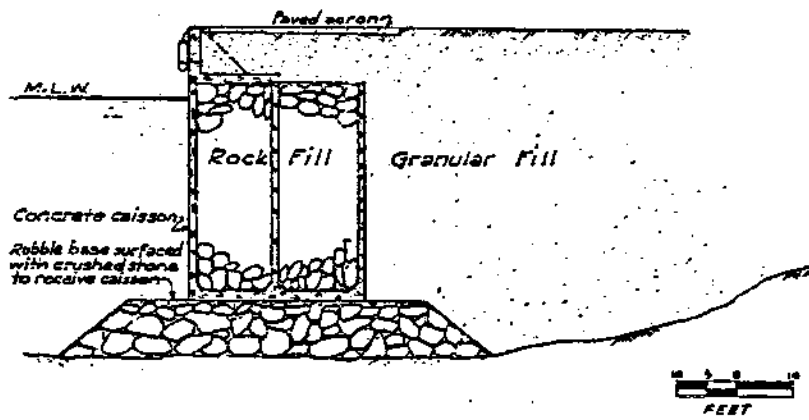

Figure 5.8 Concrete Caisson Wharf
(Quinn, 1972, p. 280)

level foundation mat. Open well caissons with cutting edges that obtain support by sinking into a soft bottom are also used (Quinn, 1972). Caissons are usually designed so that their tops lie just above the low-water level. A cast-in-place concrete cap forms the upper part of the dock face, allowing true alignment and grade as well as providing for the attachment of the fender system, cleats, railings, and other hardware. One of the advantages of concrete caissons is that much of the construction work is performed on land for ease of access. In addition, construction is much less dependent on weather and wave conditions.

Relieving Platforms

A relieving platform type bulkhead combines many of the features of walls previously discussed into one system. As Figure 5.9 illustrates, it consists of a concrete wall resting on a pile supported timber platform. A line of sheet piling retains the soil behind the bulkhead while rip-rap under the platform provides stability. The relieving platform is suitable for greater water depths and softer underlying material than are sheet pile walls (Chaney, 1961). To minimize deterioration and prolong its life, the timber members of the relieving platform should be located at or near the low-water level so that they are continuously wet. The rip-rap acts to reduce the stresses in the sheet pile wall while at the same time protecting against loss-of-ground from scour. In addition, its sloped and porous surface absorbs wave energy and creates a calmer berthing environment. Depending on the geometry of the face of the platform, problems can arise because of air pressure that causes

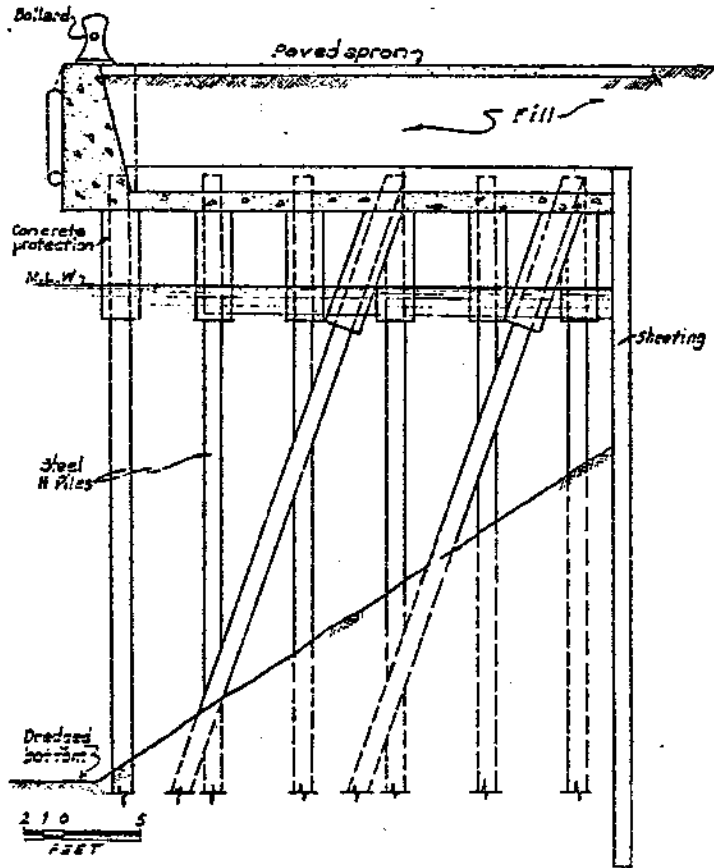

Figure 5.9 Relieving Platform Type Wharf
(Quinn, 1972, p. 270)

structural damage and rip-rap instability (Leitass, 1979). Figure 5.10 illustrates the effect of wave characteristics on this air pressure buildup, while Figure 5.11 shows the reduction of air pressure in relation to relief hole area. Remedial measures include reducing the wave energy with protective structures, resisting the air pressure by stronger platform design, and arranging for air relief. While relieving platforms are the most desirable wall type with respect to permanence and stability, they are also the most costly to construct (Chaney, 1961).

5.2 SELECTION OF WALL TYPE

Each of the wall types discussed above has been constructed and has performed effectively in harbors around the world. None of the wall types are universally applicable to any given location, however. In addition to sound design, construction and maintenance practices, a successful installation requires that the wall be well-suited to the site conditions and its intended application. The designer should consider the following factors when selecting a wall type to be used at a particular location (after Chaney, 1961):

1. Water depth. The basin depth at the face of the bulkhead in most marinas ranges from 8 to 12 ft (2.5 to 3.5 m) (See Chapter 2). For this wall height, anchored bulkheads will be the most economical wall type, given sufficient embedment and anchorage for stability.
2. Soft Substrata. When the substrata is composed of layers of soft sediments, piles driven to "refusal" will show less settlement than gravity structures such as crib walls or concrete caissons.

AIR PRESSURE INCREASES AS WATER LEVEL RISES REACHING MAX. VALUE AT SOME ELEVATION ABOVE L.W.L. AFTER WHICH IT GRADUALLY DECREASES UNTIL THE HIGH W.L. IS REACHED.



a) INFLUENCE OF WATER LEVEL

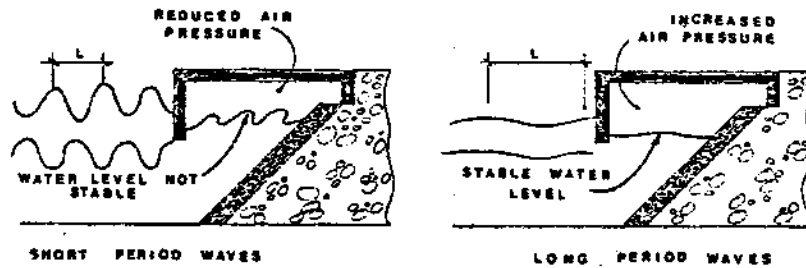

b) INFLUENCE OF WAVE PERIOD

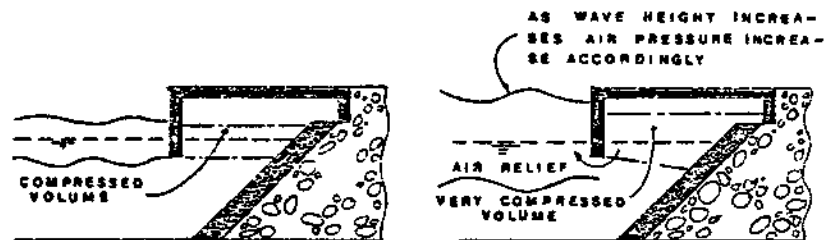

c) INFLUENCE OF WAVE HEIGHT

Figure 5.10 Effect of Wave Characteristics on Air Pressure Buildup (Leitass, 1979, p. 1120)

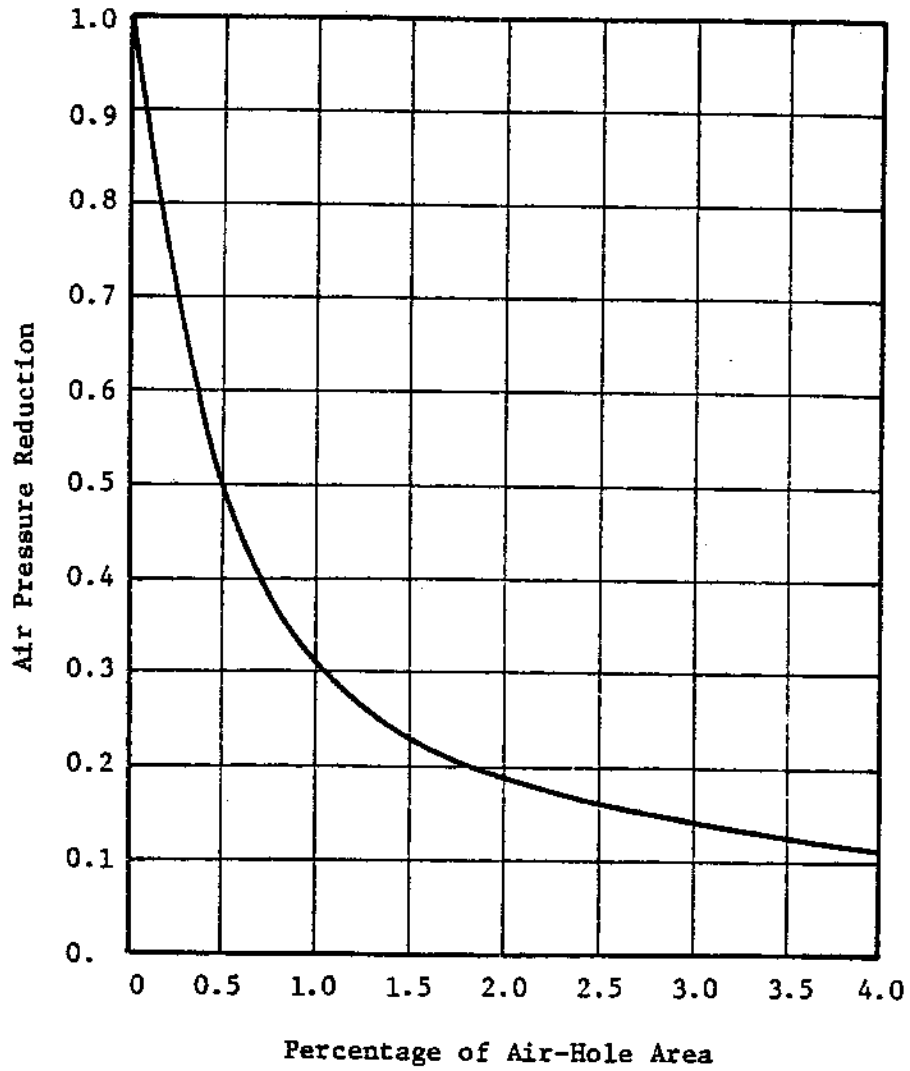

Figure 5.11 Reduction of Air Pressure in Relation to Percentage of Air-Hole Area (Leitass, 1979, p. 1122)

3. Hard Substrata. When a dense layer of soil or rock lies at a shallow depth below the dredging line, piles may not penetrate far enough for adequate horizontal stability, and concrete caissons or filled cribs may be more suitable.
4. Settlement. The use of gravity walls (rock filled cribs and concrete caissons) causes high contact stresses on the foundation. When placed on relatively soft underlying materials, these walls are subject to settlement and horizontal slippage that may result in damage to walks, buildings, and other structures resting on them.
5. Predredging. In extreme cases, it may be necessary to dredge soft foundation materials and replace them with a bedding layer of sand and gravel. This technique will reduce settlements in gravity walls, and assure adequate anchorage for sheet pile stability. Densification of bottom materials may also be achieved by loading with a layer of rip-rap.
6. Berthing Access. The use of a relieving platform with a line of sheet piles driven landward of the platform, or sheet piling alone, driven at the face of the bulkhead will permit dredging to full project depth up to the face of the wall. On the other hand, sloping rip-rap and some crib walls will encroach considerably into the water area and prevent boats from berthing along the wall.
7. Materials. The durability and disintegration of materials when subjected to alternate wetting and drying should be

considered when selecting a wall type. For material properties see Chapter 4. Materials are also discussed by Hubbell and Kulhawy (1979a).

5.3 GEOTECHNICAL DESIGN CONSIDERATIONS

Perimeter walls in small craft harbors are seldom used as breasting docks permitting boats to tie up parallel to the wall face (Dunham, 1969). Except for small scale projects or private installations, breasting is an inefficient use of dock space. Bow clamps and stern hooks have been used to moor small craft perpendicular to a perimeter wall, but they are inconvenient to use and pose boarding problems.

Generally, solid fill structures are used to stabilize the boundary walls of a harbor and provide anchorage and access to either a fixed or floating berthing system. In some locations, fire and safety regulations require that the fuel dock be of solid fill construction (See Chapter 8 on Utilities and Services). Where solid fill docks, piers and wharves are to be used, some areas of design deserve special attention. The following discussion addresses foundation design, dredging, and back-fill considerations for solid fill walls.

Foundation Design Considerations

Foundation design is concerned with the interaction between a structure and the material it rests upon. In the case of waterfront structures such as docks, piers, and wharves, the underlying material usually consists of layers of sand and clay. The in-place or undisturbed density of these marine sediments is often quite low since they are deposited under water in a very loose condition. Although the engineering behavior

of clay in general is very complex, it should be sufficient for this discussion to note that marine clays are often weak and highly compressible. Sands, on the other hand, are much less compressible and can be easily densified through vibration. In practice, soils range continuously from fine-grained (clay) to coarse-grained (sand) sizes. Since the engineering properties of a soil are highly dependent on grain size and in-situ condition, a geotechnical investigation is usually performed to characterize the soil type, extent, and expected behavior. The scope of such an investigation depends primarily on the scale of the project and the discretion of the designer.

The character of the underlying soil is an important factor influencing the stability and settlement of a foundation. In addition, scour potential is determined by the soil type to be transported as well as the energy available to move it. Ideally, foundation design is intended to protect structures from failure because of a lack of bearing capacity, excessive settlement, rapid scour, or combinations of these. Unfortunately, foundation design is often minimized in coastal structure design, resulting in problems that are difficult and costly to repair. The following discussion briefly addresses each of the possible failure modes with respect to waterfront design. It is not within the scope of this report to go into the details of geotechnical analysis; the reader should refer to texts on soil mechanics and foundation engineering for this information.

Bearing Capacity. Bearing capacity refers to the ability of the foundation to carry a load without failure within the soil. Failure

usually occurs because of shearing of the underlying strata and backfill along a curved surface (Figure 5.12). Stability of a sheet pile wall depends on the depth of embedment; greater embedment depth forces the failure surface to go deeper and thereby mobilizes more resistance. Saczynski and Kulhawy (1982) present the procedures for analysis and design of anchored bulkheads and cantilever sheet pile walls. The stability of gravity walls such as concrete caissons, cribs and gabions is dependent on the size of the base and the wall weight, and may be enhanced by the placement of bedding layers.

According to Quinn (1972), the bedding layer should extend beyond the toe and the critical plane of failure so that its weight and strength increase the factor of safety with respect to a shear failure at the toe (Figure 5.13). A properly designed bedding layer will reduce settlement by spreading out the wall load to decrease its contact pressure below, provide a leveling course that facilitates construction, and protect the foundation material against scour. Foundation blanket design is addressed by Ehrlich and Kulhawy (1982).

Stability against a bearing capacity failure can only be determined through a detailed geotechnical analysis. The approach commonly used is to analyze a number of possible failure planes and determine which is likely to be critical. The conservative assumptions of a fully saturated backfill and extreme low water at the face of the wall are made to simulate the worst expected service condition. A more critical state can be created during construction if poorly administered hydraulic fills are used in conjunction with dredging in front of the wall. According to the Committee for Waterfront Structures (1966), a temporary lateral pressure may exist with an

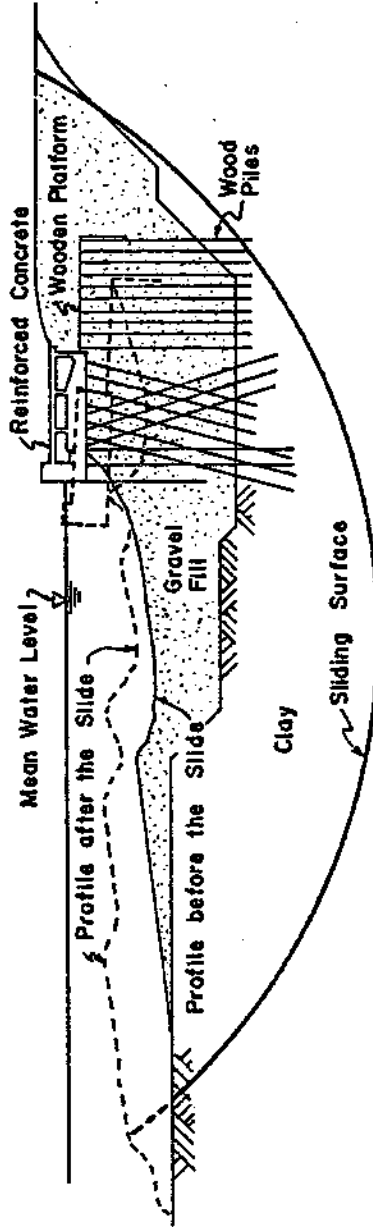

Figure 5.12 Deep-seated Failure of a Retaining Platform Because of Insufficient Bearing Capacity of Underlying Weak Soil (Dunn, Anderson, and Kiefer, 1980, p. 237)

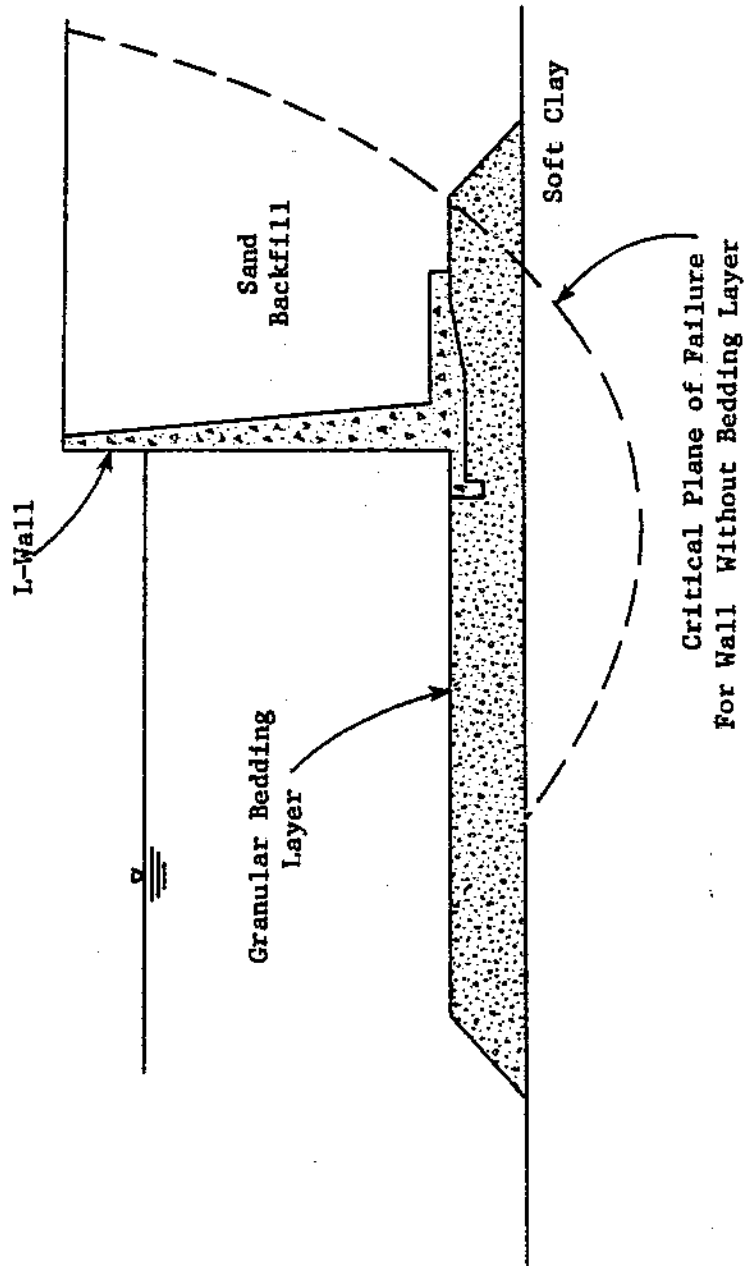

Figure 5.13 Granular Bedding Layer Used to Increase the Bearing Capacity of an Underlying Weak Soil

intensity somewhere near the hydrostatic pressure of a material with the density of the slurry and the earth pressure at rest of the consolidated hydraulically filled soil. The actual pressure will depend on the degree of consolidation the fill has reached.

Settlement. Settlement relates to the downward movement of a structure during and after construction. The two major causes of settlement of waterfront structures are the consolidation of weak, compressible soils in the foundation and the removal of supporting soil from scour. Scour related settlement is discussed in a subsequent section.

Settlement is not always detrimental to solid fill docks, piers and wharves. Uniform settlement can be tolerated as long as the wall remains functional and buried utilities are not damaged. On the other hand, differential settlement from compressible strata of irregular thickness can easily result in structural damage to the wall that will lead to complete failure. Some wall types, notably gabion and timber crib walls, are more resistant to differential settlement and racking than are rigid walls. While a deformed wall may be structurally sound, its appearance can deter users such that it constitutes a functional failure. Although good foundation design cannot eliminate settlement, its magnitude may be reduced and its effects mitigated so that it is no longer harmful to the structure.

Consolidation settlement is a time-dependent phenomenon that occurs when a surcharge load is placed above a layer of soft substrata. One method of controlling this settlement is to place a temporary surcharge to "preconsolidate" the soil. After consolidation is complete, the surcharge is removed and is replaced by a wall structure and backfill. A

disadvantage of preconsolidation is that substantial time (measured perhaps in years) is necessary for completion, especially if the foundation materials are fine-grained with low permeability. An alternative suggested by Quinn (1972) is excavation and replacement of the compressible layer with a more competent material. Foundation mats are commonly used beneath gravity walls to provide a stable base for construction and minimize settlement. Design of these mats is presented by Ehrlich and Kulhawy (1982).

Scour. Bulkheads must be both vertical and smooth-faced to serve properly as a dock, pier or wharf. Unfortunately, such a barrier is a very efficient reflection of wave energy and is accepted as the primary cause of bed scour. Since scour potential is greatest at the toe of a wall where its smooth face meets the foundation material, progressive excavation will take place until undermining, stability and settlement problems occur. The situation may be aggravated if excess hydrostatic pressures are allowed to build up in the backfill as in the case of hydraulic fill placement. Water will then flow along a path leading under the toe of the wall and cause a reduction in the soil strength and resistance to erosion.

When scour-induced erosion is expected to be a problem, protection is commonly provided in the form of a foundation blanket. While the blanket serves as a mat to distribute wall loads over a larger area and reduce settlement and bearing capacity problems, it must also be designed as a filter to avoid the loss of fines through its voids. The mechanism

of scour and protective measures including foundation blanket design are addressed by Ehrlich and Kulhawy (1982). Additional references that should be consulted include Hale (1980) on site-specific scour problems, scour control methods and construction techniques, and Keown and Dardeau (1980) on filter fabrics and filter design criteria.

Dredging

While the general topic of dredging is presented later in this report (See Chapter 9), some of the aspects of dredging that relate to solid fill structures should be mentioned here. The dredging process occurs in two phases. The first or initial phase is performed when the harbor basin is originally excavated for navigation. Dredging must precede placement of a foundation mat for gravity type walls. In the case of sheet pile walls, however, Saczynski and Kulhawy (1982) recommend that dredging operations be conducted after wall construction is complete and the backfill has been placed and consolidated. This delay allows arching to occur in the backfill that will reduce the stress level in the wall and result in less outward deflection.

The second or maintenance phase of dredging must be carefully administered to avoid over-dredging and hitting the wall. Over-dredging adjacent to the wall should not be allowed since excavation of material below the original design depth will result in a loss of toe support and possible stability problems. Depending on the dredge method used, it is relatively easy to damage bulkheads structurally by hitting them. The dredge operator must exercise caution and proceed more slowly than usual.

Another important aspect of dredging is the disposal of the excavated

material. Assuming the soil is acceptable backfill material, using it for fill behind the wall is obviously more efficient than wasting it away from the site. The use of dredge spoil for backfill is discussed subsequently while other disposal methods are addressed in Chapter 9.

Backfill

The second step in solid fill dock, pier or wharf construction following the completion of the wall is the placement of the backfill. The type of fill material and method of placement used are important parameters determining wall stability and long-term performance. These topics are addressed in the following discussions.

The strength and engineering behavior of cohesive soils or clays is highly variable and depends on mineralogy, structure, stress history and water content. Low permeability and poor drainage is characteristic of clay fills causing them to consolidate for long periods of time, and to develop hydrostatic imbalances under the action of heavy rain or rapid tides. A successful clay backfill requires that the same type of soil be used throughout and that special attention be given to the water content and compactive effort during placement so that a uniform solid mass is achieved. The Committee for Waterfront Structures (1966) suggests, however, that compaction of clay backfills causes considerable additional earth pressure that may damage an otherwise sound wall. In light of these problems, cohesive backfills should be used only when cohesionless materials are not available within a reasonable radius of transportation.

Saczynski and Kulhawy (1982) suggest that a coarse-grained, free-draining backfill should be used whenever possible. Because the engineering behavior of these cohesionless materials (sands and gravels) is

predictable, the resulting wall designs are quite reliable. Bray (1979) recommends that specifications for sand fills should include the following: (1) required grain size distribution - to ensure that the soil can be compacted to a suitable density, (2) minimum acceptable particle size and the percentage of this size which is allowable - to control settlement and to be used in filter design, and (3) acceptable organic content - since the presence of organics affects settlement and soil strength. Compaction specifications should also be written to address in-situ densities and compaction techniques.

Relative density is a qualitative parameter used to measure the degree of compaction of granular soils. In its most convenient form, the relative density, D_r , is defined as follows:

$$D_r = \frac{\gamma_m (\gamma - \gamma_o)}{\gamma (\gamma_m - \gamma_o)}$$

where γ_o = minimum density of soil in laboratory

γ = field density of soil

γ_m = maximum density of soil when compacted in laboratory by vibration

The relative density of a soil is usually expressed as a percentage and may vary from 0 percent to 100 percent. A relative density of 0 percent represents the loosest state theoretically possible while a soil at 100 percent relative density is in its most dense condition. While shear strength in a sandy soil also depends on particle size and shape, greater densities result in increased strength and bearing capacity.

Fills derived from sand containing less than 15 percent fines can be placed naturally to a medium relative density (44 to 55 percent) capable of supporting foundation pressures of 500 - 3000 psf (24-144 kN/m^2) (Bray, 1979). The Committee for Waterfront Structures (1966)

notes that a relative density of around 85 percent may be obtained by placing the fill in well-compacted layers.

Placement of backfill material is accomplished by either mechanical or hydraulic means. Mechanical methods include dumping by truck, or dropping from a clamshell, dipper, or drag bucket. The fill is first placed in piles and then distributed into even layers with a bulldozer. Hydraulic fills are created by pumping a soil/water mixture into a contaminant area through a pipeline. Hydraulic fills are very convenient when granular materials must be dredged nearby, but they create some special problems. Ponding of the water in the reclamation area should not be allowed since fines may be segregated into mud pockets. Unfortunately, the initial fill behind a bulkhead must often be placed underwater. Bray (1979) suggests that this initial layer be formed to a level 2 to 3.5 ft. (0.5 to 1 m) above the maximum level of the water in front of the wall. Subsequent layers 3.5 ft. (1 m) thick can be added as compaction and consolidation is achieved. Saczynski and Kulhawy (1982) note that the fill should be placed in even lifts along the length of the wall to avoid local overstressing.

Compaction of sandy fills is commonly achieved through the use of vibroflotation or a vibratory roller. Vibratory compaction is effective only in well-drained soils and becomes less efficient with increasing silt or clay content. Vibroflotation can be conducted above or below the water table and is accomplished by inserting a vibrating probe into the fill and feeding the annular space around the probe with additional fill material as it is withdrawn (Bray, 1979). A grid spacing of less than 15 ft. (5 m) is normally required to obtain full coverage or 80

percent relative density using a 100 horsepower probe. Vibratory rollers are used above the water table where the density that may be achieved depends on the soils moisture content. Bray (1979) suggests that a vibratory frequency of 1500 to 1700 Hz is most effective in compacting sands.

In areas of active seismicity or intense industrial or construction activity, sand backfills are subject to liquefaction. The vibration of an earthquake, blasting, or heavy equipment acts in much the same manner as vibratory compaction but on a much larger scale. The effect is known as liquefaction and is manifested in a sudden, temporary loss of shear strength. Liquefaction potential depends on soil grain size and density and is greatest for silts and fine sands of uniform gradation. The risk of liquefaction is minimized by specifying a well-graded granular backfill to be compacted as dense as possible.

5.4 SUMMARY

Solid fill structures are rarely used for berthing because of their inefficient use of space and high cost compared to fixed or floating docks or piers. They are more suitable for stabilization and protection of the harbor perimeter and for the construction of marginal wharves.

Selection of the type of solid fill wall depends on site specific conditions and the scope of the project. Anchored bulkheads are the most common wall type for recreational marinas because of their low cost and ease of construction.

Solid fill walls must be designed against bearing capacity failures, excessive settlement, undermining from scour, or combinations of these. Design itself follows the procedures of soil mechanics and foundation

engineering and should be performed by a competent geotechnical engineer. Attention must be given to dredging and backfill operations to control the forces acting on a wall and to avoid damage during construction.

CHAPTER 6

FIXED DOCKS, PIERS AND WHARVES

For the purposes of this report, docks, piers and wharves that are pile supported will be considered fixed structures. Fixed docks and piers are generally less expensive to construct than equivalent floating berths. In spite of their economic advantage, however, there has been a trend away from the fixed structure toward the use of floating slips for all small craft marinas (Dunham, 1969). Fixed berths are usually limited to locations where water surface fluctuations do not exceed 4 ft (1.2 m) and the basin depth is less than about 20 ft (6.0 m). Where greater water surface changes occur, boats are difficult to board at extreme low water, and traveling irons must be provided for safe mooring at all levels. Deep water installations (in excess of 20 ft or 6.0 m) are not economically feasible since piles represent a major portion of the cost of a fixed pier structure, and their cost is directly proportional to the length required.

Fixed pier construction is particularly favorable for covered berthing since long piles can be used to support both the deck and roof. While covered slips provide excellent protection from the elements, they have several disadvantages (Dodds, 1971). The cost of constructing and maintaining the roof must be borne by increased slip rental fees. Since wood is the material commonly used for such structures, fire hazards are dramatically increased while the enclosure makes it difficult to fight the fires. Changing the slip sizes of an open slip system is difficult, but the problem is compounded by a covering which interferes with the equipment needed to pull and drive piles. The economics and

feasibility of the covered berth depend on the analysis of the individual marina site, the intended user, and any future plans for expansion. For small craft up to 30 ft (9 m) in length, dry stack storage as shown in Figure 6.1 should be considered an attractive alternative (New York Sea Grant, 1978). Where covered berths are to be built, standard pole-shed construction is recommended as presented by Patterson (1969). Covered berthing will not be addressed further in this report except to note that failure to design properly for wind uplift forces has been the major cause of damage in these structures (Dodds, 1971).

Fixed docks in general are subject to damage by ice in northern areas. Lateral forces because of expansion/contraction of the ice sheet, as well as vertical forces resulting from water level changes, literally tear a structure apart (Wortley, 1981). Bearing piles are abraded at the waterline and "jacked" out of the bottom. Bracing members are knocked off by ice floe impact, while utility lines are bent or broken by protruding ice rubble. Design of harbor structures for such conditions may be one of two types: with or without ice suppression. Design with ice suppression relies on the operation of a bubbler or propeller system to reduce the ice sheet thickness and the resulting forces. Compressed air bubbles (Figures 6.2 and 6.3) circulate warm water from the harbor bottom by entraining water into the rising bubble plume. Propeller systems operate in the same manner but are more suitable to warmer water of 33 to 36°F (0.5° to 2.0°C). Harbor structures designed without ice suppression must resist the full forces of the ice mass which may approach its crushing strength of about 400 psi (2.8 MN/m^2). Design of dock, pier, and wharf structures for northern small craft harbors is addressed

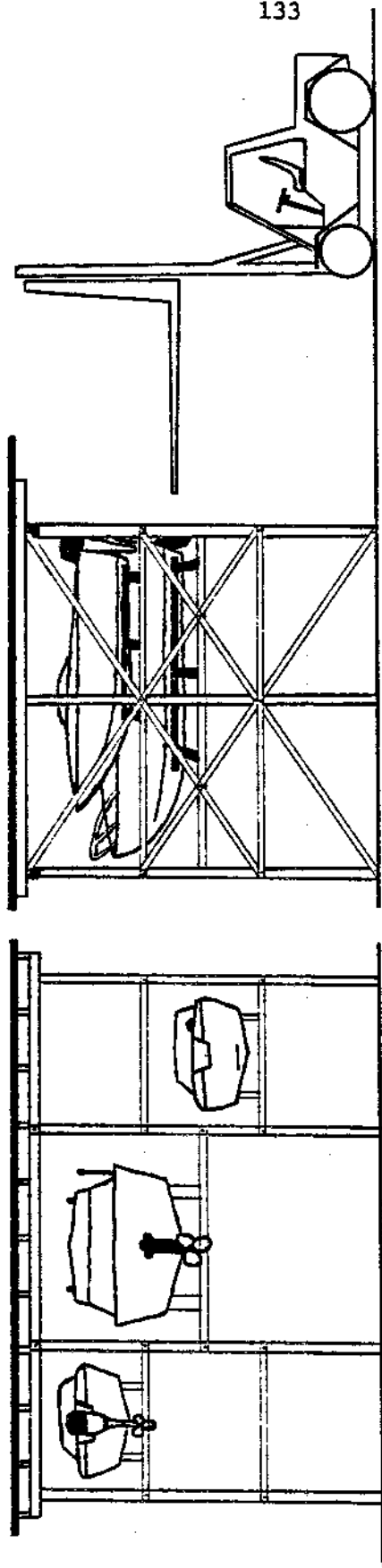

Forklift

B. Side View

A. Front View

Figure 6.1 Dry-Stack Storage

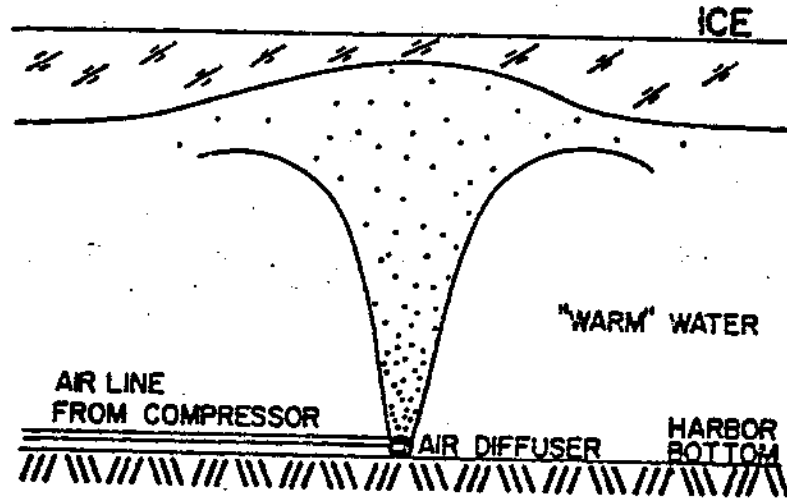

Figure 6.2 Compressed Air-Ice Suppression System (Wortley, 1979, p. 5)

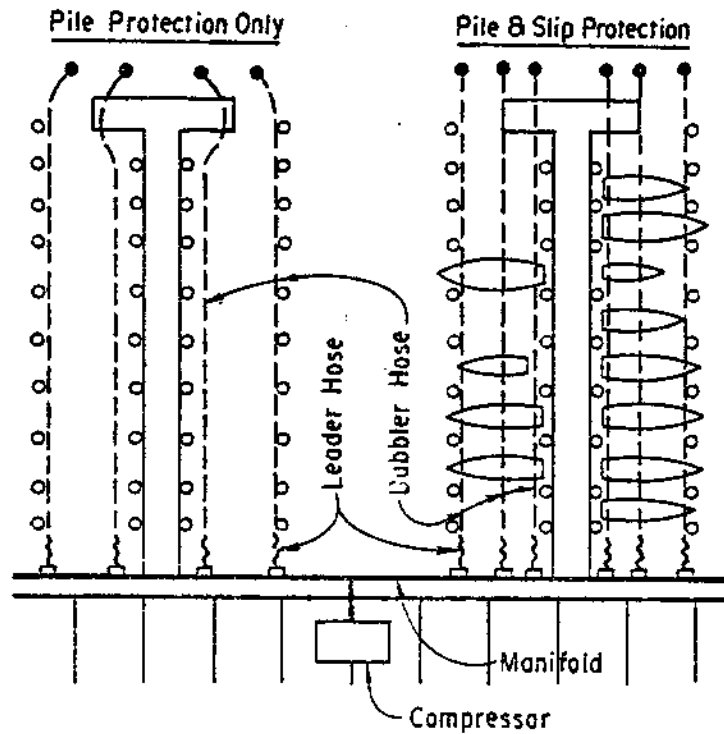

Figure 6.3 Air Bubbler Layout (Dunham and Finn, 1974, p. 216)

by Wortley (1978, 1981). Air bubbler system design for ice suppression is presented by Ashton (1974).

Several manufacturers have developed modular fixed dock and pier systems which offer the marina designer several advantages over a system specifically designed for one location. Design costs are absorbed by the manufacturer and spread out over several installations, thus reducing the total cost per unit. From experience gained by the building of similar structures, many construction problems can be eliminated and necessary design modifications made. Prefabricated systems also lend themselves to rapid installation and ease of expansion. On the other hand, Dunham (1969) notes that most steel and aluminum prefabricated docks have had problems with corrosion in salt water, while Dunham and Finn (1974) state that they are more suitable for individual docks than for large installations as required in marinas. Since these limitations must be considered minor for such a rapidly evolving industry, the marina designer should consider modular dock and pier systems a viable solution to marina berthing design.

The following discussion addresses the design considerations of the components of a fixed dock, pier, or wharf. These topics include structural geometry, pile types by material of construction, design of pile foundations, and decking and framing details. Mooring provisions and fenders as they relate to fixed docks and piers are also addressed briefly.

6.1 STRUCTURAL GEOMETRY

The structural geometry of fixed docks, piers and wharves is relatively simple, as illustrated in Figures 6.4 and 6.5. Piles are arranged

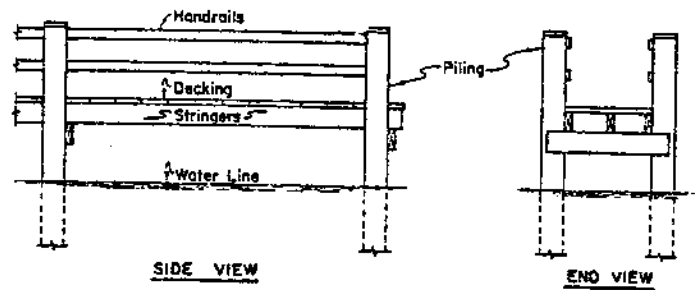

(a) TIMBER CONSTRUCTION

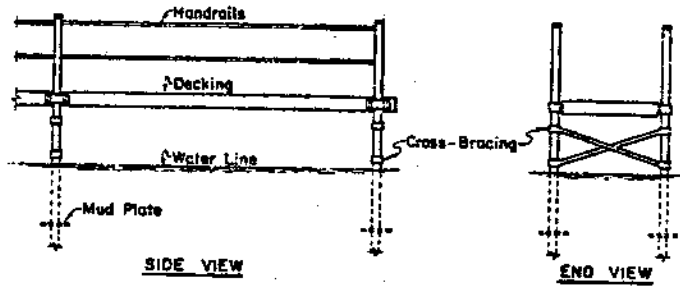

(b) ALUMINUM CONSTRUCTION

Figure 6.4 Fixed Pier Construction (Dunham, 1969, p. 97)

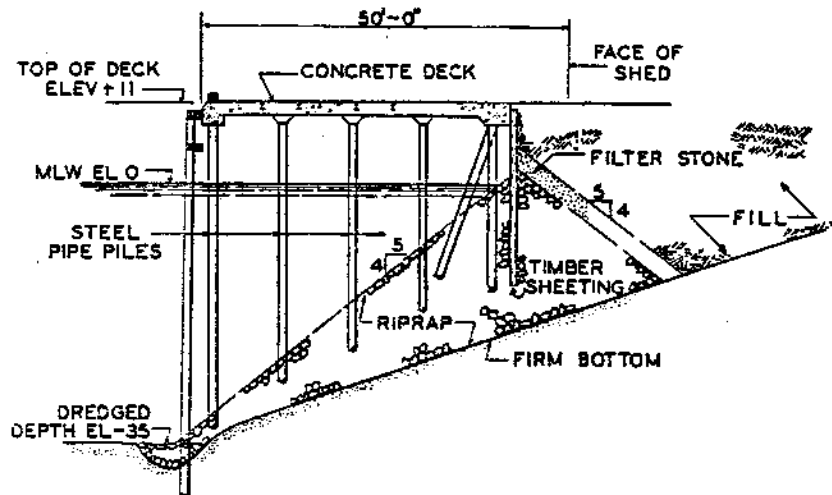

Figure 6.5 High-level Fixed Wharf Construction (AAPA, 1964, p. 38)

in rows or "bents" spaced 10 to 14 ft. (3 to 4 m) apart. A pile cap connecting all the piles in a bent runs from one side of the pier to the other and supports the stringers and deck. Lateral cross-bracing is used to resist lateral loads and provides stability and a sense of rigidity. Where lateral loads are large, inclined or batter piles are used instead. The fixed wharf closely resembles a solid fill relieving platform as described in the previous chapter. The fundamental difference lies in the fact that the fill of a relieving platform extends over the deck to provide additional weight for stability. Fixed wharves typically have high level decks in which the deck superstructure system is supported directly on piles arranged in transverse rows. A lighter deck is therefore acceptable and fewer piles are required since the vertical loads are greatly reduced. Open type fixed wharves are less expensive and easier to construct than are relieving platform wharves.

Fixed docks and piers are smaller (See Chapter 2) and therefore less substantial than fixed wharves. Their structural geometry is the same, however, with pile bents, caps, and stringers supporting a continuous deck. Since fixed docks and piers are built for the purpose of berthing boats, they are generally constructed with a deck elevation 1 ft. (0.3 m) above extreme high water. Sloping gangways connect the low level decks of the berthing system with the perimeter wharf or bulkhead wall.

6.2 PILE FOUNDATIONS

The basic material types for piles used in waterfront construction are timber, steel, and concrete (Figure 6.6). Composite piles formed by combinations of these materials are also used for special conditions. There are two general classes of piles including bearing piles and sheet

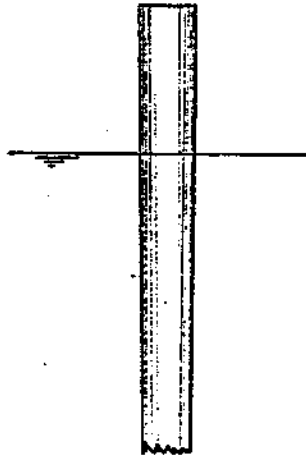

TIMBER PILE

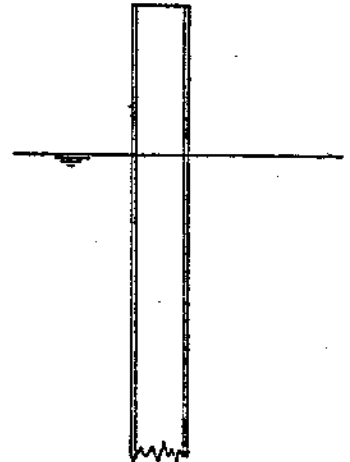

STEEL H-PILE

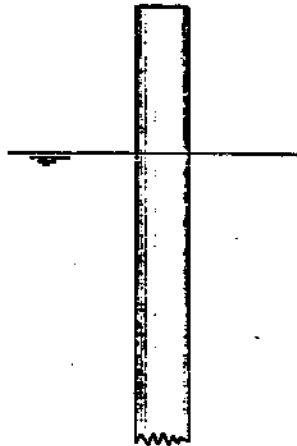

STEEL PIPE PILE, CONCRETE FILLED

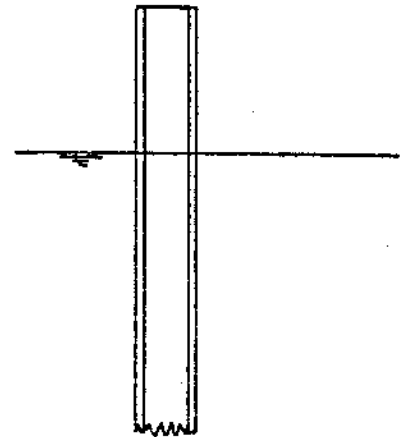

CONCRETE PILE

Figure 6.6 Typical Pile Types Used in Waterfront Construction
(Tobiasson, 1979, p. 2)

piles. Bearing piles are used to support structural loads (both lateral and vertical) while sheet piles form continuous walls to resist horizontal soil and water pressures. Bearing piles may be further classified as "end-bearing" or "frictional" piles. End-bearing piles rely on point bearing on a firm stratum to support the pile load. Frictional piles transfer the applied load into the surrounding soil along the pile embedded length (Figure 6.7). The following section focuses on the bearing pile types by material of construction, the selection of the proper pile type for a given location, the design of pile foundations, and the installation of piles. Pile foundations are also addressed by Cheung and Kulhawy (1981).

Timber Piles

Timber piles are probably the most commonly used pile type on the waterfront because of their availability, constructability, and low cost. According to Tobiasson (1979), timber piles often cost less per foot when in place than other pile types. For many applications, however, their use is limited by their load carrying capacity, length availability, and susceptibility to deterioration. In addition to soil conditions at the point of installation, the capacity of a timber pile is determined by its axial strength which is a function of the material defects inherent in a wood member. Wood defects and strength properties are discussed in Chapter 4. Timber piles are best used as friction piles in soft soils because of their relatively small cross-sectional area and tapered shape. Where they are intended to be used in end-bearing, hard driving through highly resistant soils may cause crushing and damage that is mistaken for additional penetration. The result of over-driving is a structural

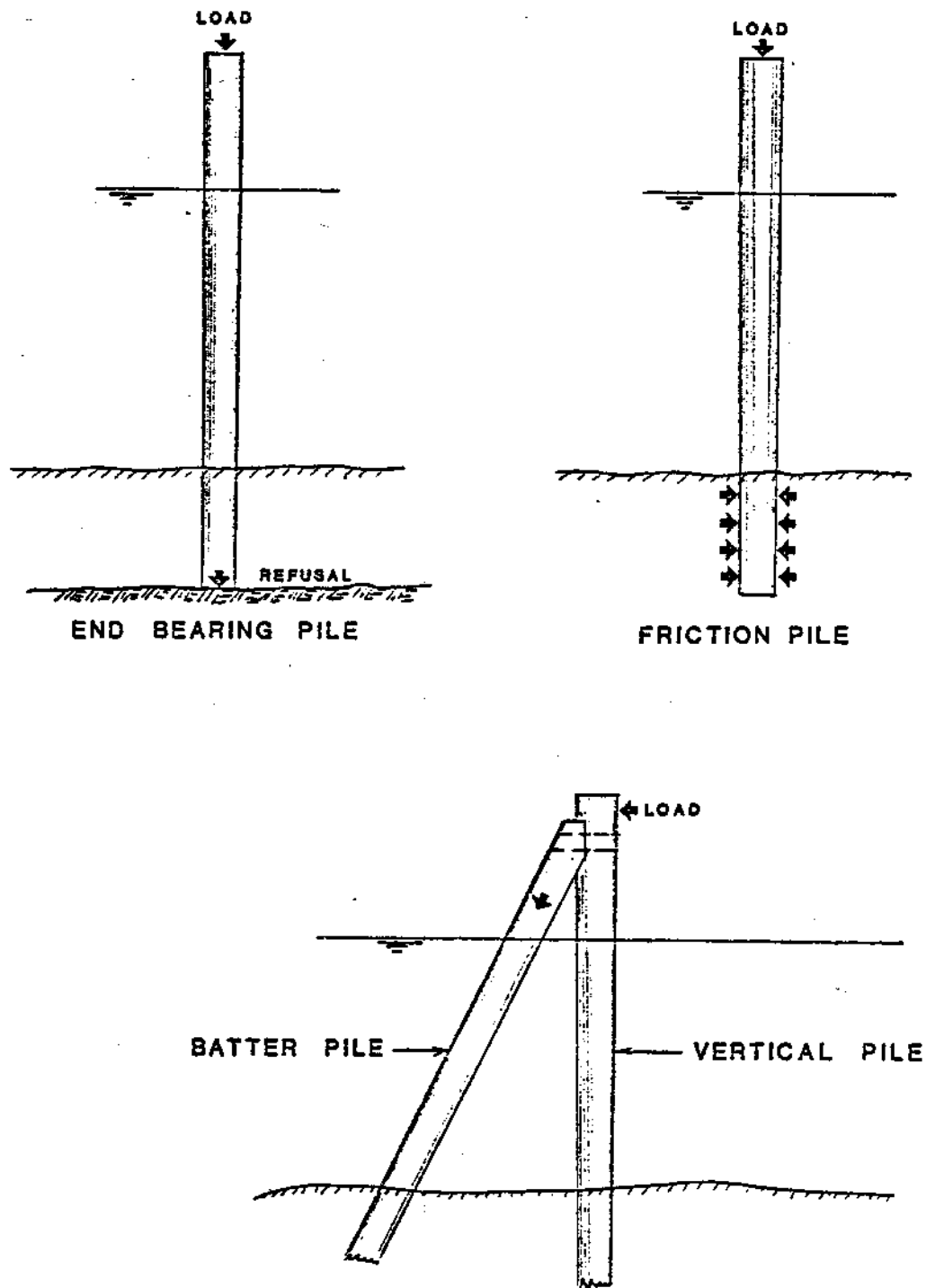

Figure 6.7 Bearing and Batter Piles (Tobiasson, 1979, p. 4)

failure of the pile before it is even loaded. For the above reasons, wood piles must be considered low capacity foundations when compared with steel or concrete piles. This is of little consequence in marina design where the pile spacing is determined by superstructure framing details and only a portion of the piles load carrying capacity is used.

The standard lengths of timber piles are limited by the height of suitable wood species. Southern pine and Douglas fir are the principal species used for treated piling in saline environments. Red pine, Norway pine, Oak, Red cedar and other species are also acceptable if properly treated with preservatives. Southern pine is readily obtained in lengths to 60 ft. (18 m) while Douglas fir is available on the West Coast in lengths up to 100 ft. (30 m). With the low applied loads and shallow water depths typical of the recreational marina, timber piles are rarely found to be inadequate because of their available length.

Unlike load capacity or length availability, rapid deterioration in the marine environment is a serious problem. Timber piling comes under the attack of insects, marine borers, organic decay, and abrasion from boats and scour currents. Protection in the form of a pressure impregnated preservative is required in most cases. Material deterioration and preservative treatment is discussed by Hubbell and Kulhawy (1979a). Encasement in a concrete jacket or various patented methods of plastic wrap have also been used to protect timber piles in saltwater locations where marine organism attack is especially severe (Tobiasson, 1979).

Additional protection must be provided to the top of timber piles where they extend above dock level. First, the top of the pile where it is cut off must be sealed to keep moisture from penetrating the end

grain and starting decay (Chaney, 1961). Chaney suggests that the pile butt be swabbed with creosote, followed by a thick coat of tar and a concrete or cast iron cap (Figure 6.8). Molded plastic or fiberglass pile caps (Figure 6.9) are suggested by Dunham and Finn (1974). The conical shape of these caps sheds the rain and helps keep birds off the piles. Secondly, when creosoted piles are used for support members, the portion above the deck line will always be dark and oily as the creosote seeps out of the wood. To avoid users clothing from coming in contact with this creosote, Dunham and Finn (1974) recommend a wood batten system as illustrated in Figure 6.10. Another alternative is to splice on a salt treated pile butt that is stained to match the creosote as in Figure 6.11.

Several agencies have prepared specifications for wood poles to be used as pile foundations. Among these, the American National Standard (ANSI 05.1-1979), American Society for Testing and Materials (Standards D25 and D2899), and American Wood Preservers Institute (Technical Guidelines P1 through P5) are recommended references for information on wood species, dimensions, general quality, strength, decay resistance, preservative treatment, inspection, splicing, storage, and handling of timber piles.

Steel Piles

Steel piles in the form of H-sections or pipes are widely used for pile foundations. Steel piles are especially applicable to conditions that require hard driving, great lengths, or high single pile capacities. Since H-piles displace relatively small volumes of soil, they are more easily driven than other pile types and are commonly used to reach strong

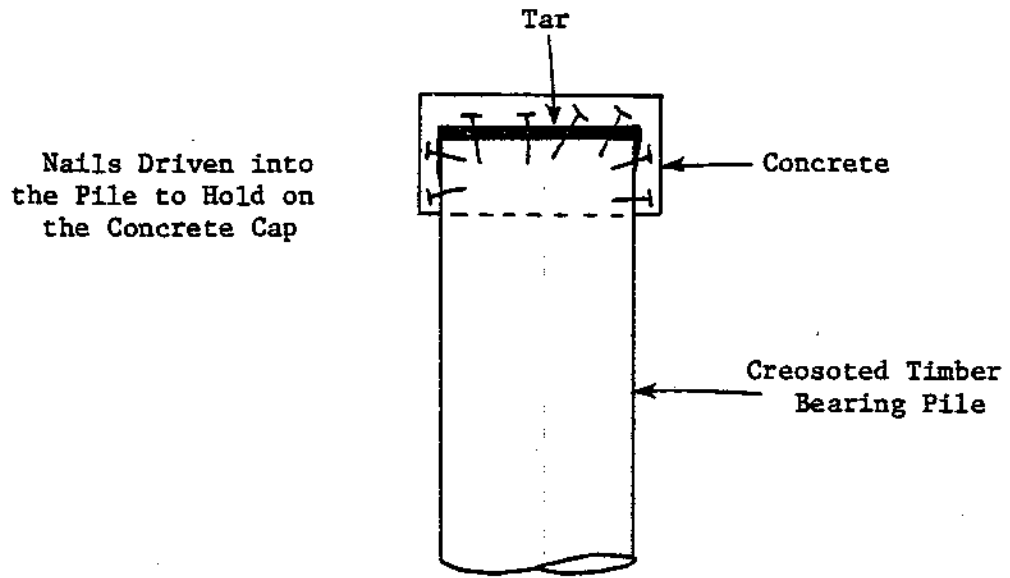

Figure 6.8 Concrete and Tar Cap

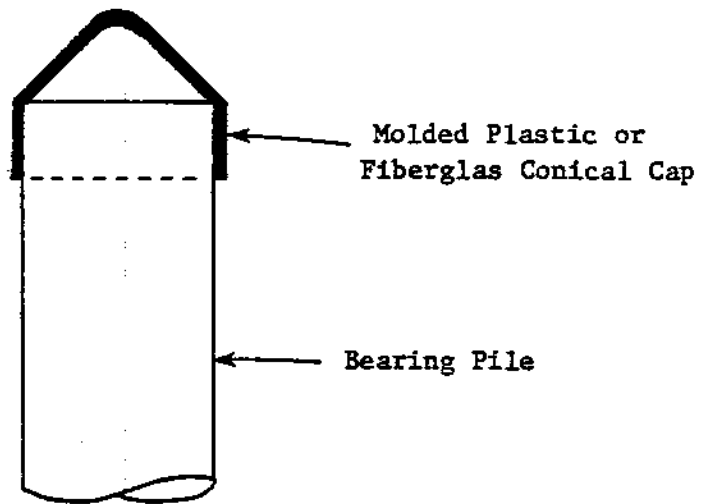

Figure 6.9 Molded Synthetic Cap

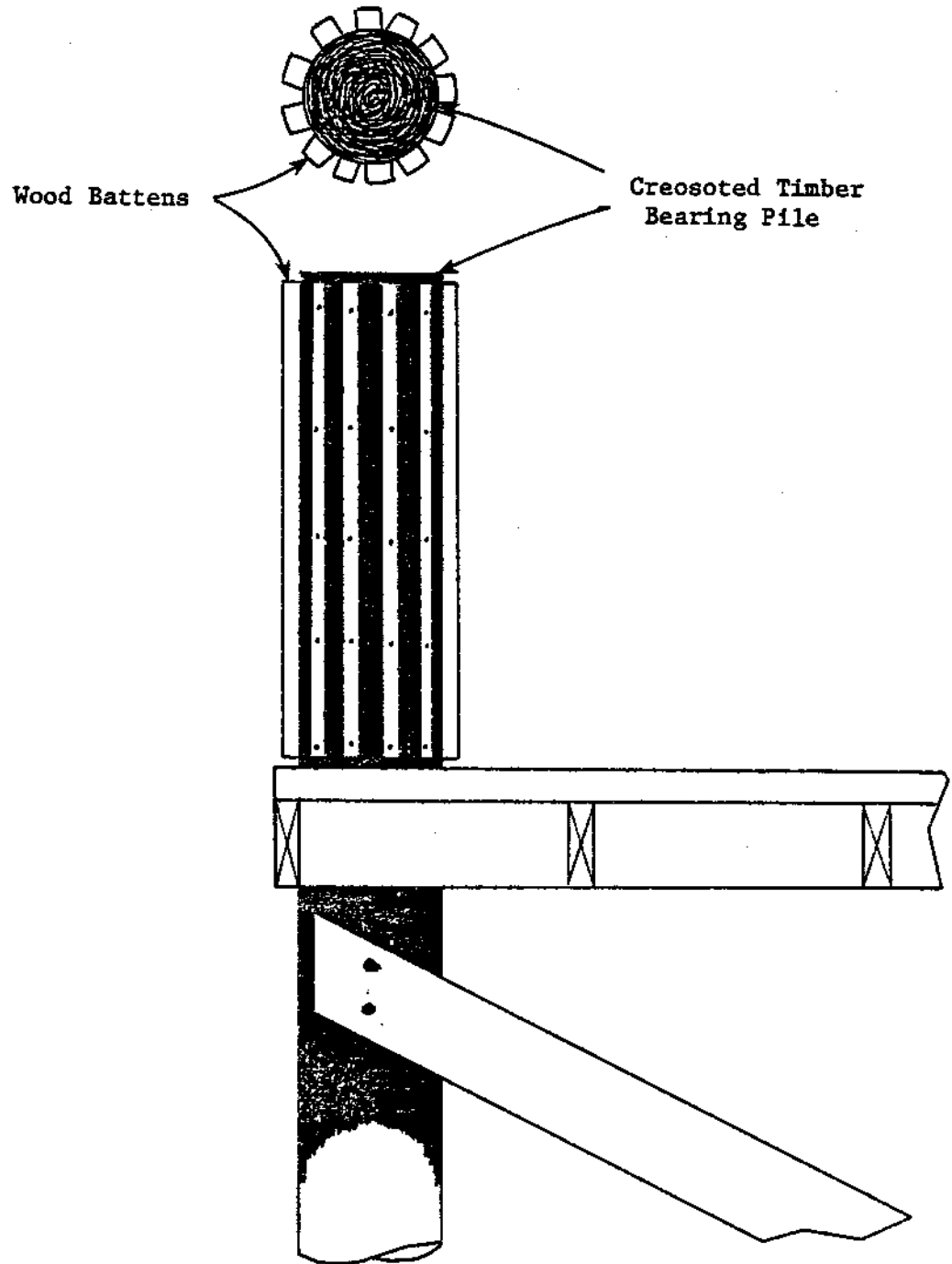

Figure 6.10 Wood Batten Pile Protection

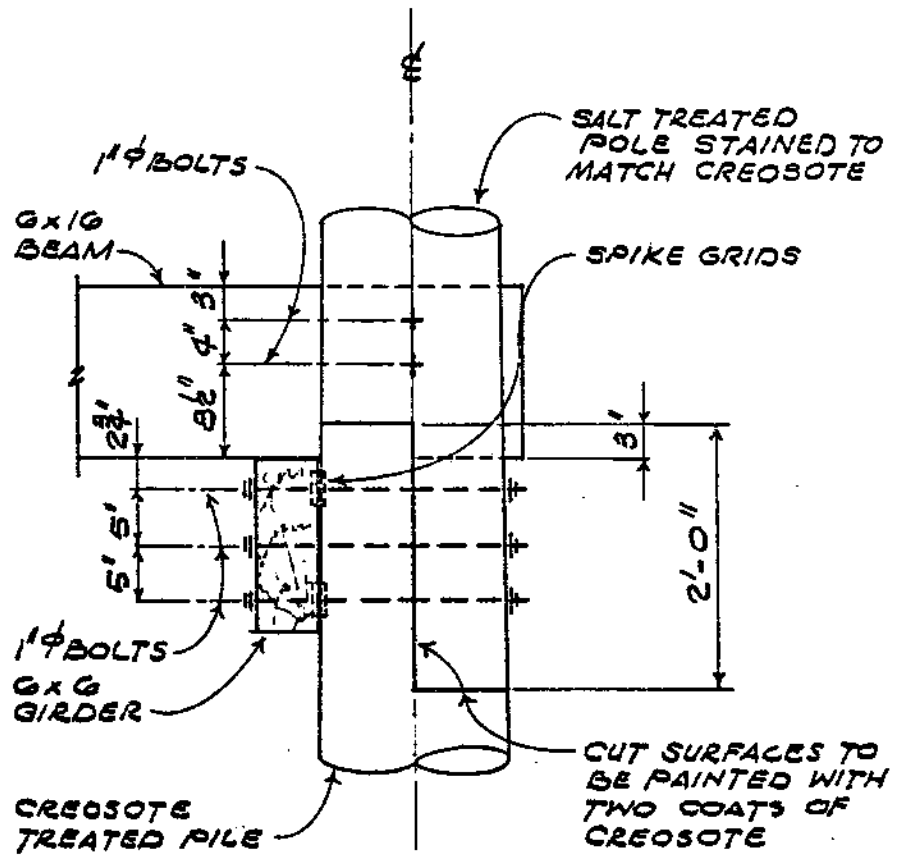

Figure 6.11 Timber Pile Splice Detail
 (Van Blanford, 1970, p. 3)

bearing strata at great depths. Pipe piles capped on the end by flat plates or conical points are sometimes harder to drive than H-piles because of their larger end area. Unlike H-piles which are most efficient in end bearing, pipe piles are more suitable as friction piles. A significant advantage of pipe piles is that they can be visually inspected after driving to identify any damaged casings and allow repair or replacement. Pipe piles are usually filled with concrete to increase their compressive strength and control internal corrosion.

Length is not a critical factor in the use of steel piles since they are easily joined on the job site by welding. At the other extreme, steel piles that are too long can be quickly trimmed to the proper height by oxyacetylene cutting, even under water. Large steel piles are considered very high capacity foundations and are rarely used in marina construction. Smaller sections with correspondingly lower capacities are more suitable but are also more easily damaged by handling and boat impact. As in the case of timber piles, deterioration proves to be the major factor determining the lifetime performance of steel piles.

Deterioration of steel usually takes the form of oxidation corrosion, more commonly called rust. In the tidal range, bare steel exposed to saltwater may corrode up to 0.020 in. (0.5 mm) per year (AAPA, 1964). In such an environment, steel piles must be considered temporary unless some effective form of protection can be devised. Epoxy coatings, concrete encasement, and sacrificial cathodes are some of the techniques that are successful depending on site specific conditions. For example, cathodic protection is not reliable in the tidal zone (Peck, Hanson,

and Thornburn, 1974), and coatings may be worn away by sand blast abrasion near the harbor bottom (AAPA, 1964). Hubbell and Kulhawy (1979a) discuss the corrosion process of steel in the marine environment with various coatings or cathodic protection.

Specifications for steel piles are much less detailed than those for wood because, as a man-made material, steel is much more uniform and predictable. Material properties and standard dimensions for steel H-piles and pipe piles are specified by the American Society for Testing and Materials (1980) in standards A690-77 and A252-77a respectively. Manufacturers of steel piles (Bethlehem Steel Corporation or the U.S. Steel Corporation, for example) also publish product literature and are available for technical consultation.

Concrete Piles

Concrete piles may be divided into two main categories, cast-in-place and precast. Cast-in-place piles may be further classified as cased or uncased. The concrete of a cased pile is poured inside a form that remains in the ground. The form is usually a steel shell or thin pipe that has negligible strength with respect to the structural capacity of the pile. In some ground conditions, the shell may be driven alone, but often it must be supported by an internal driving mandrel to prevent collapse. The mandrel is withdrawn and reused on subsequent piles but it still represents a source of expense and construction difficulties. Uncased cast-in-place piles are less expensive since elimination of the casing lowers the material costs. A mandrel is again driven and withdrawn before or during the placement of the concrete. These piles should be considered only where it is certain that the hole will not be partially

or completely closed by soil stresses after the removal of the shell, since imperfections or discontinuities will result that severely weaken the pile (AAPA, 1964). Waterfront construction with uncased piles presents a problem above the mudline where the concrete is not retained by the surrounding soil. Figure 6.12 illustrates the various types of cast-in-place piles used in North America.

Precast concrete piles have found more extensive use in marine installations (AAPA, 1964). Square, round, or octagonal shapes are common with tapered or constant cross-sections. Conventionally reinforced precast piles generally have pointed driving ends and hollow cores for low weight. Examples of precast conventional piles are illustrated in Figure 6.13. Prestressed, precast concrete piles have also come into general use (AAPA, 1964). Prestressing reduces the incidence of tensile cracking during handling and driving since the piles are stronger in bending when subject to lateral loads and buckling. Theoretically, prestressed piles should therefore be more durable, but Buslov (1979) noted in a study of the durability of wharves that after 15 years in service, "no major differences in performance were found between regular and prestressed piles."

The load capacity of concrete piles is highly variable depending on cross-sectional area, concrete quality, thickness of the steel shell, and the amount of reinforcing steel. Very large concrete piles are of medium to high capacity, being somewhat less than large steel piles but considerably greater than the average timber pile. As in the case of steel piles, only smaller sections have found extensive use in marina construction since high single pile capacity is rarely required.

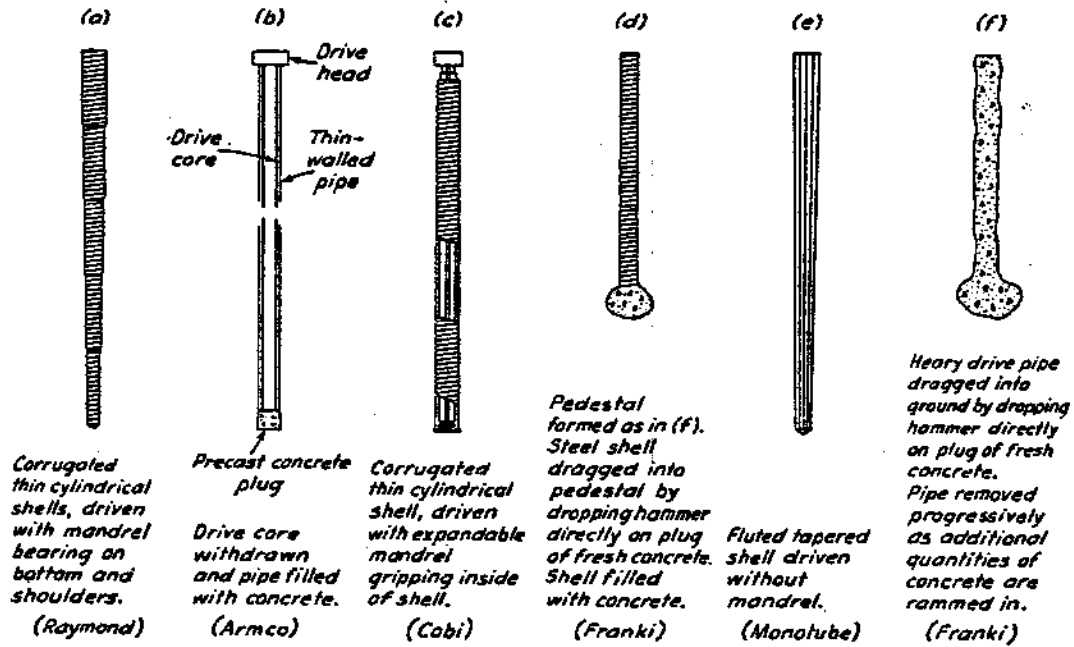
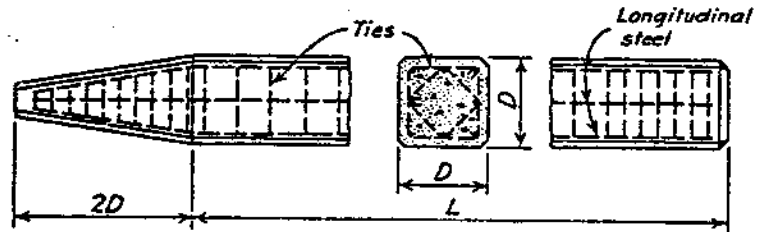

Figure 6.12 Examples of Cast-in-Place Concrete Piles (Peck, Hanson and Thornburn, 1974, p. 205)



(a)



(b)

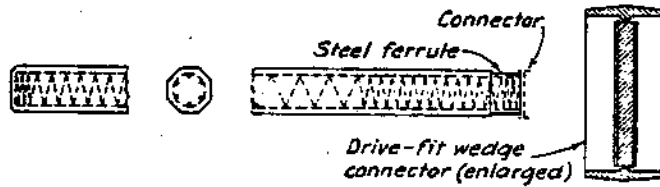

(c)

Figure 6.13 Examples of Precast Concrete Piles
(Peck, Hanson and Thornburn, 1974,
p. 206)

High quality concrete piles are very durable and are essentially permanent where they are entirely embedded in soil. Special types of cement are available to resist the attack of ground water sulfates where they are found to occur. The portion of the pile above the mudline is subject to deterioration by abrasion, freeze-thaw, and cover spalling. These topics and the proper methods of protection are addressed by Hubbell and Kulhawy (1979a).

Specifications for conventional and prestressed precast piles are available from the Portland Cement Association.

Composite Piles

Piles that consist of one type of material for the lower portion and another type of material for the upper part are considered composite piles. The most common type that has been used is an untreated timber pile supporting a cast-in-place concrete upper (AAPA, 1964). The untreated timber is terminated below the permanent water table where the oxygen content is minimal and decay processes are therefore very slow. The compressive strength of the timber pole limits the load that can be supported by a wood/concrete composite pile such that it must be considered a low capacity foundation.

Where high load capacities are required, composites of steel and concrete may be used. A concrete filled steel pipe lower section with a concrete top can be driven to high resistance to develop high load carrying capacity in friction. Steel H-piles are used as the lower section to obtain better penetration when end bearing is expected.

Another variation that is not a true composite pile is when a timber or steel pile is encased in concrete to protect the top portion from

deterioration and damage. In this case, the concrete shell is intended to be sacrificial rather than a load carrying element.

The most critical part of composite pile design is the joint between the upper and lower sections. This joint must be both water tight and capable of withstanding tensile and bending stresses. It should also be fast and economical to produce in the field so that pile driving progress is not interrupted. Peck, Hanson, and Thornburn (1974) state however that "the cost and difficulty of forming a suitable joint have led to the virtual abandonment of this type of construction in the United States and Canada."

6.3 SELECTION OF PILE TYPE

As the previous sections indicate, the various types of piles are best suited for different applications. Several factors should be considered when selecting pile material including availability, durability, strength, and estimated costs. Appearance is also a conceivable criterion for material selection but will not be addressed here because of its subjective nature.

While timber, steel, and concrete products are all readily available throughout most of the United States, they must be transported to the construction site. Availability is a factor then, not because the materials are scarce, but instead because of shipment and handling problems. Timber piles are light, strong in bending, and usually in lengths of less than 60 ft. (18 m). They can be easily shipped by land carriers with little concern for damage and at relatively low cost (AAPA, 1964). Steel is much heavier per foot of pile and is much more expensive to ship. Heavy equipment is required to handle

steel piles, but their excellent strength characteristics prevent damage. While short lengths may be shipped by land carrier, with splicing performed on the construction site, it is preferable to use full length piles. Special heavy equipment is also required to ship and handle precast concrete piles. Their weight and length makes them costly to ship unless they can be transported by barge. Multiple pickup points or strong-backs are usually used when handling concrete piles in an effort to reduce the bending stresses incurred that may cause tensile cracking. Once in place, these cracks could act as a pathway for water to reach the reinforcing steel. Prestressing minimizes this problem, but durability may still be adversely affected.

Durability must be measured in terms of the intended design life of the structure. Although the deck superstructure of a fixed dock, pier, or wharf is relatively easy to repair, its pile foundation is both difficult and expensive to replace. Material deterioration depends on site specific conditions such as the level of the permanent water table, the presence of insects and borers, groundwater chemistry, and scour related abrasion. Piles should be selected carefully with respect to the environment they will be placed in and the service life expected. Some manner of preservative treatment is usually required for piles to achieve a reasonable design life. Hubbell and Kulhawy (1979a) discuss material deterioration and protective methods for timber, steel, and concrete in the marine environment.

Foundation pile capacity is more often limited by the surrounding soil conditions than by the pile axial compressive strength. Material strength is important, however, during handling and driving operations

to avoid structural damage to the pile. Sizeable bending stresses are induced by the pile weight in beam-like loading as it is moved from transportation to storage to the pile driving rig. Both timber and steel have excellent tensile strengths (per unit weight). Concrete, however, has small tensile strength and must be reinforced with steel bars or mesh. This reinforcement is often a major cost item but may be reduced by extra care in handling or by prestressing.

The final and often controlling factor in the selection of pile type is cost. To be consistent, costs for each material must be compared over the anticipated structure design life. Included must be installation and maintenance costs with installation covering such areas as pile purchase, preservative treatment, transport, handling, splicing, driving, and cut-off to the finished elevation. While timber piles may have the lowest cost after installation, other materials could be favored because of environmental conditions that cause excessive maintenance costs.

6.4 DESIGN AND INSTALLATION OF PILE FOUNDATIONS

The capacity of a pile foundation depends on many factors such as the properties of the soil mass, the dimensions and material properties of the pile, the method of installation, and the loading conditions imposed. These topics are covered in detail by Cheung and Kulhawy (1981) and will not be presented here.

6.5 DECKING AND FRAMING DESIGN CONSIDERATIONS

Subsequent to the construction of the pile foundations for a fixed dock, pier, or wharf, the deck superstructure must be erected. The piles are first trimmed to the proper elevation, followed by the installation

of the bracing and pile caps to finish each pile bent. Next, the stringers or beams correlating each bent are installed and the deck is placed to complete the structure. The following discussion addresses the design considerations of each of the components mentioned above.

A well designed fixed dock, pier, or wharf must satisfy several seemingly non-essential criteria. Poor appearance, smell, or "feel" may discourage potential users of an otherwise adequate facility. The latter of these is probably the most difficult to quantify. In fact, Chamberlain (1979) has said that "one of the worst faults in marina structure, whether fixed or floating, is a lack of rigidity, or at least a sense of rigidity." This "sense of rigidity" may be achieved in one of two ways. Gross overdesign of all the structural members and connections will result in a solid, stable structure at unnecessary expense. This approach may be justifiable for very small facilities where the savings in design fees compensate for the added material costs, or where the design loads cannot be properly quantified. A more reasonable approach, certainly for larger projects, is to consult a competent structural engineer familiar with marina design. After an analysis of structural geometry and design loads, each structural member and connection may be designed for the loads it must carry, achieving structural integrity at lower overall cost.

It is not within the scope of this report to present the structural design philosophy and procedures for each of the components to be addressed. Structural design criteria for fixed timber docks and piers are presented by Chaney (1961). Dunham and Finn (1974) note that the design criteria for steel and concrete fixed-level berthing systems

are similar to timber construction except for the connection details and the magnitude of the dead load.

Two additional aspects of structural engineering bear mentioning at this point. While it is the designers duty to account properly for the anticipated loading conditions, it is the responsibility of the marina owner or manager to see that the design loads are not exceeded. The failure of a structure that has been improperly used (overloaded) will be identical to one that is structurally inadequate to begin with.

Secondly, the ease with which maintenance can be performed is largely a function of the design (Tobiasson, 1979). With regard to maintenance, a design which minimizes the potential for rot, corrosion of fastenings, and deterioration of main members is advantageous. For timber structures, holes should be predrilled and all cuts should be made before pressure treatment. Where this is not possible, and the timber must be bored or cut during construction, all open surfaces should be coated with preservative. Holes, joints and splices below the water line should be avoided. Timber pile tops must be waterproofed immediately after cut-off. Chamberlain (1977) notes that treated wood may not meet treatment specifications, and recommends that a clause requiring an independent assay of the wood be included in a specification for wood construction. The most common problem in concrete construction according to Buslov (1979) is "corrosion deterioration". This phenomenon occurs as moisture reaches the reinforcement steel and it starts to rust. It is usually most intense on lower horizontal surfaces and may be because of poor quality concrete, inadequate cover over the reinforcement, or a combination of the two. Corrosion deterioration is much

less a problem in precast elements because quality control is usually better. Finally, Tobiasson (1979) states that prompt repair of damaged structural components aids in reducing maintenance costs since local damage often leads to accelerated deterioration elsewhere.

Bracing

The purpose of bracing pile supported structures is to resist lateral loads, and to stiffen the structure to reduce side and end sway. Excessive sway is equivalent to lack of rigidity which is the primary cause for a dock or pier to "feel" unsafe. Bracing consists of batter piles, x-bracing, or knee braces as illustrated in Figure 6.14. Batter piles are driven at an angle to provide a horizontal load resisting component either in tension or compression. X and knee braces effectively reduce the free length of the pile above the mudline that is available for bending, thus stiffening the system and reducing lateral deflections. X-braces usually consist of steel tie rods or wood members. The tie rods are typically 5/8 to 3/4 in. diameter (16 to 19 mm) and are fitted through drilled holes that have been flooded with preservative (AWPI, 1975b). Note that they are only effective in tension since they are slender members. Wood x-bracing is constructed by bolting treated wood planks, typically 2 x 6 in. (51 x 152 mm) or 2 x 8 in. (51 x 203 mm) lumber, to the front and back face of a pile bent. Knee braces are similar but do not extend the full width of the bent.

Batter piles are the most effective means of reducing horizontal movement under lateral load. They are also more expensive than x or knee bracing and are difficult to replace if damaged. Chaney (1961) recommends that the batter pile be framed into the bearing piles as

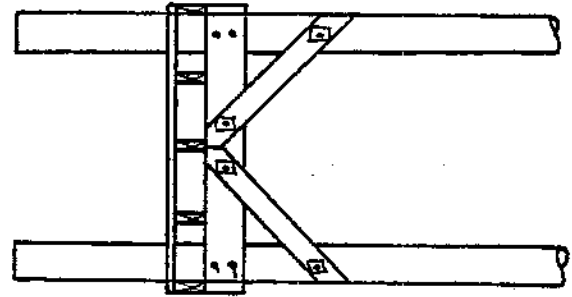

C. Knee Brace

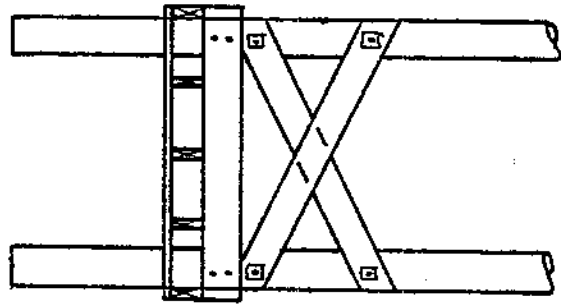

B. X - Brace

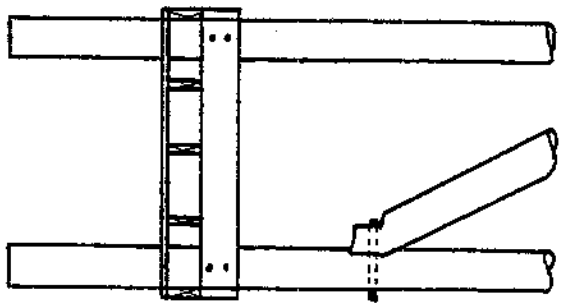

A. Batter Pile Brace

Figure 6.14 Types of Fixed Pier Bracing

near the low water line as practical to minimize decay. In the event that decay of the upper portion of a bearing pile requires that it be spliced, a low batter pile connection will retain its full bracing strength.

Of the three bracing systems mentioned, knee braces are the least effective means of controlling horizontal deformation, but are substantially better than no bracing at all. Both x and knee braces are easily installed by hand labor and may be repaired or replaced easily while the structure is in service. To retain its integrity, the connections of these braces must allow no slack so bolts alone are not adequate. Most references suggest a single-curve spike grid but that will be addressed in a subsequent section on connections. Care must be taken in using x or knee braces in cold regions where ice drift will loosen connections and knock the braces loose from the bearing piles (AWPI, 1971).

File Caps

The pile cap serves to distribute the loads from the stringers above among the piles of one bent. Two general configurations have been used, including a single member resting directly on the pile butts, and separate members attached to the sides of the piles (Figure 6.15). The second type is known as a "split-cap" and is favored for its ease of construction and because the piles may then extend up through the deck to support handrails, hose bibbs, fire extinguishers, electrical outlets, lights, and mooring hardware.

While timber, steel, and concrete are all used for pile caps, timber is again the most common. Chaney (1961) suggests that timber piles

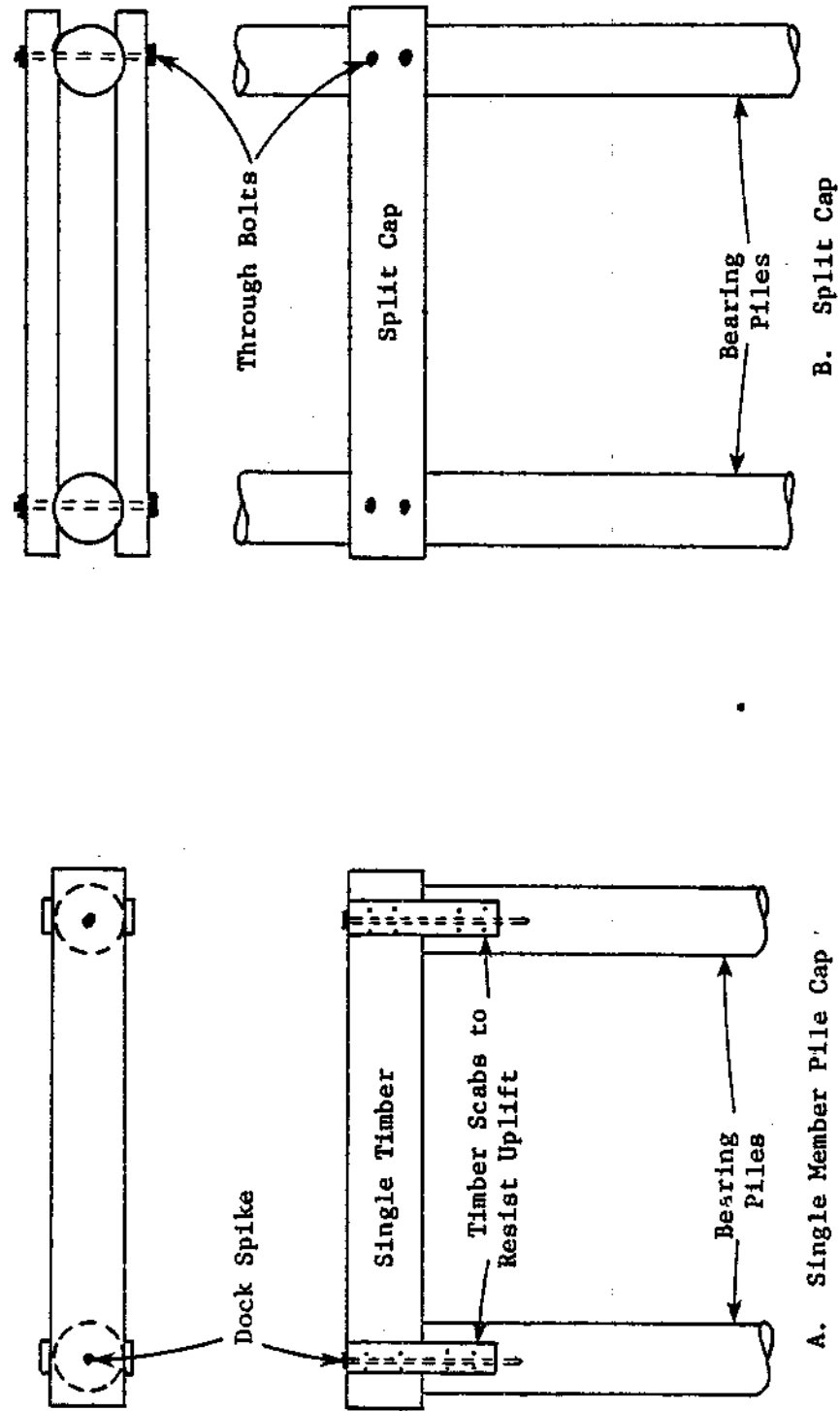

Figure 6.15 Pile Cap Types (After Quinn, 1972, p. 277)

should be "dapped" or relieved about 1 in. (25 mm) when using split caps so that part of the load is taken in bearing and smooth surfaces are available for attachment. Timber cap size has traditionally been based on local experience with typical sizes of 12 x 12 in. (300 x 300 mm) for a single member or two 6 x 12 in. (150 x 300 mm) for a split cap (Tobiasson, 1979). In many cases, however, these members are grossly overdesigned, and economy may be achieved with the use of smaller members specified by a structural engineer after analysis of the structural geometry and design loads. Member sizes for concrete and steel pile caps are determined similarly.

It is usually difficult to drive piles to precise positions. As such, it may not be practical to use precast concrete pile caps since the connections would have to be preformed. Cast-in-place concrete pile caps, however, easily accommodate small pile deviations and still form excellent connections. Some of these connections are illustrated in Figure 6.16 for various pile types. Buslov (1979) cautions that severe spalling of cast-in-place pile caps has been observed at expansion joints, recesses for nuts and bolts, and lower surfaces which are damaged by main bar reinforcing corrosion.

Stringers

The stringers of a fixed dock, pier, or wharf lie between each pile bent and support the decking (See Figure 6.4). These stringers are very important in determining structural geometry and overall cost. While it has been noted that the pile foundations are the most expensive component of a fixed dock, the number of pile bents required is determined by the length of the stringers above. Longer

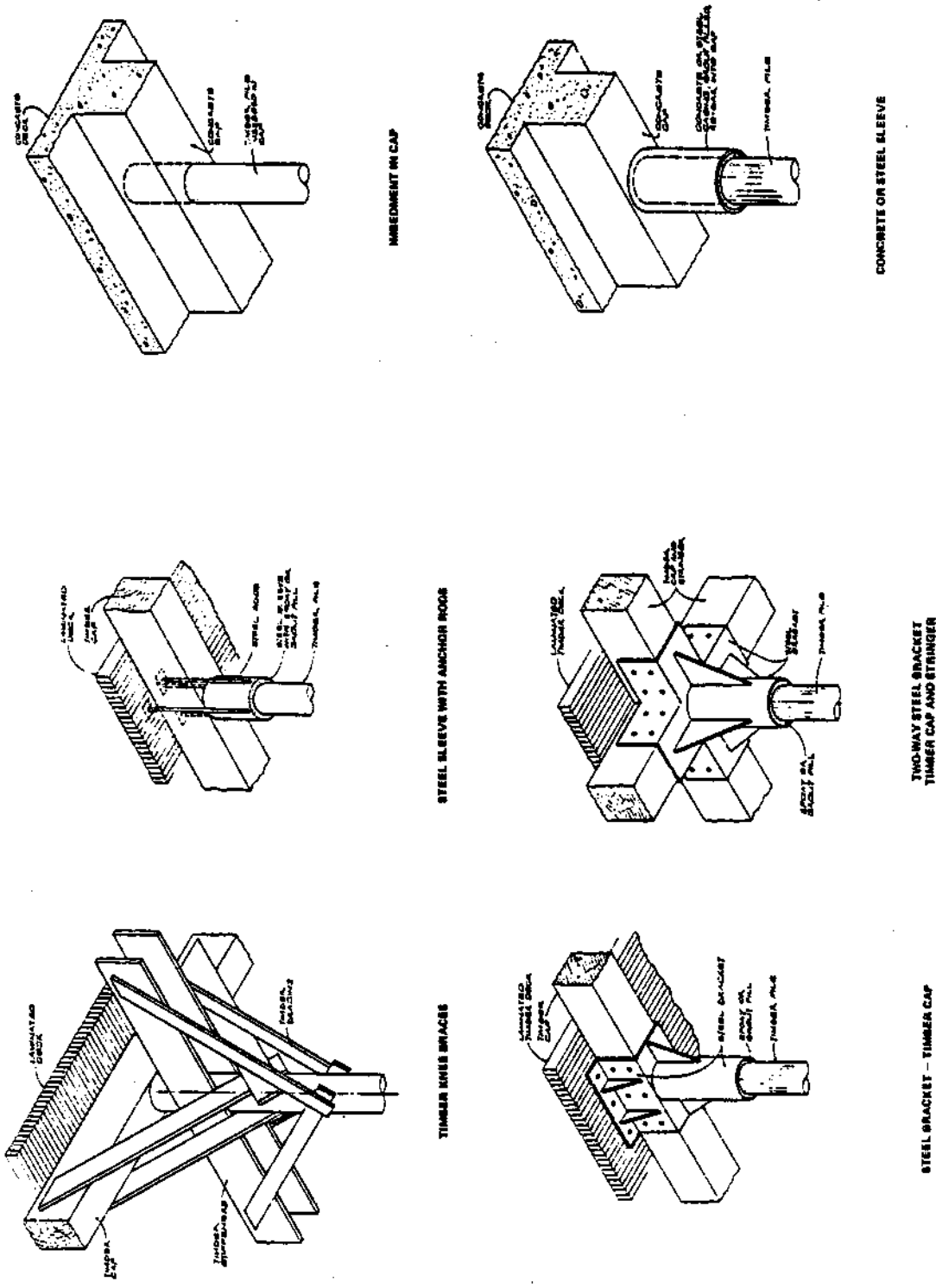

Figure 6.16 Typical Pile to Superstructure Connections (AWPI, 1968, pp. 9, 10)

spans mean fewer piles at reduced cost.

The practical maximum span length depends on material strength as well as the standard sizes available. Concrete stringers are precast (Buslov, 1979) and may be formed to any desired dimension. Dunham and Finn (1974) propose a prestressed, precast concrete deck system that combines deck and beam properties in a single element (Figure 6.17).

Stringers may be designed as simple beams under a continuous uniform deck load or concentrated point loads as discussed in Chapter 3.

Decking

The decking of a fixed dock, pier, or wharf structure must satisfy several design criteria in addition to structural integrity. It must be durable, slip-proof, easily repairable, clean, and preferably attractive. The most common decking materials are timber, steel, concrete, and aluminum (Tobiasson, 1979). The metal decks are less cost effective than timber or concrete, and their use is usually limited to gangways and ramps.

Timber decks have traditionally been constructed of 2 in. by 6 in. (50 mm by 160 mm) wood planks spaced approximately $\frac{1}{2}$ in. (7 mm) apart (Dunham, 1969). Thinner members have been found to be too flexible and may break under concentrated loads. The planks should be laid with the proper grain orientation (Figure 6.18) to encourage water runoff as they warp with age. They are often installed diagonally (Figure 6.19) to stiffen the dock structure in the horizontal plane and to strengthen the finger pier-walkway connections. Chaney (1961) recommends that the wood be a wear-resistant species such as oak, maple, or black

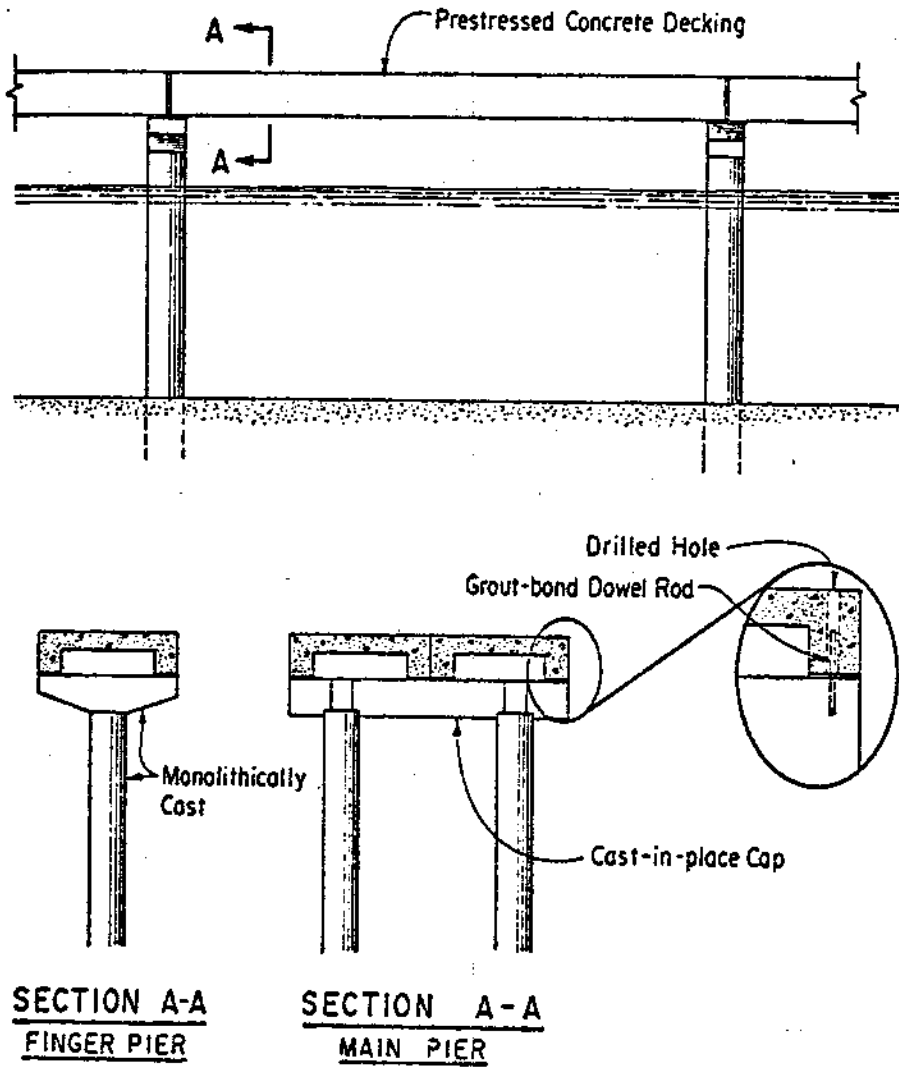
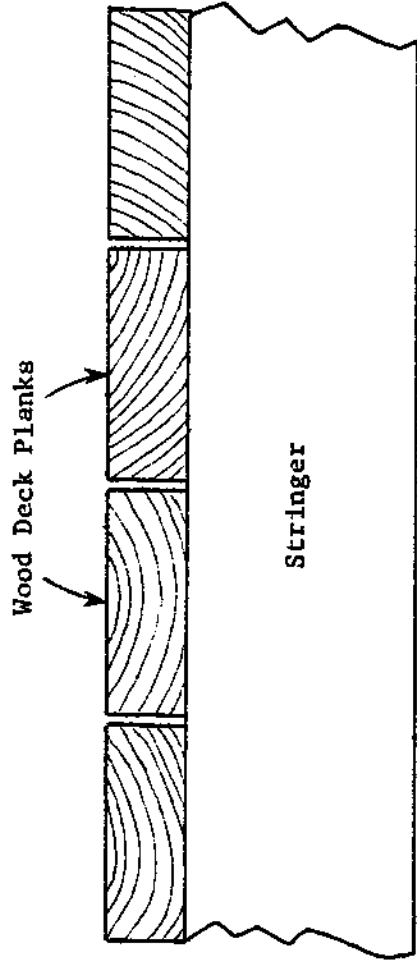

Figure 6.17 Prestressed, Precast Concrete Deck System (Dunham and Finn, 1974, p. 121)



Decking is Placed With Growth Rings Oriented Concave Up.

Figure 6.18 Proper Grain Orientation for Wood Plank Decking

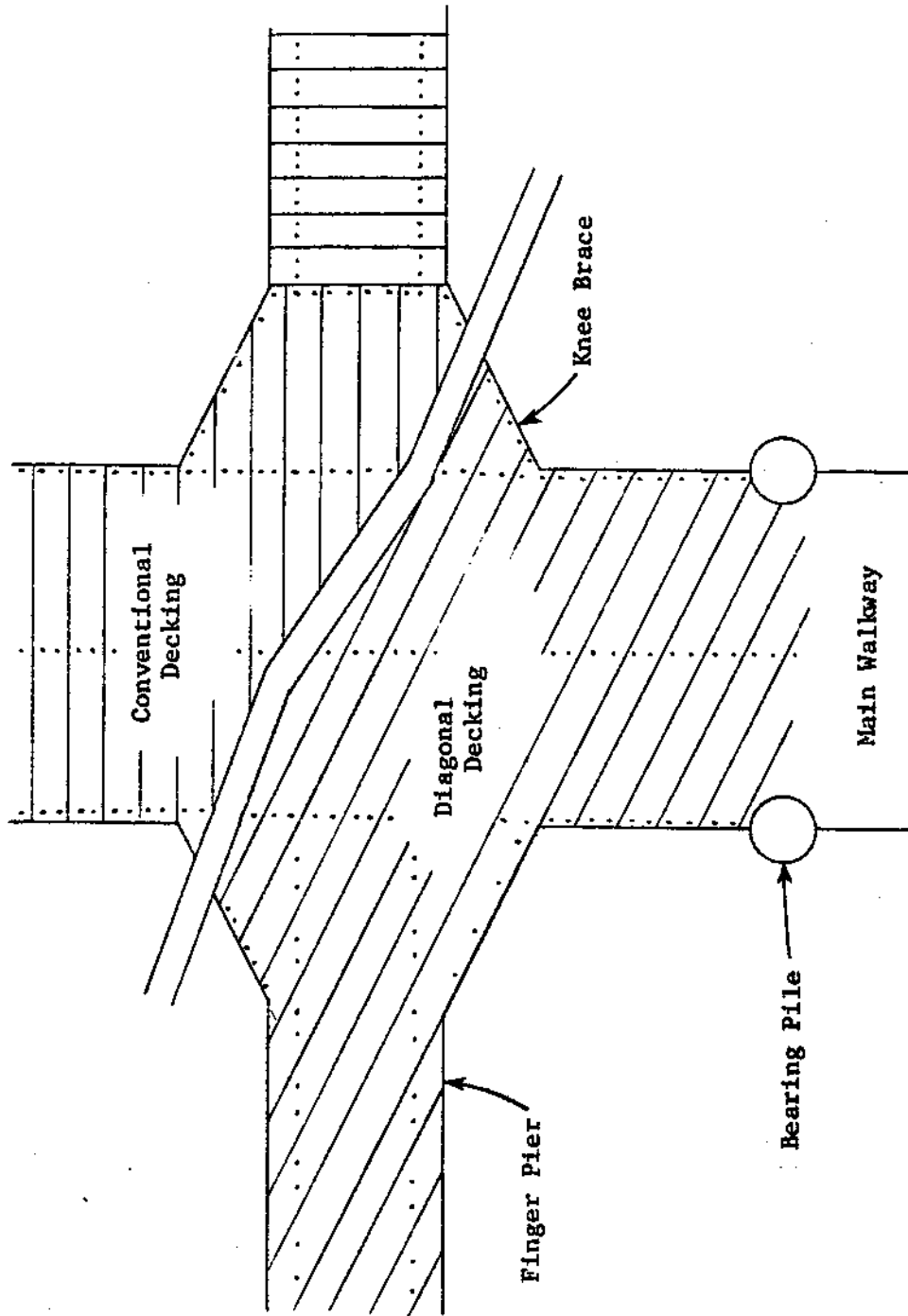

Figure 6.19 Diagonal Deck Planking

gum. Redwood decking is very attractive but should be avoided because of its poisonous splinters (Dunham, 1969). Deck timbers must be treated to obtain a reasonable service life, but creosote should not be used (Koelbel, 1979). Creosote bleeds out of the wood and sticks to shoes, clothing, and boats, and discourages customers in the long run. Pressure impregnated salts are a much cleaner solution.

Exterior grade plywood has also been used as a decking material. According to Dunham (1969), 3/4 in. (20 mm) thick plywood provides greater structural strength in cross-bracing than 2 in. (50 mm) wood decking. To avoid delamination with age, plywood decks must be kept painted. Exterior house paint mixed with 1/2 lb. (0.23 kg) of coarse ground pumice per gallon (4.2 l) will give a satisfactory non-slip surface (Dunham, 1969). Plywood deck panels with a bonded synthetic non-slip surface are available from marine materials manufacturers at greater costs but correspondingly lower maintenance and longer life.

Sheet metal deck panels of steel or aluminum have found limited application on marine structures. These open grating type decks are suitable where deck areas are small or on gangways where low weight and good traction are required. Dunham (1969) indicates that while metal decks have performed acceptably in fresh water environments, their use is not recommended around salt water because of corrosion problems.

Concrete decks may be either precast or cast-in-place; in either case, they are more massive than timber or metal decks. Since heavier supporting systems and piles are then required, concrete decks are typically used on larger structures. A concrete dock may be designed as a one-way slab, a two-way slab, or as a "T-beam" which combines the

deck and girder in one element. While thin elements are not recommended (Chaney, 1961), properly designed concrete decks are durable, economical, and especially suitable to areas subject to marine borer attack.

Tobiasson (1979) suggests that curing compounds be used to densify the top surface of the concrete to make it less permeable to water. Flexible expansion joints should also be provided to minimize cracking.

Gangways

The deck level of a berthing system is often lower than the marginal wharf on the harbor perimeter. When this is the case, some ramp or transition zone is necessary for ease of access to the berths. If the change in elevation between dock and wharf level is small, the difference can be accommodated by a sloping section of deck similar to the rest of the dock. Since this section should have a maximum slope of 1 vertical to 3 horizontal (State of California, 1980), its vertical rise is limited by its length which is a function of stringer size and design load. Gangways or "brows" are used when the vertical rise is too great for a sloping deck, or when a gentler slope is preferred (Figure 6.20). The handrail of most gangways doubles as a truss to help support the deck and increase the allowable span length.

Connections and Hardware

Joint design is probably the most involved and neglected element of timber structure construction, according to Chaney (1961). Presumably the same is true for steel and concrete design, although their material properties are much more predictable. Constructing a joint usually entails connecting various structural elements with some sort of fastener

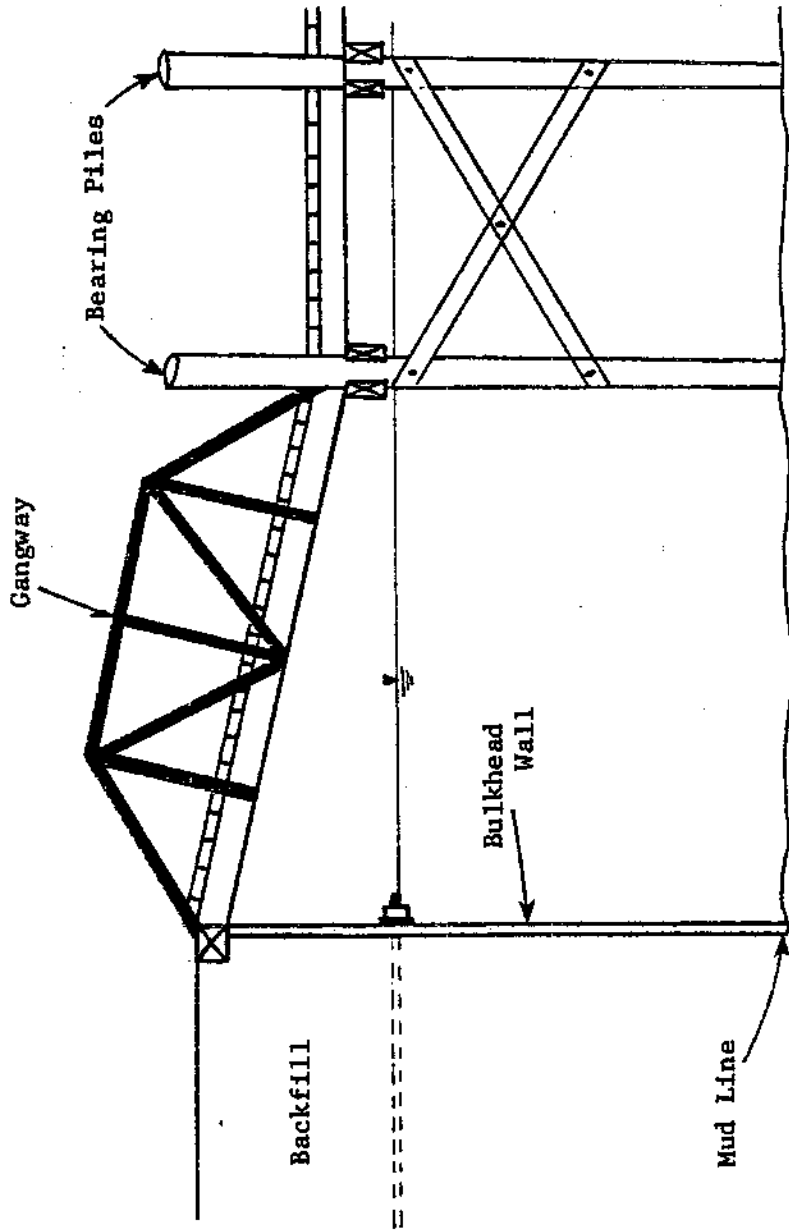
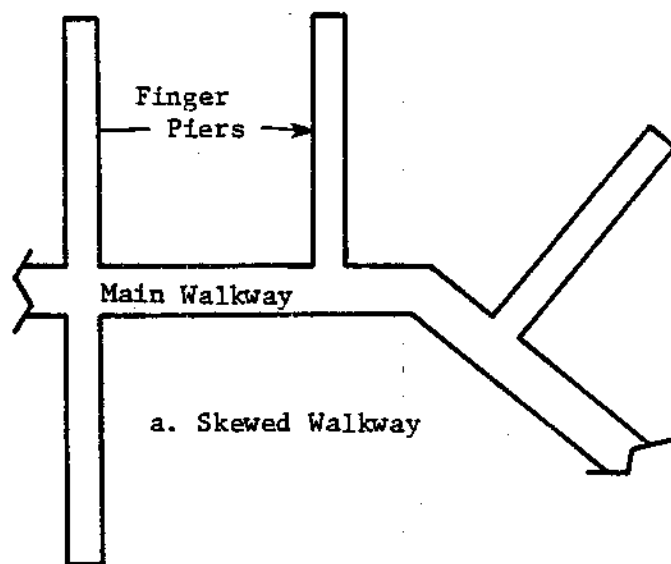

Figure 6.20 Fixed Pier Gangway

or hardware. The joint must transmit the full force of its members with approximately the same (but no less) stiffness. If the joint is either less stiff or weaker than the rest of the structure, large deflections may result that lead to fatigue failure. Joint stiffness is a function of connection geometry, material properties, and type of fastener used. Discontinuities in finger pier and walkway alignment (skewed walkways or pinwheel fingers as in Figure 6.21) are examples of poor structural geometry that lead to stress concentrations and a higher degree of sheared bolts and loosened joints (Curry, 1979). The following discussion presents the types of fasteners used for marina construction, followed by a brief review of joint design considerations.

Hardware, for the purposes of this report, refers to the fasteners necessary to hold a connection together. A greater number of fasteners are used for wood joints than for steel or concrete because of the complex nature of wood connectors. The bolted joint is the most common for timber dock, pier, and wharf construction. Other timber joint fasteners include washers, split rings, spike grids, screws, drift pins, nails, and shear plates (Figure 6.22). Washers are used to distribute the compressive stresses under bolts and avoid crushing the wood fibers. Split rings are installed in precut grooves of timber-on-timber joints to increase their axial shear strength (Timber Engineering Company, 1956). Split ring joints are highly resistant to loosening because of vibration, impact or cyclic loads, and are most suitable for completely prefabricated structures. Spike grids are used in similar wood-to-wood connections where prefabrication is impractical. Ordinary wood screws are seldom used in structural applications because they require significant labor to install, and while they have higher withdrawal



b. Pinwheel Pier

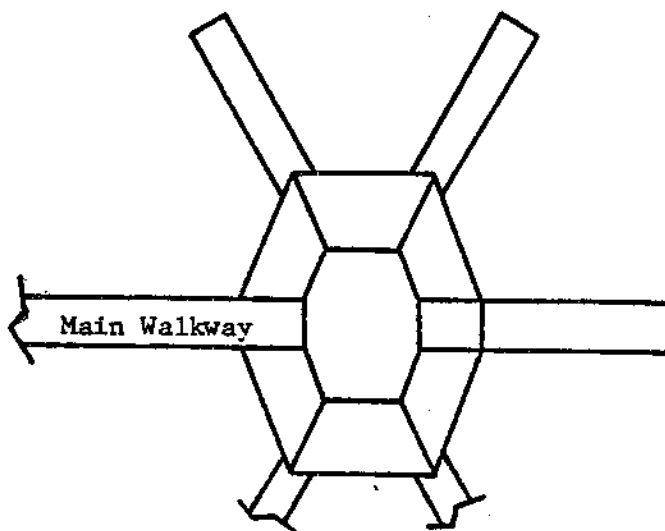
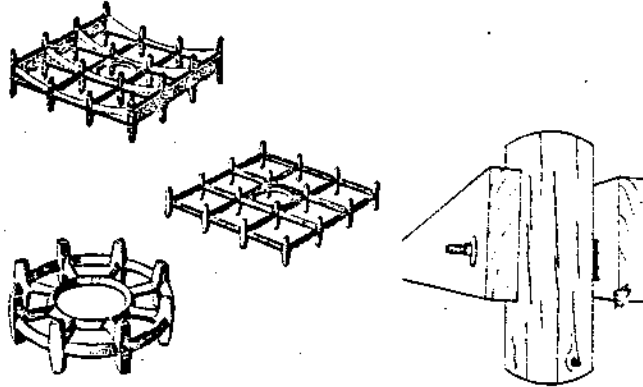
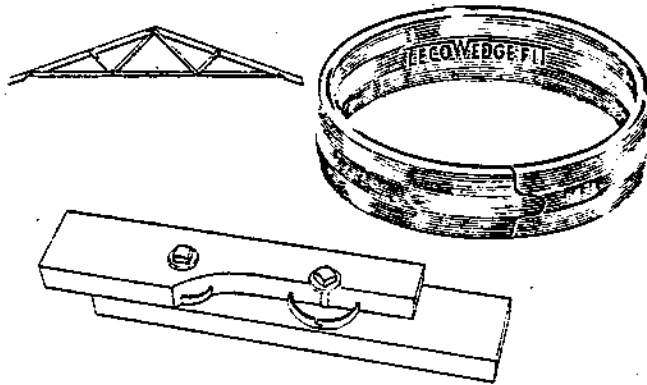

Figure 6.21 Finger Pier or Walkway Misalignment

SPIKE GRIDS



SPLIT RINGS



SHEAR PLATES

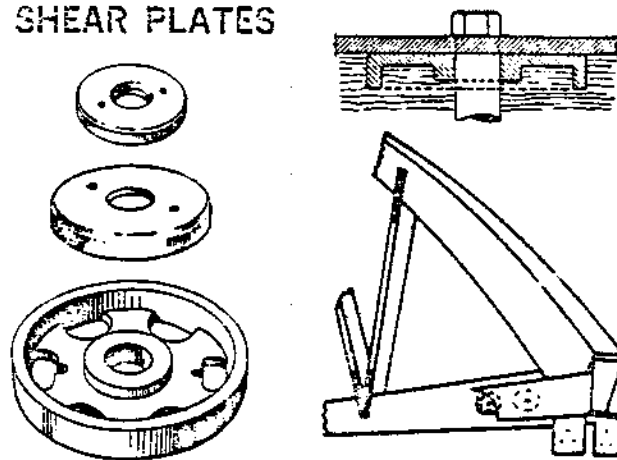
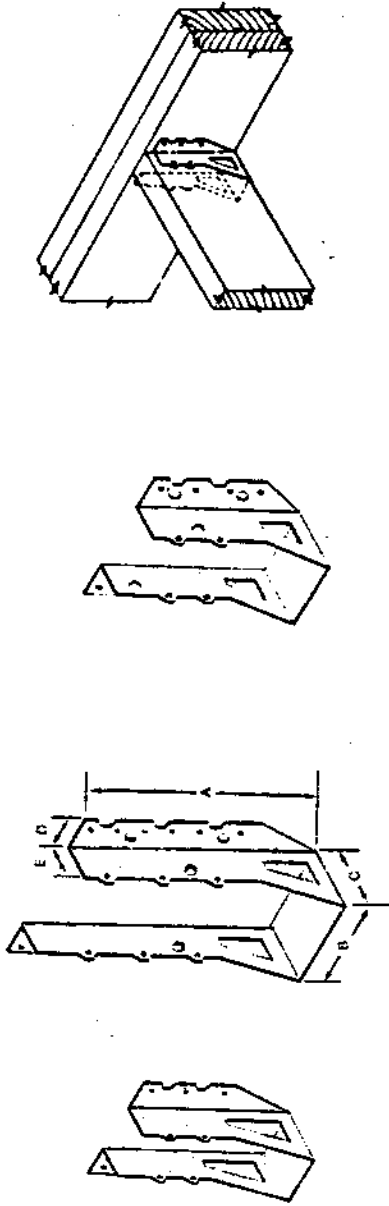

Figure 6.22 Timber Joint Fasteners
(TECO, 1978, pp. 12, 15)

resistance than nails, such loading should be avoided if possible (Timber Engineering Company, 1956). Lag screws, however, are the connector most often used when a through bolt is impractical. Since they are inserted in predrilled holes and turned into place, they can be retightened if shrinkage of the wood or flexure causes them to loosen. Drift pins are also installed in predrilled holes but are driven into place rather than turned. They are often used to anchor heavy timbers to the tops of piles or beams. Nails and spikes are driven into wood members without predrilled holes, and must be loaded in shear since they have relatively low withdrawal resistance. While grooved or spiral nails resist loosening better than smooth nails, Chaney (1961) notes that nailed joints may work loose under repeated flexure. Nails are often used in conjunction with framing anchors or joist and beam hangers (Figure 6.23) to eliminate toe-nailing and improve the joints shear strength. Finally, shear plates (See Figure 6.22) are used in steel-to-wood connections or for timber joints that may need to be dismantled. Like split rings, they are installed in precut grooves but are flush with the timber face when in place (Timber Engineering Company, 1956). The design of wood connections using all of the above mentioned fasteners is presented in the "National Design Specification for Wood Construction" (National Forest Products Association, 1977, Supplement 1978).

The principal methods of connection in steel construction are bolting and welding. High strength bolts have replaced rivets because of their ease of installation and higher initial tension that keeps the joint from loosening under dynamic loads. Bolts are also easily removed when dismantling or repair work is required. In situations where dismantling

joist and beam hangers



framing anchors

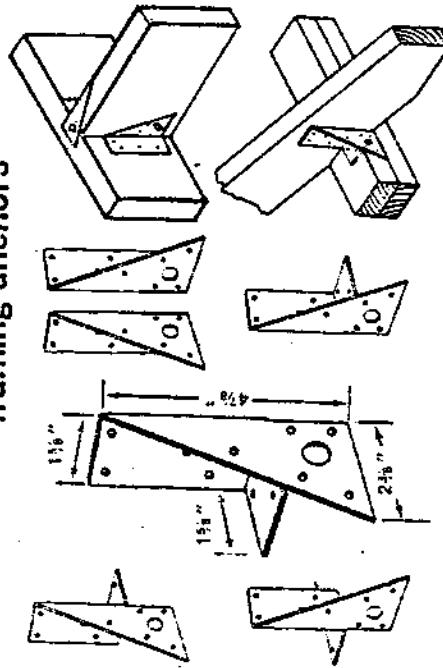

framing anchors

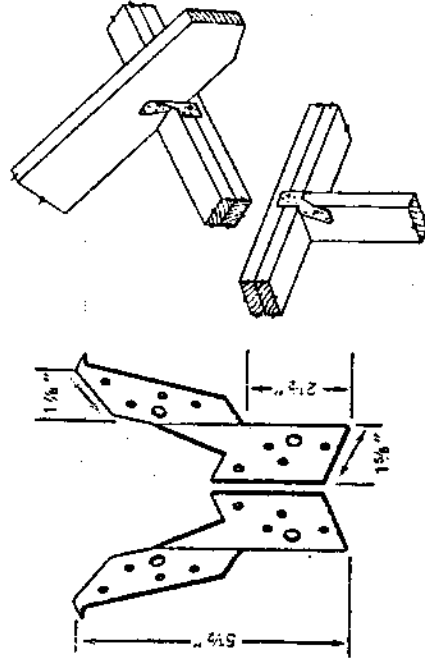

Figure 6.23 Joist and Beam Hangers and Framing Anchors (TECO, 1978, pp. 3, 4)

is not critical, welded connections are prevalent. Welding allows reduced weight through elimination of secondary members such as gusset plates and connection angles (Chaney, 1961). The design of bolted or welded steel connections is presented in the "Manual of Steel Construction" (AISC, 1980).

Concrete joints or connections occur in several categories including those between precast members, between cast-in-place members, between precast and cast-in-place members, and between structural steel and both types of concrete. Joints may be made by welding steel reinforcement or structural steel inserts, by bolting, by pinning with dowels or key-type devices, by prestressing, and finally, with adhesives (ACI, 1977b). Encroachment of water into the joint is seen as the major cause of deterioration in concrete connections, so some method of sealing is required. Concrete joint design and sealing is addressed by the American Concrete Institute (1977a) and Noble (1964).

Joints or connections are often the areas of a structure most vulnerable to damage. This is especially true of dock, pier, and wharf structures in which a connection is afforded little protection. To be durable, a connection must resist both corrosion and fatigue failure by loosening. On the topic of corrosion, all light ferrous hardware should be hot-dipped galvanized (AWPI, 1975b). Contact of dissimilar metals must be avoided to minimize galvanic corrosion. Chaney (1961) recommends the use of wrought iron or malleable cast iron in place of steel. Finally, loosening of joints may be controlled by proper design initially, combined with good maintenance. Timber x-braces are a prime example. Instead of just a bolted joint that holds the brace

and pile in contact, a spike grid should be used inbetween. All bolts should be tightened during the early life of a structure to take up shrinkage and maintain full strength.

6.6 FIXED DOCK MOORAGE

Proper berthing of a small craft requires that the vessel be safely held in the slip without damage to itself or the structure. Mooring refers to the method of attachment of the boat to the dock. Fenders are provided to prevent damage resulting from hull to structure contact. While the primary task of the fendering system is to protect against impact on docking, it must be integrated into mooring design so that a vessel moored "alongside" is safe from abrasion.

Two types of mooring are currently used in recreational marinas: a stiff arm or strut system, and the traditional line mooring (Figure 6.24). Steel whips have been used to hold boats away from contact, as well as stern and bow clips. Dunham (1969) points out that while these systems work well initially, they become noisy with usage, and boarding may be difficult. Hull contact may also be avoided with line mooring systems if some provision is made to hold the craft away from the finger pier. The water level fluctuation that can be accommodated by fixed dock moorage systems depends on the length of the link between the dock and boat. Longer arms or tie lines allow greater height variations, but require more water area and larger berths.

Cleats are the most common method of attaching mooring lines between small craft and their berthing slips. Metal cleats of galvanized steel or noncorrosive alloy are available in several sizes from marina suppliers (Dunham and Finn, 1974). Some marina operators prefer wooden cleats

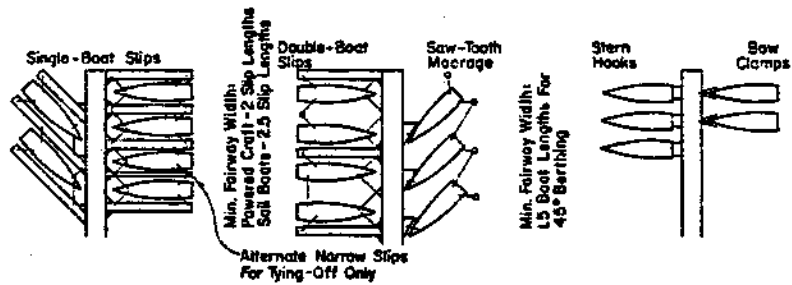

Figure 6.24 Small Craft Berthing Arrangements
(Dunham, 1969, p. 95)

(Figure 6.25), since they can be split to expose rusted bolts for repair. For small craft up to 40 ft (12 m), a 10 to 12 in. (250 to 300 mm) cleat is recommended. Since many cleat failures have been the result of pull-out under severe line stresses, Curry (1979) recommends that metal cleats be welded to a 1/4 x 3 x 6 x 12 in. (8 x 75 x 150 x 300 mm) angle that is then through bolted both vertically and horizontally to the dock. Lag bolts should not be used because they tend to loosen with stress and age.

While the ideal arrangement pattern will vary with each berthing system, Dunham and Finn (1974) suggest that one cleat fore and aft on either side of the vessel will be sufficient for boats up to 35 ft (11 m) long. The fore cleat should be mounted on the knee brace near the headwalk, while the aft cleat should be mounted near the end of the finger pier. Mooring systems for single and double-boat berths are illustrated in Figure 6.26. In the latter case, two cleats spaced 3 ft (0.9 m) apart on the edge of the headwalk replace the missing finger pier (Dunham and Finn, 1974). A tie-pile is also recommended as a substitute for the two outboard cleats of the finger, or a cooperative switch-tie system (Figure 6.27) may be used although this causes some inconvenience to the user.

Other methods of line attachment include rings, traveling irons and rails. Rings are used much like cleats but are less popular because they are somewhat noisy and because, unlike a cleat, the mooring line must be knotted. Traveling irons consist of hardware attached to the face of a dock that allows the point of fixity to move up and down with a moored boat as it rides the tide. Traveling irons are recommended by

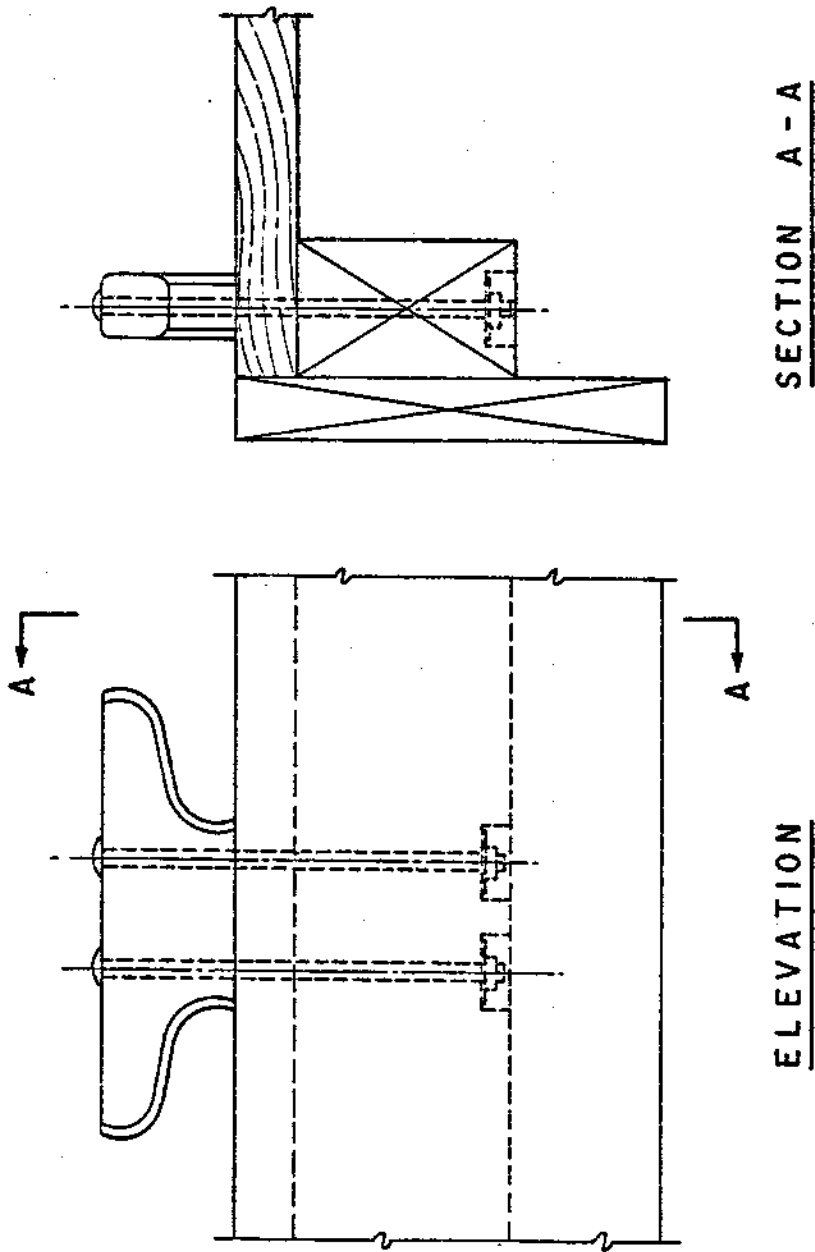
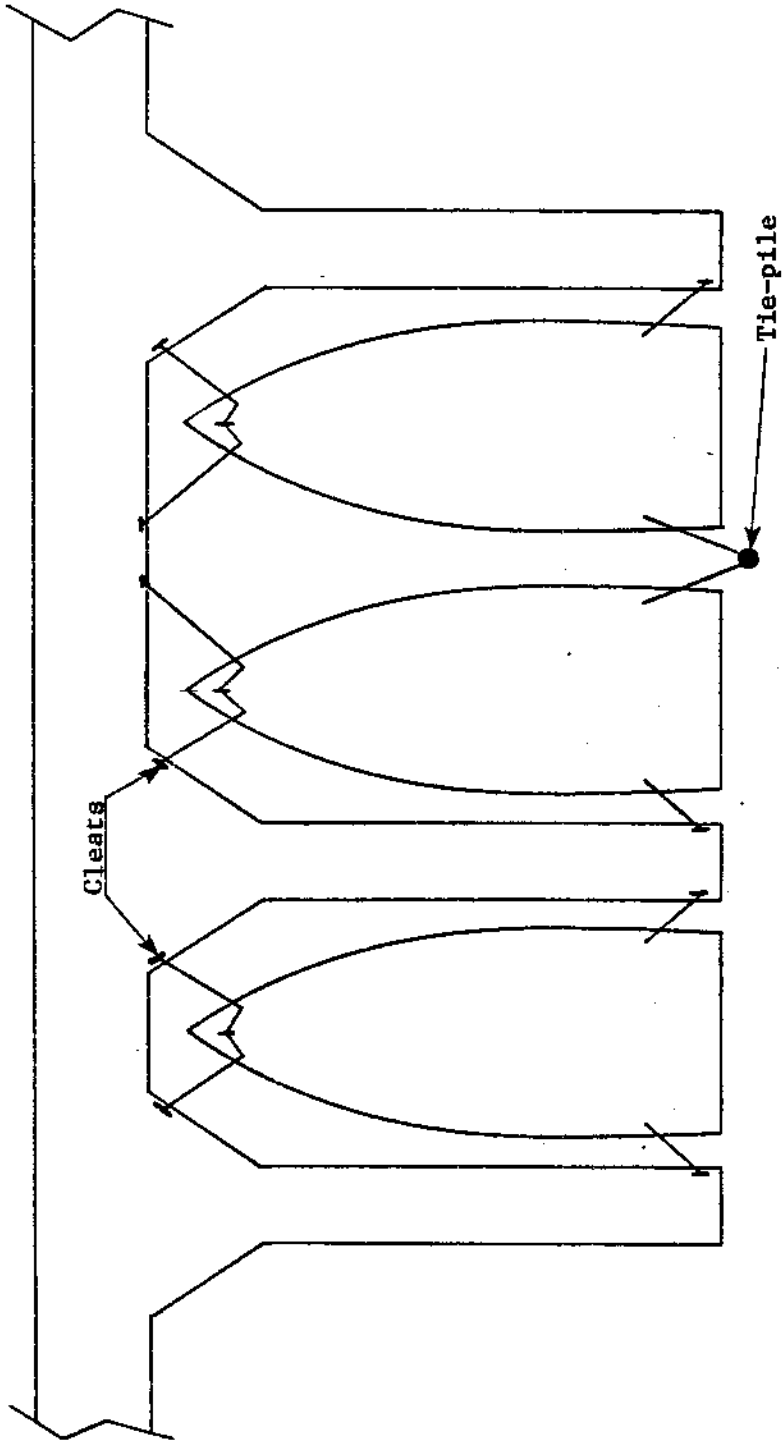

Figure 6.25 Hardwood Mooring Cleat (Dunham and Finn, 1974, p. 176)



A. Single Berth

B. Double Berth

Figure 6.26 Line Mooring and Cleat Location for Single and Double Berths

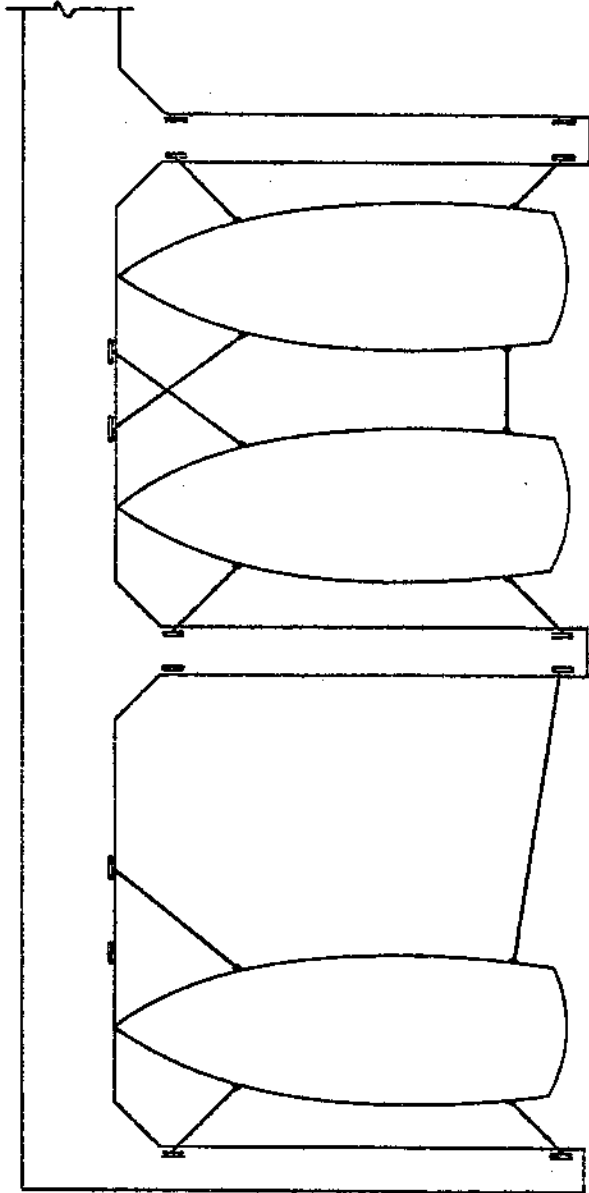

TIE SYSTEM WITH ONE BOAT DOCKED **TIE SYSTEM WITH BOTH BOATS DOCKED**

Figure 6.27 Cooperative Switch-Tie System for a Double Berth (Dunham and Finn, 1974, p. 111)

Chaney (1961) as a space-saving measure (Figure 6.28), and to eliminate the need to change line lengths of moored craft as the water level changes. Finally, Curry (1979) describes a "Bull rail" system installed along the main walkways of an Oregon commercial marina. These rails consist of 6 by 6 in. (150 by 150 mm) or 8 by 8 in. (200 by 200 mm) timbers set on 3 in. (75 mm) blocks on 4 to 6 ft (1.2 to 1.8 m) centers and bolted vertically with 5/8 in. (16 mm) bolts. A continuous rail system is especially suited to the fuel dock where mooring is temporary but large vessels must often be accommodated.

6.7 FIXED DOCK FENDERS

Fixed dock fendering systems are designed to absorb impact energy through controlled deflection of the fender material and dock structure. Fender design factors include vessel characteristics such as shape, mass, and speed; the approach direction; and the rigidity of the dock. While rubber, gravity, and floating fenders are all common to larger structures, wood rubbing strips are the standard for small craft fixed docks. Wood is an excellent material for such an application because of its low initial cost, resiliency, and ease of placement (Texas A & M University, 1971). Lasting performance should not be expected, however, unless properly treated, stress graded lumber is used with non-corrosive hardware. Furthermore, bolt hole diameter should be the same as the attachment bolts used so that no slack can develop in the system.

Fixed pier fendering commonly runs vertically rather than horizontally to accommodate water level changes. Wood rub strips are bolted to the dock face at 8 to 10 ft (2.5 to 3.0 m) intervals so that they bear on the rub nails or gunwale copings of small craft and hold them clear of

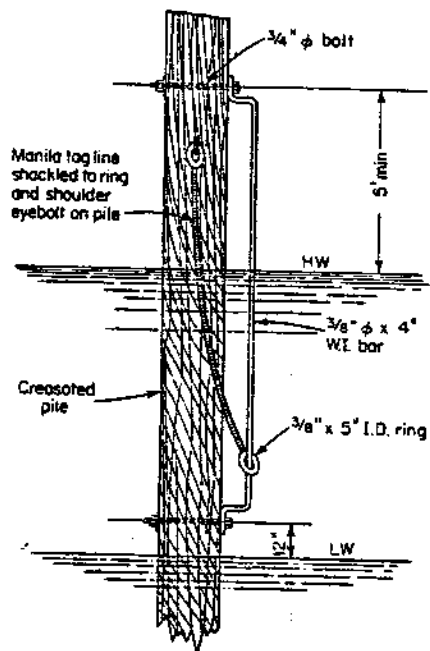

Figure 6.28 Traveling Iron
(Quinn, 1972,
p. 596)

the rest of the dock superstructure. Typical sizes range from 3 x 4 in. (75 x 100 mm) to 8 x 8 in. (200 x 200 mm) depending on the size of the vessel berthed (Dunham and Finn, 1974). Length depends on the magnitude of water level variations but, in general, the fender must extend higher than the highest gunwale at extreme high water, and lower than the lowest rubbing strake at extreme low water. While all dock face hardware must be countersunk or recessed to avoid damage to the boats (Chaney, 1961), it should be noted that this reduces the working section of the wood member somewhat. Fender and attachment design must account for this reduced strength as well as any moments induced by cantilever bending loads as the fender is struck at its extreme ends.

Other fixed pier fender systems include vertical plastic tubes, fender piles, and dolphins. Vertical plastic tube fenders (Figure 6.29) work much the same as wood rubbing strips but are more flexible and exert a milder impact on hulls (Dunham and Finn, 1974). They may be supported as shown in the figure or suspended from a top bracket with a heavy weight hanging below the lowest possible point of hull contact. Fender piles also function like rubbing strips but have a lower point of fixity somewhere below the mud line. As Figure 6.30 illustrates, fender piles are slender, flexible piles that are driven at a slight batter and attached to the deck superstructure. Fender piles are more expensive than rubbing strips, and their higher load capacity is not necessary for small craft berths. Dolphins are isolated marine structures that protect ships and docks from damage and aid in mooring. Dolphins usually consist of clusters of piles that are placed at the corners of docks to protect these easily damaged areas. The piles may be driven

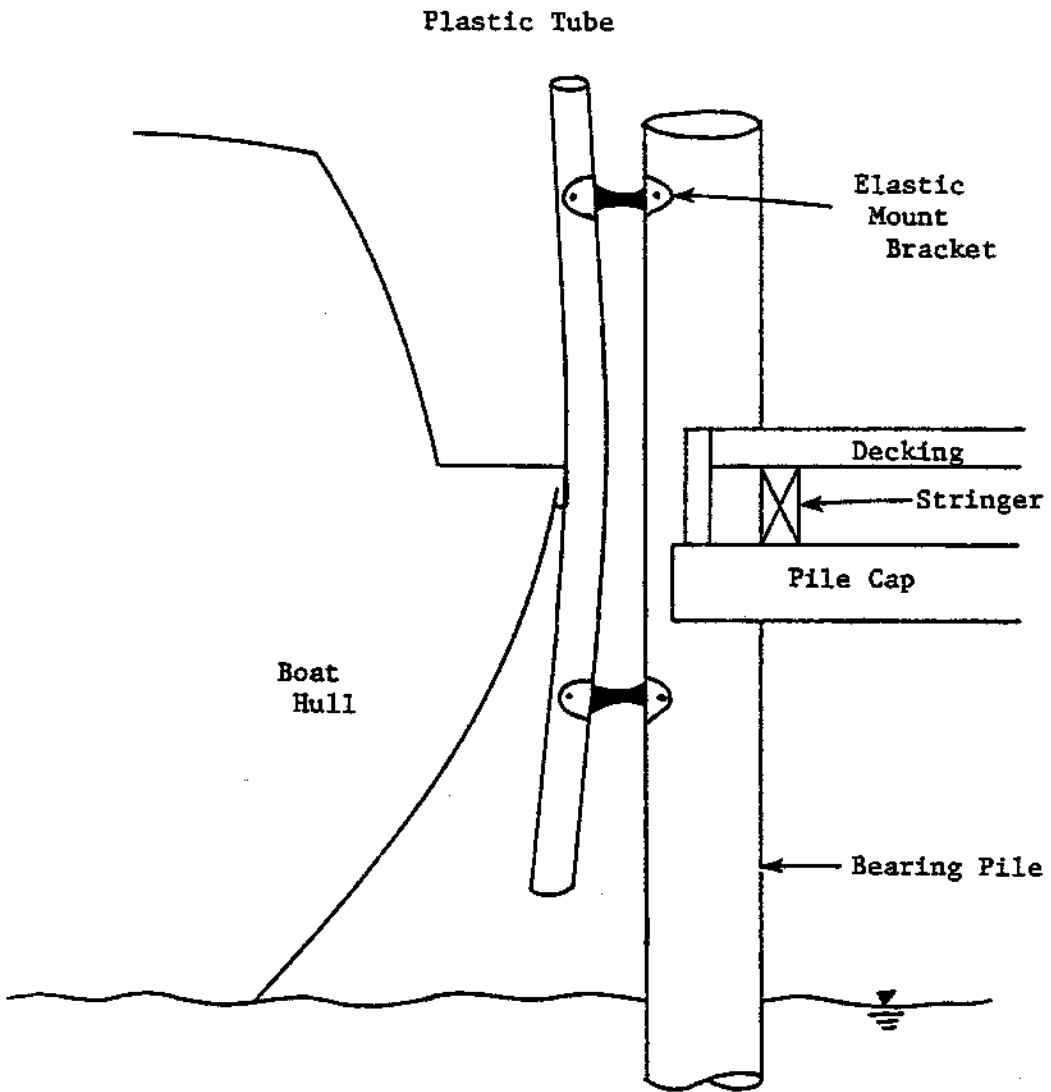

Figure 6.29 Vertical Tube Fender (Dunham and Finn, 1974, p. 181)

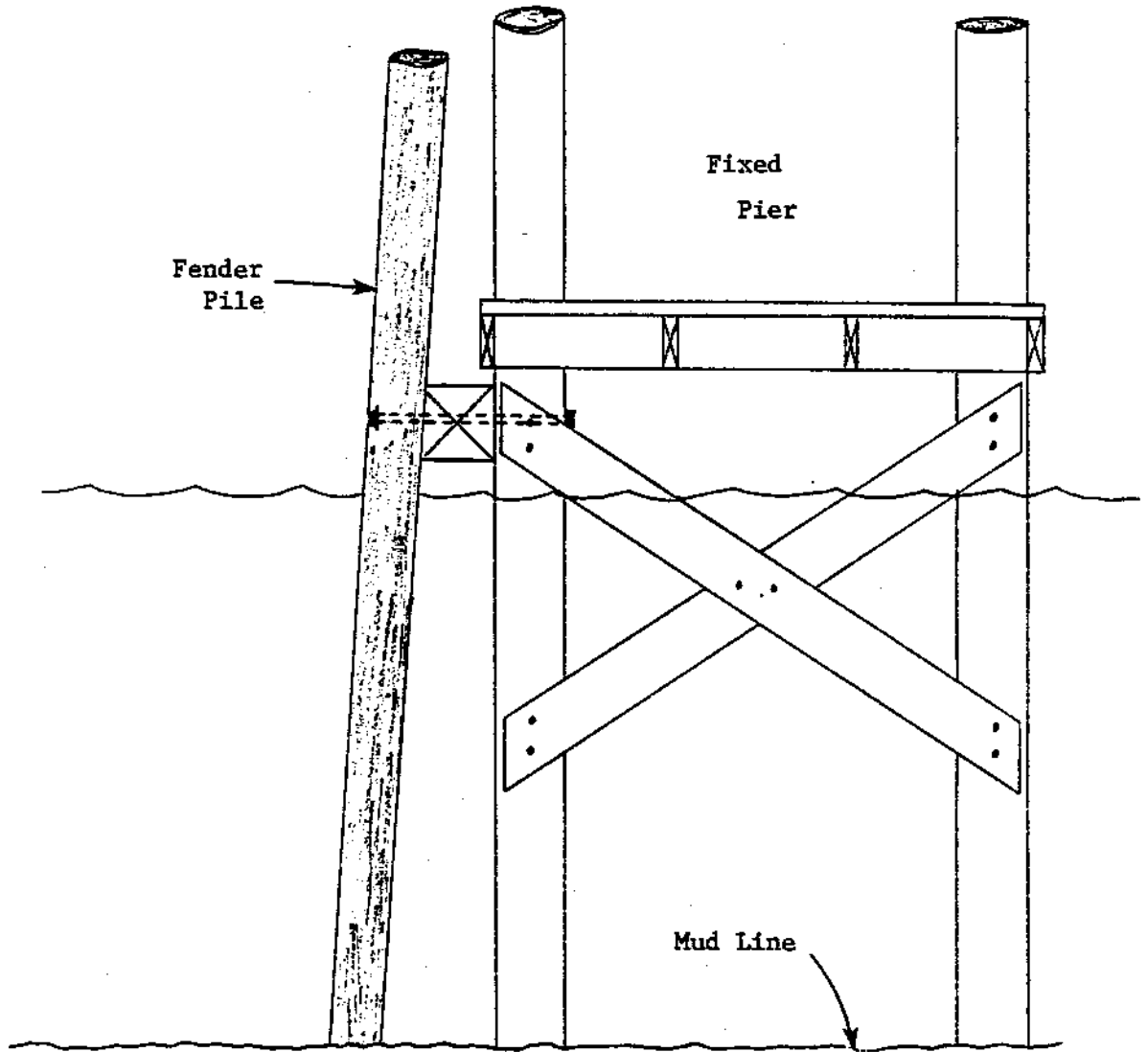

Figure 6.30 Vertical Fender Pile

to stand free, or be wrapped with several turns of steel cable (Figure 6.31) to work as a group.

6.8 SUMMARY

Fixed docks are supported by piles driven into the soil bottom of a marina basin. Fixed docks are best suited to locations where tidal variations are less than about 4 ft (1.2 m), total water depth is less than about 20 ft (6.0 m), and ice loads are not too severe. Fixed docks constructed in northern climates are usually provided with an air bubbler system to suppress the ice around the piles and minimize jacking and impact damage problems.

The most common pile type used in fixed dock construction is the pressure-treated timber pole. Other pile types include steel, concrete, and composite sections. The selection of pile type is based on availability, durability, strength, and estimated cost. Timber piles are generally the most readily available, the least expensive, and are durable if properly preserved. Steel piles are expensive to buy and transport, but can be spliced to any required length and can support very high capacity loads. Concrete piles include both cast-in-place piles and precast sections. Precast piles are more practical in the marina environment, but are very heavy and difficult to handle. Combination piles are not often used because of problems with the splice joint between the two materials.

The fixed dock superstructure consists of a pile cap connecting the piles of each "bent", stringers spanning between the bents, bracing to stiffen the framework, and a deck material laid over the top. A substantial portion of the cost of a fixed dock is spent on the pile

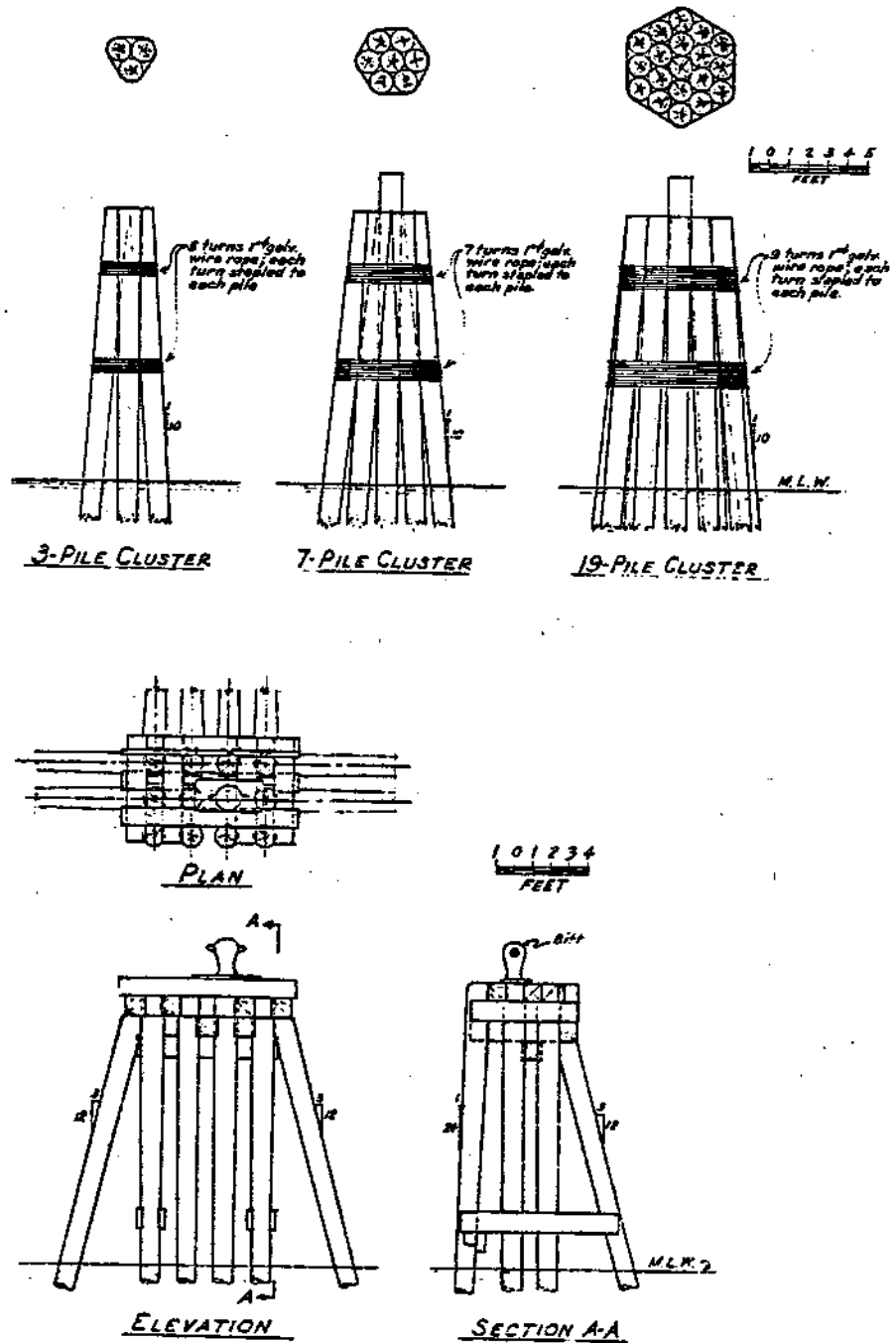

Figure 6.31 Typical Wood Pile Dolphins (Quinn, 1972, p. 432)

foundations. The overall pile costs can be reduced by using fewer pile bents, spaced at greater intervals, but this requires longer stringers. The practical maximum span depends on the material strength of the stringers and the standard sizes available. The decking is often timber planking which is placed diagonally for a lateral bracing effect. Fixed docks are designed as rigid frameworks and require tight connections. If the connections loosen because of fatigue, wood member shrinkage, or deterioration, artificial hinges can develop that quickly destroy the structural integrity of the system.

Fenders for fixed docks usually consist of vertical wood rub strips. The rub strip should be smooth faced so that the gunwale or rub rails of a berthed boat can slide up and down smoothly. Other types of fixed dock fenders include vertical plastic tubes, fender piles, and dolphins.

CHAPTER 7

FLOATING DOCKS, PIERS AND WHARVES

Floating docks, piers, or wharves are those that rely on their buoyancy for support. They are the major alternative to fixed or pile-supported structures intended for the berthing of small craft. While the application of either the "fixed" or "floating" type to a particular location depends on many site specific factors, floating slips are generally favored for water level variations greater than about 4 ft (1.2 m) and for basin depths greater than about 20 ft (6.1 m). Large water level changes are common on flood control lakes, rivers, and tidal inlets on the coast. Under such conditions secure mooring of a small craft to a fixed dock is difficult and boarding may be hazardous. Since pile costs are responsible for a large portion of the overall cost of a fixed dock, factors that increase pile costs such as great depths, very soft bottoms, or very hard (ledge rock) bottoms all favor floating berths.

Cost comparisons between fixed and floating docks, piers, and wharves are very risky in today's economy. Dunham (1969) notes that while fixed docks appear to be less expensive, there is an increasing trend toward the use of floating berths for all small craft harbors. In a later report, Chamberlain (1977) also finds the floating systems preferable while stating that costs are competitive between the two types.

In an effort to protect moored small craft better, floating and covered berths have been designed (Dunham, 1969). Two types are prevalent, differing in the method of supporting the roof. When the maximum water

level fluctuation is less than about 6 ft (1.8 m), the anchor piles of the float system may be extended up to support the top. In this type, pole shed construction is used that is identical to fixed-pier covered berths (See Chapter 6). The second type of floating-covered berth is suitable for water level variations in excess of 6 ft (1.8 m). Each floating pier is incorporated in a covered structural unit as illustrated in Figure 7.1. The superstructure consists of a continuous, truss-framed roof supported by columns from each side of the main walk and the outboard ends of the fingers. According to Dunham (1969), the superstructure is markedly different than a similar roof on land since it must provide structural rigidity for the entire float system that limits differential flexing to a small fraction of that which occurs in an open berth arrangement. Substantial bracing is required to achieve acceptable rigidity which leads to very large dead loads. The large above-water profile area causes high, wind-induced lateral loads that must be resisted by the anchorage system. Excepting very calm and protected waters, it is questionable whether floating covered berths are practical in light of their considerable cost for minimal benefits. As with fixed-covered berths, dry stack storage is suggested as an alternative (New York Sea Grant, 1978).

Floating dock, pier and wharf systems are well-suited to modular construction, and several manufacturers are marketing complete berthing systems. In general, their approach has been to develop float units that can be fastened together in various arrangements appropriate for different sites. The float unit usually consists of a number of pontoons attached to a framework that supports the deck. A mixture of plastic,

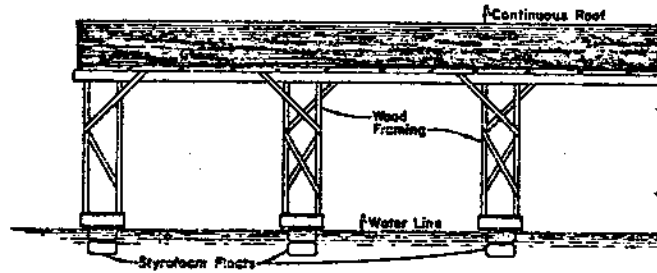

(a) FRONT ELEVATION

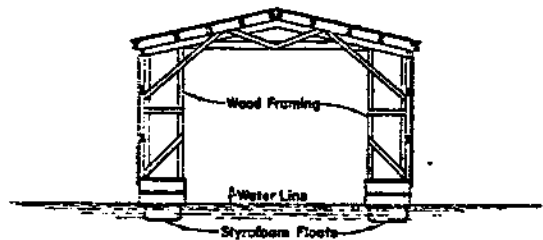

(b) FRONT ELEVATION

Figure 7.1 Floating Covered Berths
(Dunham, 1969, p. 112)

timber, steel, aluminum, and concrete materials is common for a well-designed system.

This chapter begins with a discussion of structural geometry of floating docks, piers, and wharves. Next, foam flotation is addressed, followed by the various types of pontoons differentiated by shell material. The selection of float type and design considerations for floating docks concludes this second section. Anchoring systems comprise the third section, including control piles, pile yokes, pipe struts, and cable anchors. The final section consists of the design considerations concerned with decking and framing for floating docks, piers, and wharves.

7.1 STRUCTURAL GEOMETRY

The structural geometry of floating docks, piers, and wharves is in a sense similar to the fixed structures described in Chapter 6. Vertical support is provided by flotation elements or pontoons which replace the pile bents and are arranged under a deck superstructure which acts to distribute the deck loads. The pontoons are most often rectangular (parallelepipeds or cylinders and may be placed transversely or longitudinally under the superstructure (PIANC, 1976). If placed transversely, the pontoon should be as long as the dock is wide to ensure maximum transverse stability. Stability is also a major concern when the longitudinal arrangement is used. Chaney (1961) notes that stability is maximized by concentrating the flotation elements under the edges of the dock, even for asymmetrical loading.

The deck superstructure of a floating dock or pier usually consists of a set of stringers that supports a deck that rides 15 to 20 in (380 to 510 mm) above the water with no live load (Figure 7.2). Other structural

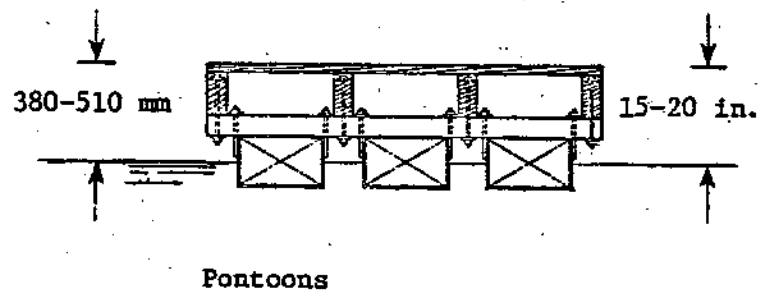

Figure 7.2 Floating Dock Indicating Suggested Freeboard
(Ayers and Stokes, 1976, p. 37)

types include a metal truss system supporting the deck, a glued-laminated marina plank, or a concrete deck that is monolithic with the floats below (Figure 7.3). Along the perimeter of most of these systems lies a heavy timber rub rail or waler.

Short float sections or modules are generally assembled on shore, launched, and then connected end to end to form the berthing system. The main walkways of the piers extend outward from fixed or floating marginal wharves. Small craft are berthed at finger floats attached at right angles to the pier. Nonorthogonal connections in finger float and walkway alignment should be avoided since they are subject to stress concentrations that cause damage and increased maintenance (Curry, 1979). Knee braces are commonly provided at the finger float/main walk junction. The knee brace area is a good location for anchor piles, locker boxes, and utility risers. Access to the float system is gained by means of hinged gangways that slide along the deck as it rises and falls with changes in water level. Anchorages in the form of guide pile or cable systems are used to restrain floating berths against lateral loads.

7.2 DESIGN CONSIDERATIONS FOR FLOTATION ELEMENTS

According to Dunham (1969), the earliest known flotation is the ordinary timber log. While logs are very economical on a first cost basis, they have two main disadvantages. First, they tend to become saturated with time and will sink after a few years. Secondly, they are susceptible to marine borers and, if treated against biological attack, they retain little of their original buoyancy. Except in unusual circumstances, wood is not recommended as a flotation material. A suitable replacement should be inexpensive, light, and impermeable to water.

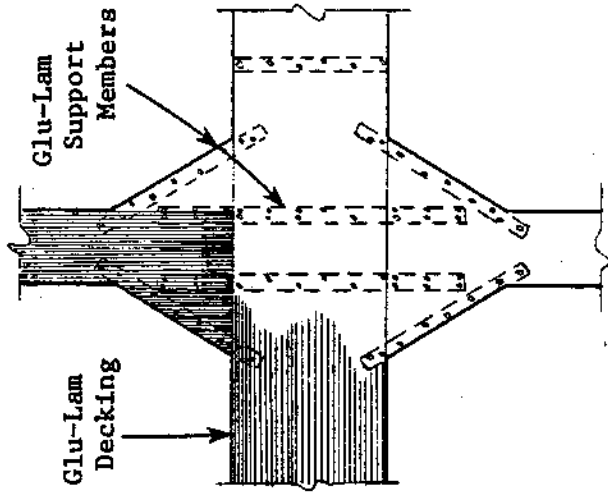

B. Glued-Laminated Marina Plank

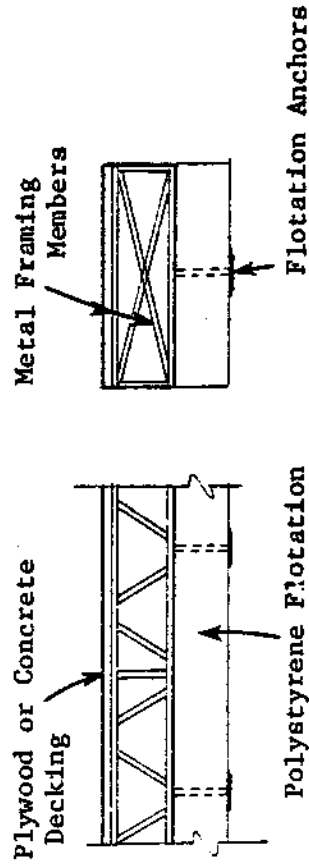

A. Metal Truss System

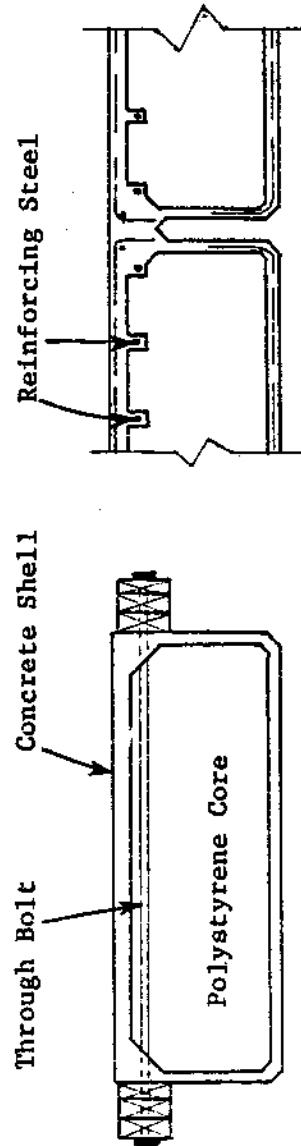

C. Monolithic Concrete

Figure 7.3 Floating Dock Structural Types (After Winzler and Kelly, 1979, V-5, V-32, VI-4)

To be durable in the marine environment, it should also be resistant to petroleum products, easily fastened to the deck structure, flame retardant, and resistant to ice damage in cold climates (Koelbel, 1979). Satisfactory float types include lightweight solids, hollow shells, or combinations of these. Several types of closed-cell foams qualify as acceptable lightweight solids. While there are many types of hollow shells that could be used as flotation devices, most are now being replaced with foam-filled shells (Dunham and Finn, 1974). Problems with leakage, internal condensation of moisture, impact damage and vandalism are largely responsible for the change. Combinations of shells and foam cores are therefore the primary float type to be addressed.

Foam Flotation

The most "successful" of the foam flotation materials include extruded polystyrene, expanded-pellet polystyrene, and foamed polyurethane (Dunham and Finn, 1974). While foam blocks have been used successfully as flotation elements without any surface coating, they suffer from a lack of durability. One of the worst problems is somewhat indirect. Large quantities of marine growth rapidly accumulate on unprotected foam floats. The plant matter attracts small organisms which in turn attract birds and sea animals to feed. It has been reported that large pieces of foam have been torn out as these animals seek marine life burrowed into the underside of the foam surface (Dunham and Finn, 1974). In addition, some foams are susceptible to damage from petroleum or ice contact, and may be flammable. For these reasons, some form of external protection is now applied to all foam floats, especially in saltwater. Protection may be in the form of a brushed-on coating or a more substantial

shell of plastic, fiberglass, metal, or concrete.

There are two basic approaches to manufacturing foam filled pontoons. The first method is to use a block of foam as the internal form and construct the shell around it. The alternative is to finish the shell first and foam the core material in afterward. Extruded polystyrene (commonly called styrofoam) in the form of planks is most suitable for the internal form construction because of its low cost and uniform quality, and because it is completely impervious to water (Dunham and Finn, 1974). While the expanded-pellet polystyrene may be less expensive than styrofoam, it is subject to quality control problems. Overexpansion of the beads or non-uniform heating will produce a low quality friable foam that is permeable to water. Since polystyrene is a common flotation material, the following specification recommended by the California Department of Navigation and Ocean Development (State of California, 1971) is reproduced for potential buyers:

"(1) Materials: Cellular polystyrene may be formed by the expansion of high density beads or granules in a mold or directly from the base resin by extrusion. The material shall be firm in composition and essentially unicellular. No reprocessed materials shall be used.

(2) Dimensions: Unless otherwise specified, the manufacturers' standard size will be acceptable if incorporated into the design with a minimum of field cutting. The tolerance in each dimension shall be plus 1 inch or minus 0.5 inch.

(3) Color: As normally supplied by the manufacturers for the particular type of polystyrene. Variation in color indicative of damage or deterioration will not be accepted.

(4) Surface Finish: Surface shall be stressed, polished, free from pits, blisters, cracks, dents, waviness, heat marks, or deep scratches.

(5) Odor: The material shall be free from any objectionable odor.

(6) Exterior Coating: In all locations where the waterfront is subject to infestation by marine borers which damage polystyrene, the flotation material shall be protected with an adequate material capable of resisting any anticipated attack by marine organisms.

(7) Physical Properties: Specimens from polystyrene planks shall conform to the requirements stated below:

- (a) Density: 1.5 pounds per cubic foot (minimum).
- (b) Compressive Strength: 20 pounds per cubic inch minimum at 5 percent deflection.
- (c) Tensile Strength: 40 pounds per square inch minimum at break.
- (d) Shear Strength: 25 pounds per square inch minimum at break.

(8) Moisture Absorption: The maximum water absorption shall be 0.12 pounds per square foot of skinless or rindless surface when tested by immersion method in accordance with U.S. Department of Defense, Military Specifications Mil-P-40619 (3 April 1962) 4.5.7.

(9) Hydrocarbon Resistance: Polystyrene planks to be used in the vicinity of gas docks or other areas subject to petroleum products floating on water shall be hydrocarbon resistant. The materials shall show no apparent softening or swelling when tested by the immersion method specified in the U.S. Department of Defense, Military Specifications MIL-P-40619 (3 April 1962) 4.5.10.

(10) Shape: Surfaces of the finished planks shall lie in normal planes so that the plank, when installed in final position in the floating dock, shall lie in a true horizontal plane with the water. Edges formed by molding or cut sections may be either rounded or square."

Polyurethane is often preferred over polystyrene when the foam is to be placed inside a finished shell. Of the two types of polyurethane available, only the monocellular variety is non-absorbent and should always be specified (Dunham and Finn, 1974). While polyurethane foams are naturally resistant to hydrocarbons, they are prone to oxidation and should be provided with a protective covering.

One final note regarding foam flotation has to do with polymer compatibility. Some coatings or adhesives will work well with one foam

but react with another. According to Dunham and Finn (1974), polyester resins are compatible with polyurethane but not with polystyrene. Most manufacturers have representatives available for technical advice should such a question arise with the use of their product.

Coated Lightweight Pontoons

Lightweight shell pontoons are those in which the coating is a form of protection only and does not add significant strength to the foam core. Common protective coverings include brush or spray coats of polyvinyl-acetate emulsion or dense polyurethane (Dunham and Finn, 1974), epoxy paint (Dunham, 1969), and fiberglass reinforced polyester (PIANC, 1976). These coatings all bond to the foam core and provide a tough flexible skin that attracts less marine life and is easily wiped off. Compatibility between the coating and core should be checked to ensure the two materials do not react. For example, if the protection of a fiberglass and resin shell is desired over a polystyrene foam core, an intermediate coating of epoxy that is compatible with the resin must first be applied (Dunham and Finn, 1974).

Concrete has also been used as a coating for light, foam core floats. Although it adds considerable weight which must be compensated for with more flotation material, concrete provides an armored surface that may prolong the life of the system (Dunham, 1969). Concrete coated floats are stable because of their increased mass, and are quite durable as long as they are protected from impact damage. Noble (1964) cites the use of a polystyrene pontoon coated with 3/8 in. (10 mm) of concrete troweled in place. PIANC (1976) recommends a coat of fiber reinforced

concrete about 3/4 in. (20 mm) thick. Shotcrete has also been used with some success as a coating material. These pontoons are similar in appearance to the concrete shell type but float much higher.

Synthetic Molded Shells

The most common molded synthetic shells are made of fiberglass-reinforced polyester resin or high density polyethylene. Material technology in the field of synthetics is rapidly evolving, however, and other shell materials that are equally acceptable may be available. An attempt should be made by potential users of these materials to investigate their service record with respect to durability.

Fiberglass and polyethylene shells tend to be more durable than the lightweight shells mentioned above because of their better quality and increased strength. Brushed or sprayed-on coatings are typically non-uniform in thickness and contain local defects such as air bubbles or contaminants. This leads to cracking, pinhole leaks, and general slow deterioration (Dunham, 1969). The fiberglass and polyethylene shells on the other hand, are pressure molded between matched dies to ensure uniform wall thicknesses. Controlled manufacturing and curing conditions eliminate the defects experienced with lightweight shells.

As pontoon materials, fiberglass and polyethylene have many other advantages that are attractive to the marina designer and owner. Floats made of these materials are non-corrosive, non-conductive, resist marine life build-up, are not affected by petroleum spills, and have excellent impact strengths. In addition, one piece seamless construction is possible with provision for easy attachment to the deck framing.

Steel or Aluminum Shells

Metal shelled floats of steel or aluminum are another alternative for floating dock pontoons. Two shapes are common including a rectangular unit of folded thin gauge metal sheet with stiffener baffles, or a tubular one with end caps that resembles a corrugated drainage pipe. Used steel oil drums have been used as flotation units but should be considered only for short term or temporary projects because of their poor durability (Dunham, 1969). While fabricated steel and aluminum floats are also subject to rapid corrosion, they are commonly protected by manufacturer-applied preservative coatings both inside and out. In spite of this coating, most metals are not recommended for use on the sea coast because of their high corrosion rate in the saltwater environment (Dunham, 1969). Corrosion resistant alloys are available at some extra cost that may overcome this objection. Metal floats are nearly all foam-filled to provide extra protection against leakage, internal condensation, and internal corrosion (Dunham and Finn, 1974). Metal pontoons are particularly serviceable where ice formation and heavy floating debris is encountered.

Concrete Shells

Concrete has proven to be an excellent material for marina pontoons (Noble, 1964). Several manufacturers market floats with lightweight concrete shells around foam cores. The concrete usually used has a density of 100 to 110 pcf (15.7 to 17.3 kN/m^3) significantly less than the 145 pcf (22.8 kN/m^3) density of normal concrete (Curry, 1979). The primary advantage of lightweight concrete is that less buoyancy is required to support its dead weight. Pontoons of normal concrete

also require larger handling equipment and the resulting handling stresses are more critical because of increased size and weight (Noble, 1964).

Concrete floating dock systems are often cited for their stability and durability (Noble, 1964; Dunham, 1969). The heavier the pontoon, the greater its stability, providing the center of gravity remains low. Concrete pontoons tend to be more massive than other float systems and do not respond as quickly to load impulses or small waves. The mass of a concrete float system may work against it, however, in areas subject to long period waves or harbor surge (Curry, 1979). Considerable damage has been noted at locations where surge ran 10 to 18 in. (250 to 450 mm) at periods of 1 to 5 minutes. While concrete is very durable in the marina environment, it has three main weaknesses. First, reinforcement corrosion has led to deterioration of the walls of concrete shells. Since these must be thin-wall structures, it is difficult for the manufacturer to keep the reinforcing mesh in place at the center of the concrete section. For this reason, many designers do not use any reinforcement but instead design the float so that at no point will the tensile strength of the concrete be exceeded (Dunham, 1969). Second, concrete borers of the pholad family may damage concrete pontoons. Resistance to pholads depends on the quality and dispersion of the aggregate. Noble (1964) notes that ordinary rock and expanded shale aggregate have resisted attack while perlite aggregate, shotcrete without coarse aggregate, and plaster concrete coatings can be bored in 3 to 4 years. Finally, concrete pontoons are very susceptible to poor quality control and poor installation practices (Curry, 1979). Care must be taken during construction to use the proper quantity and quality of

foam core material, to locate the core correctly in the form, and to vibrate and finish the concrete shell properly. These steps will ensure that the floats are balanced and uniform, with walls, bottoms, and decks of the proper thickness and concrete quality. The best designed floats of the finest quality will still not function properly if poor installation procedures are used. Rough handling during transportation and launching will induce bending and impact stresses that lead to broken corners, cracks, and holes (Dunham, 1969). Rapid temperature changes and improperly tightened connections may also cause cracking.

7.3 SELECTION OF FLOAT ELEMENT TYPES

Of the decisions that must be made by the designer of a floating dock, pier, or wharf, the choice of flotation material may be the most controversial (Dunham, 1969). In some cases, the proper judgment is obvious. Logs, unprotected foam billets, and waste oil drums are acceptable only as temporary or short term float materials. On the other hand, the selection of a particular type of foam-filled shell may be based largely on the preference of the marina operator or patrons. Availability, durability, stability, and life cycle costs are factors to be considered in selecting a float type for a given marina installation. As in the case of fixed docks, piers, or wharves, appearance may also be an important criterion but will not be addressed here.

Pile foundations such as those used for fixed docks, piers, and wharves are also used to support other structures located on soft ground. For this reason, the various types of piles addressed in Chapter 6 are generally available regardless of location. Floats, on the other

hand, are not as readily available because of their narrower scope of application. The marina designer must first determine which float types may be obtained, followed by probable shipment and handling problems. In general, flotation elements are light and bulky, so all may be transported by land carriers. Lightweight and synthetic shell pontoons are easily handled manually while metal and concrete shell pontoons are heavy enough to require light machinery.

Durability is not a problem with any of the established float materials as long as they are used within their limitations. Lightweight shells are most suitable to calm, protected harbors where they will not be subjected to a lot of abrasion or impact. Metal shells, regardless of the coating applied, should not be used in saltwater because of their potential for corrosion. Care must be taken during the construction and launching of concrete shells to avoid tensile cracks that will lead to deterioration later on. The materials industry, especially in the field of synthetics, is rapidly evolving and has produced many new materials with potential application to float construction. The designer should be cautious in the use of these products, however, as they lack reliable data on fatigue, weathering, and wearing qualities (Dunham, 1969).

When used to describe a floating dock, pier, or wharf system, the term "stability" refers to how steady the structure feels underfoot. For a given deck superstructure, heavier floats will feel more stable to the user. Massive float systems do not respond as quickly to wave chop or dynamic live loads. Lightweight floats, however, tend to feel bouncy in the same conditions. The opposite is true in locations sub-

ject to long period (1 to 5 minute) surge, according to Curry (1979), where concrete float systems have experienced considerable damage.

Life cycle costs should also be considered when selecting flotation elements for a floating dock, pier, or wharf. Life cycle costs include both the initial installation cost and maintenance costs over a standard design life. Generally, lighter, less substantial floats will be less expensive to purchase, but will require more maintenance. Heavier, more durable floats may be preferable from an operators standpoint since they minimize downtime during which maintenance is performed.

7.4 DESIGN CONSIDERATIONS FOR FLOAT COMPONENTS

The design of a floating structure is very complex, particularly the connections between the float modules. Unlike a fixed structure, the vertical support is not uniform and varies continuously with changes in water level and deck loading. The deck and framing system must be flexible enough to conform to the water surface while at the same time having sufficient rigidity to distribute loads without the local overstressing that leads to the development of an artificial hinge. This tradeoff is a difficult one and, according to Chamberlain (1978), the design of such systems is not safely left to amateurs. Two alternatives are available to the designer of a floating dock. First, a number of manufacturers are marketing float systems, some of which have many years of performance records that show them to be successful. Second, an expert with experience in the design of similar facilities may be consulted. While it is difficult to equate the two approaches in terms of cost, the prefabricated docks may be less expensive because of volume production and lower design costs. Unfortunately, they

also more difficult to adjust to site specific conditions or owner preference.

The basic building block of a floating dock, pier or wharf is the float unit or pontoon. These pontoons are assembled with some members of the framing system on shore, launched, and then connected end-to-end to form the main walkways and finger floats of a berthing system. A floating dock consists of pontoons, stringers or walers, a deck, and bracing to make it sufficiently rigid. The following discussion presents the design considerations concerning each of these components as well as the connection and fastening details necessary to assemble the float system.

Pontoons

The first item in the design of pontoons is to determine their size and number required and how many pontoons are required for each module. According to the principles of buoyancy, an individual pontoon will support a total vertical load equal to the weight of water displaced when it is fully submerged. The vertical load as defined in Chapter 3 is the sum of the dead and live loads. The weight of the pontoons supporting a float module must be included in the dead load along with the weight of the stringers, walers, decking, and hardware. It follows that for the same live load capacity, concrete shelled pontoons must be larger than lightweight units. Manufacturers of commercial flotation elements produce standard sizes that have been found to be suitable for a range of deck and framing designs. The designer of a float module chooses a particular pontoon and determines the number required per module by dividing the total vertical load by the load capacity per pontoon.

Some floating docks are designed with continuous, shallow pontoons along their length, while others use a few large pontoons placed at strategic locations for stability. Dunham and Finn (1974) note that systems with continuous flotation elements will tend to trap surface debris, since no gaps exist for skimming or circulation. The use of large, discrete pontoons allows surface currents to flush debris through the gaps and results in a cleaner marina.

The attachment of the pontoons to the deck superstructure is another very important aspect of floating dock design. Attachment refers to the location of the pontoon within the framing members, as well as the methods of affixing the pontoon to these members. Figure 7.4 illustrates three different dock profiles to demonstrate the effect of pontoon placement on dock design. With respect to Figure 7.4, some definitions are in order. The distance labeled "dead load" is the depth to which the float system sinks without any live load acting on it. The "live load capacity" height remaining from the water line to the top of the pontoon when the dock is floating under its dead load only. This height corresponds to the amount of live load the dock can support just before the floats submerge and the whole dock begins to sink. Most floating docks have some height above the live load capacity line as indicated in Figure 7.4 which is defined as the "freeboard remaining with no live load capacity". Dock profiles (a) and (b) cause a false sense of security as the live load capacity is used up long before the deck reaches the water level. Koelbel (1979) cites several cases of boat shows where eager patrons crowded the docks until the pontoons became entirely submerged (with 6 to 8 in. or 152 to 203 mm freeboard remaining) followed by immediate submergence of the entire pier. Dock profile (c), on the

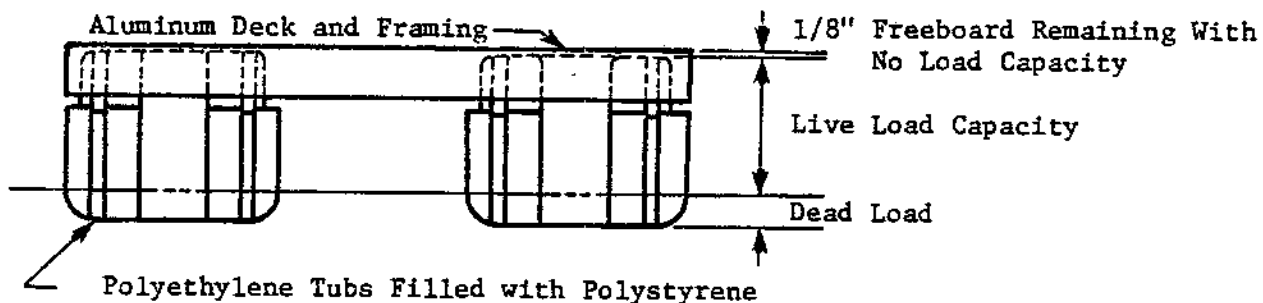
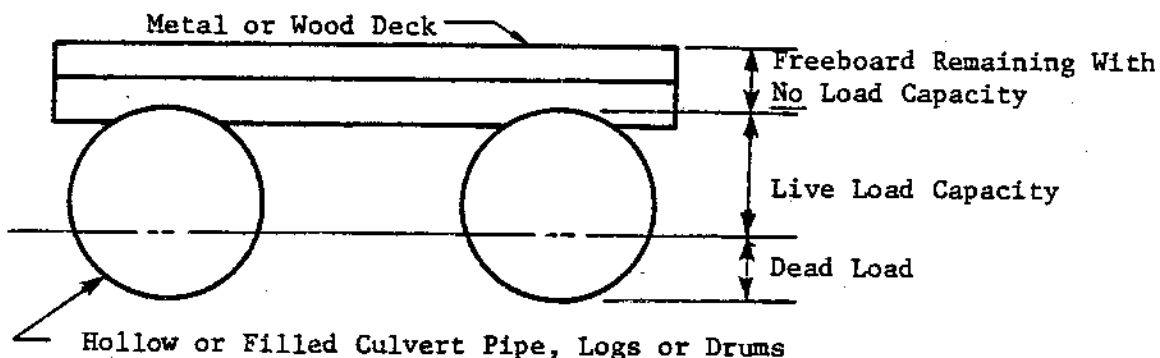
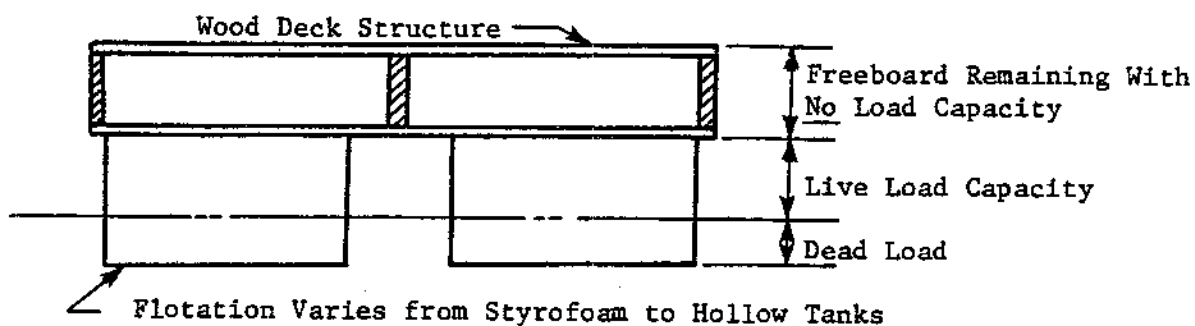

Figure 7.4 Floating Dock Design for Pontoon Location
(Koelbel, 1979, p. 17)

other hand, provides increasing live load capacity to the point where the freeboard is virtually zero. The point to be made here is that freeboard is not a reliable indicator of live load capacity. A float design that minimizes the distance between the top of the pontoon and the deck surface is to be preferred for reasons of safety.

The height at which the deck of a floating dock rides above the water should be suited to the sizes and types of boats to be berthed. Dunham and Finn (1974) suggest that a range of 15 to 20 in. (380 to 508 mm) is appropriate for small craft docks floating under dead loading only. Koelbel (1979) recommends a freeboard of 18 in (460 mm) for the same condition. Some agencies also require that the dock settle no more than 8 to 9 in. (203 to 229 mm) under full live loading (Dunham and Finn, 1974).

Methods of affixing pontoons to the framing members of floating docks vary according to the float material. Unprotected foam blocks or lightweight shell pontoons do not have sufficient bending strength and must therefore bear on a flat surface under the deck superstructure (Figure 7.5). Bearing boards are attached to the bottom of the stringers and contact the top of the foam or lightweight floats. Contact pressures of about 5 psi (34.5 kN/m^2) are acceptable for most foams, but the bearing boards should not be spaced more than 2 ft (0.61 m) apart and should be continuous along each edge (Dunham and Finn, 1974). The floats are then attached to the bearing board with skewed hardwood dowels driven into the foam, or nylon strapping that goes around the float. The strap method is preferable because repair or replacement of the floats is much easier.

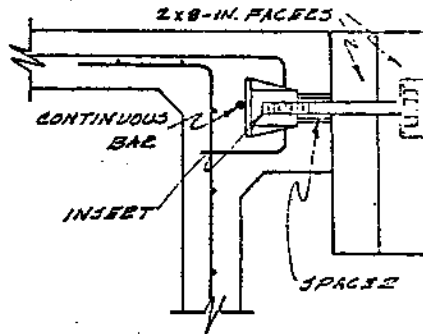

Figure 7.5 Timber Frame and Bearing Boards above Premolded Styrofoam Floats
(Chaney, 1961, p. 139)

Pontoons with stiffer shells of molded plastic, steel, aluminum or concrete have adequate strength to be bolted to the framing members of the deck superstructure. Molded shells usually have an integral tab that is provided for bolting while the metal pontoons can have brackets attached by welding. The most difficult attachment occurs for lightweight concrete shells since care must be taken to avoid tensile stresses that will cause cracking. Two basic methods are used to bolt up concrete pontoons to wood walers: inserts or through-bolts (Curry, 1979). Figure 7.6 illustrates both insert and through-bolt concrete pontoon assemblies. Curry (1979) recommends the use of through bolts since insert assemblies can be stripped or even pulled out of the concrete. Through bolts however are easily replaced if stripped or otherwise damaged.

Stringers and Walers

The stringers and walers of a float system form the framework that holds the deck together above its supporting floats. Walers are a special type of stringer in that they are visible on the face of the dock and can also function as rub rails. Depending on the rigidity of the connection between the finger floats and main walk, the stringers and walers in this area are subject to severe vertical bending stresses induced by wave action. Assuming a harbor depth of 10 ft (3.0 m), a design wave height of 2 ft (6.1 m), and a wave period of 5 seconds, a typical local wind wave will be about 80 ft (24.4 m) long from crest to crest (Dunham and Finn, 1974). Taking a wave approach along the axis of the mainwalk to be the worst case, the deck structure is loaded in bending with support points nearly (80 ft or 24.4 m) apart. Ordinary stringer systems supporting only the deadweight of the deck and floats cannot



—Detail of facer attachment of a patented system

A. Insert Assembly (ACI, 1964, p. 111)

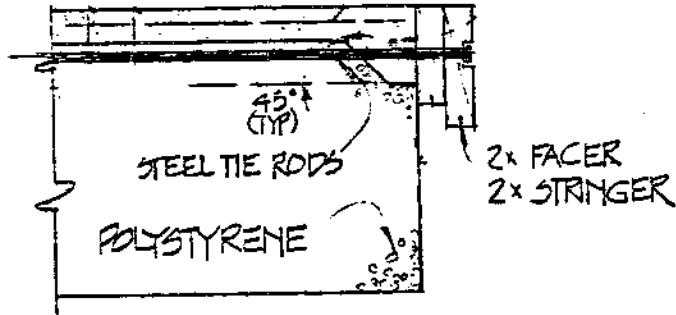

B. Through-Rod Assembly (Winzler and Kelly, 1979, p. V-30)

Figure 7.6 Insert and Through-Rod Concrete Pontoon Assemblies

span such a distance, however, and Dunham and Finn (1974) note that resultant deflections will be about 1.5 ft (0.46 m) vertical in 45 ft (13.7 m) horizontal. Properly designed timber stringer systems can accommodate these deflections in flexure given adequate splice joints. If the joints are weak or allowed to loosen, the structure will form an artificial hinge at that point which leads to a rapid deterioration of structural integrity and major repairs.

Assuming the conditions mentioned above, a stringer system consisting of a 2 by 6 in. (51 by 152 mm) plank inside with a 2 by 8 in. (51 by 203 mm) plank outside, as shown in Figure 7.7, would be adequate for a 4 ft (1.2 m) wide finger float on lightweight shells (Dunham, 1969). Waler thickness is usually increased to a 3 or 4 in. (76 or 102 mm) nominal thickness to allow countersinking of the attaching hardware without reducing strength (Chaney, 1961). The thicker members are also found to be superior from a wood quality standpoint, with fewer checks and structural deficiencies (Curry, 1979). Dunham (1969) notes that stringer design based on the vertical stress criteria will normally be adequate for horizontal stresses, provided that adequate cross and knee bracing is installed. Another important consideration in the sizing of walers is the level of contact with the berthed craft. Walers should extend down to 8 in. (203 mm) above the water when the dock is subjected to a dead load only so that boats with low rub stakes will not be caught underneath (Dunham and Finn, 1974). At the same time, vertical fender posts may be necessary for boats with high gunwales. Floating dock fendering is addressed in more detail in a subsequent section of this chapter.

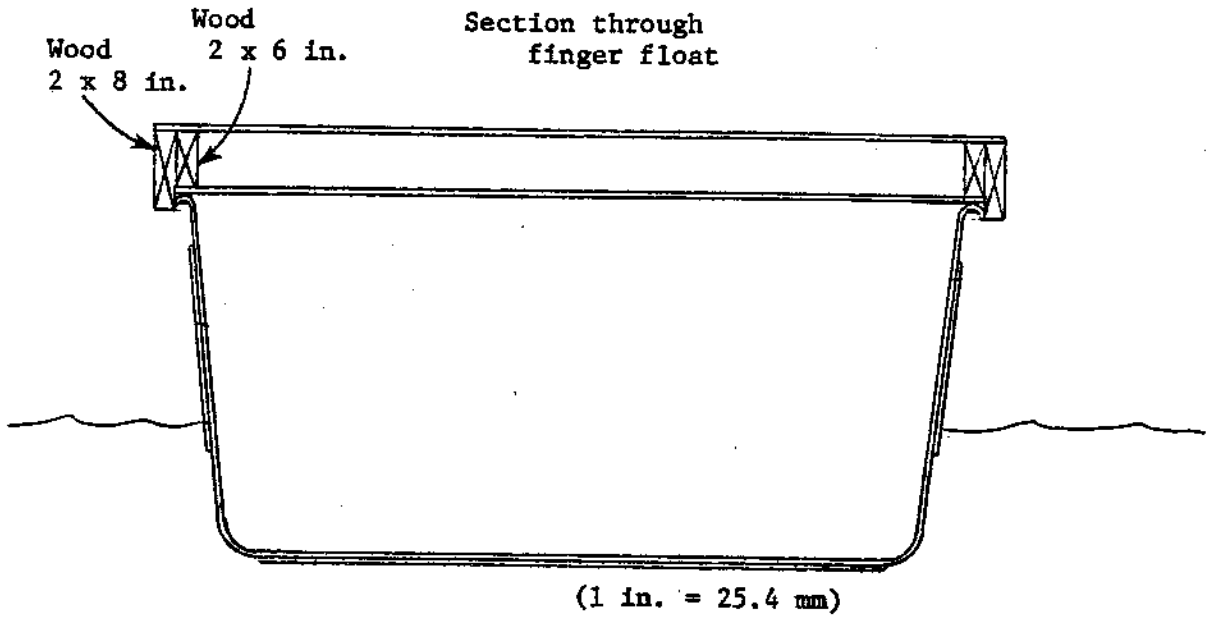

Figure 7.7 Stringer Detail on a Lightweight Shell

While timber stringers are the most common, lightweight metal truss systems have also been used (Figure 7.3). Since these proprietary systems are prefabricated and interconnected entirely by bolting, they may be rapidly installed, and easily expanded to create more berths. They are only suitable to rather calm, freshwater locations, however, according to Dunham and Finn (1974) since overstress and corrosion problems are likely.

Bracing for Floating Docks, Piers, and Wharves

Braces are required in a floating berthing system primarily to transmit lateral loads into the anchorage points spaced throughout the installation. They also provide the structural integrity and sense of rigidity that Chamberlain (1977) claims is so important to a successful marina. The most obvious brace type is the knee brace located at the finger float/main walkway junction of most floating facilities. Other brace types include internal x braces, struts, and torque pipes.

Knee braces, sometimes called "fillets", are used with semi-rigid deck superstructures to augment the cantilever action of the finger and main walk stringer connection (Figure 7.8). A well designed junction with knee braces can accommodate the lateral loads of a finger float up to 40 ft (12.2 m) long (Dunham and Finn, 1974). Longer fingers should have an anchor pile located on the outboard end.

Knee brace configurations have traditionally been a 45° triangle for simplicity of design (Dunham, 1969), with a leg length equal to the width of the finger float. There is a trend however toward the use of a skewed knee with the longer leg on the finger side. The longer brace stiffens the finger by reducing its unbraced cantilever length

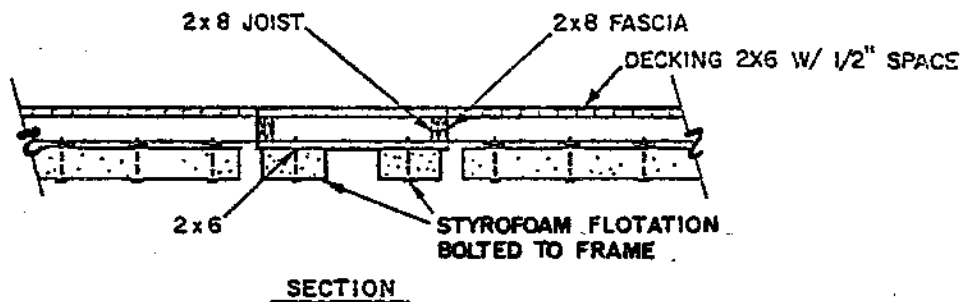
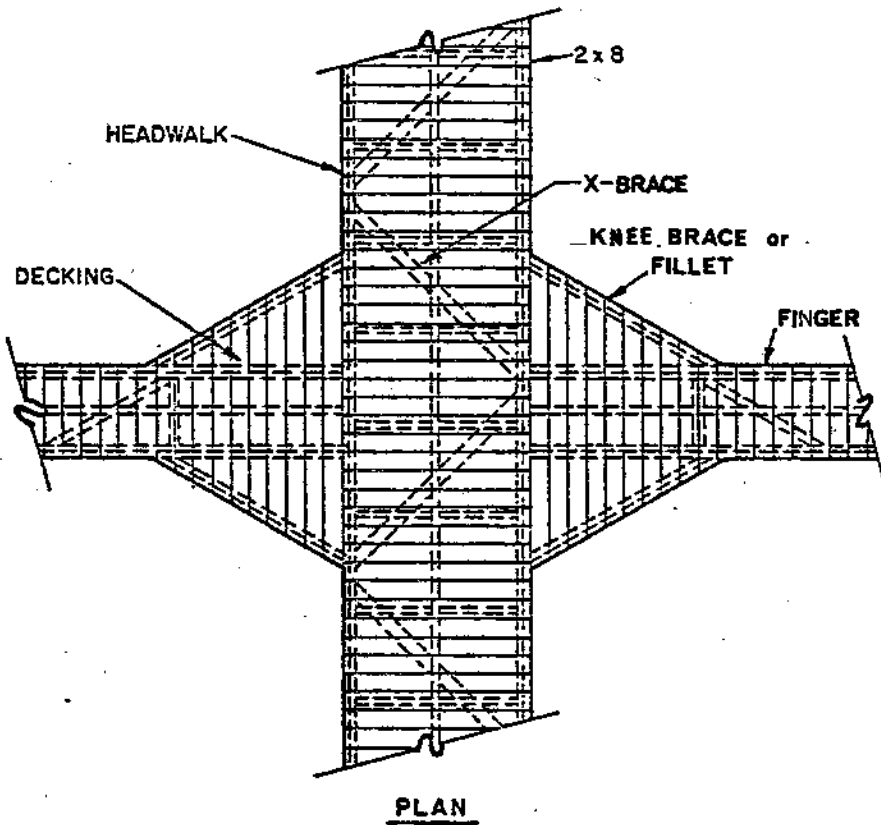

Figure 7.8 Floating Dock Braces (Winzler and Kelly, 1979, p. VI-8)

and is favored for long fingers, large craft, and high wind load areas.

Metal and wood are the materials commonly used for knee braces. Metal knees are typically steel members consisting of angles of at least $\frac{1}{4}$ in. (6.4 mm) thickness (Curry, 1979). Wood knees are usually constructed of the same size members as the waler on the outside of the pontoons. Both wood and metal knee braces are then covered over by the decking material. While anchor piles are frequently located inside the knee braces of a floating dock, the decking or cover plate should not be used to support the pile guides. The pile guides instead should be attached to additional framing members that transfer pile loads directly to the structural elements of the main walk. One disadvantage in the use of knee braces is that they encroach somewhat on berth space and are therefore subject to more frequent impact damage by boats. Also, larger commercial fishing vessels may not be able to berth with the stern close to the main walk for ease of boarding.

Internal x braces (Figure 7.8) are installed between the pontoons and stringers of the timber deck superstructure of some floating docks, piers, and wharves. The primary function of x bracing is to stiffen float systems in a horizontal plane to resist torsional and lateral loads better without large deflections. A secondary purpose of these members is to provide adequate bearing area for thin shelled foam flotation elements. When used with diagonal deck planking, the x braces should be installed in the opposite direction for a cross-bracing effect.

Strut systems and torque pipes, unlike x braces, are installed solely to resist torsional buckling stresses in the deck framework. Torsion is induced in a number of ways including eccentric deck loading, boat impact loads that are not applied at deck level, and various

combination loads because of waves and wind. Unbraced stringer and deck arrangements are easily twisted because the high point of attachment of the deck forms a "C" section that is relatively weak in torsion. X braces are effective in resisting this torsional stress because of their low plane of action. Strut systems (Figure 7.9) have also been found very effective in resisting torsional buckling. Struts and cross ties are placed at frequent intervals to reduce the clear stringer length in which buckling can occur. Torque pipes typically consist of 3 to 3½ in. (76 to 89 mm) galvanized pipes with plates welded to each end (Dunham, 1969). These plates are then bolted on one end to the main walk stringer and, on the other, to the end partition of a finger float (Figure 7.10). The finger float cannot twist then without exerting a torsional stress on the pipe which resists this load essentially as a very stiff spring.

As a final note on floating dock, pier, and wharf bracing systems, it should be noted that the effectiveness of the braces discussed depends on their connections being strong and tight. If braces are not properly maintained, the structural integrity of the entire installation can deteriorate rapidly, followed closely by the need for major repairs.

Decking

The design considerations regarding decking for floating docks, piers, and wharves are similar to those pertaining to fixed structures as addressed in Chapter 6, and will not be repeated here. One factor that becomes important with floating systems, however, is weight. Heavier decks feel and sound more secure under foot, but indirectly boost overall costs because of the extra flotation required.

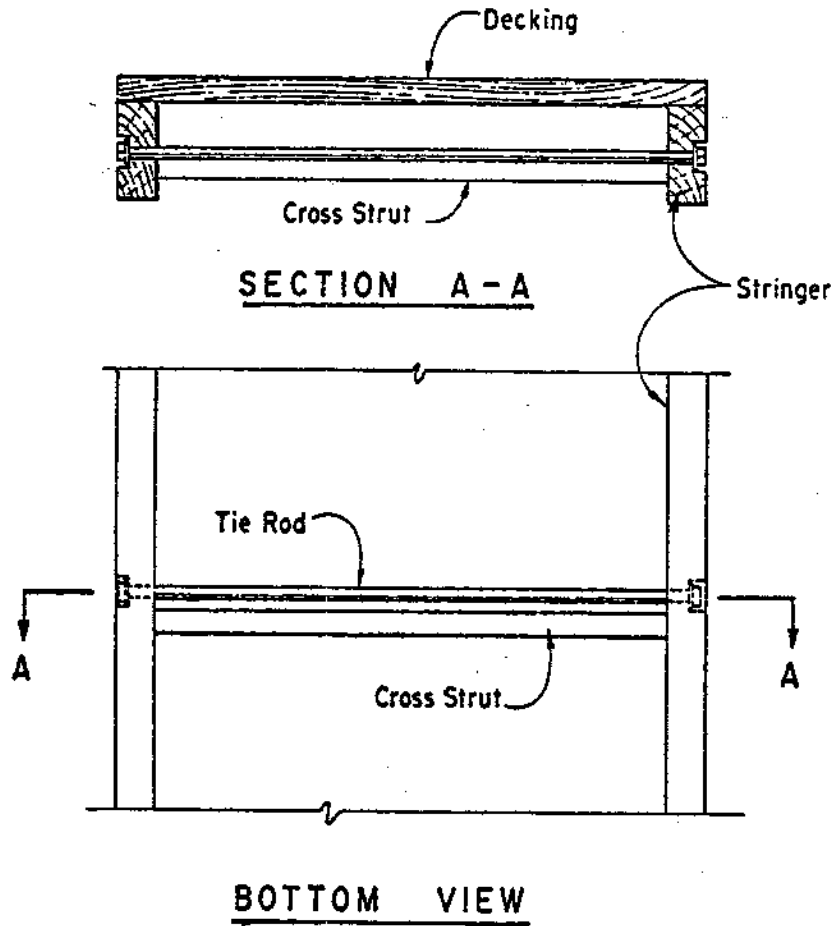

Figure 7.9 Crossties and Struts Used to Strengthen Floating Pier Decks (Dunham and Finn, 1974, p. 149)

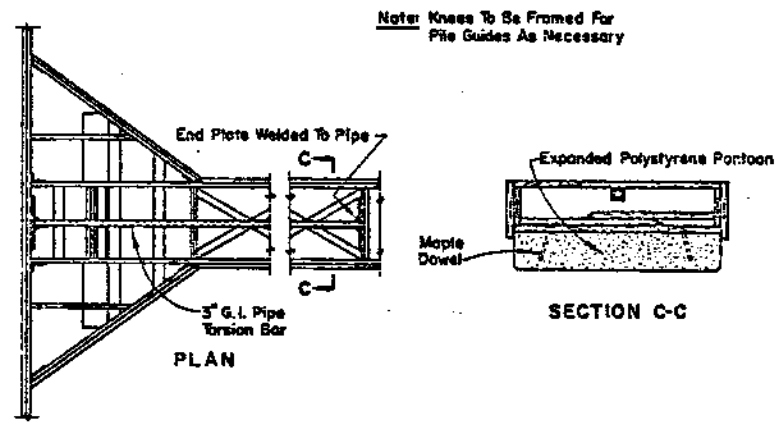

Figure 7.10 Deck Framing Stiffened with a Torque Pipe
(Dunham, 1969, p. 111)

Gangways

Gangways for floating docks may be identical to those of fixed structures with the notable exception being the end connections. Since the float system must move up and down relative to the wharf it is attached to, rigid connections cannot be used. Gangways for float systems anchored by means of pipe struts or stiff arms can be hinged both top and bottom (Figure 7.11). In most cases, however, the floats are anchored by guide piles which require that one end of the gangway be free to slide in and out as the deck rises and falls. While simple metal guides are adequate for light gangways, wheels are commonly used to reduce the sliding friction for heavier gangways (Figure 7.12).

The design of the floating dock under the lower end of a gangway must compensate for its concentrated weight. Two methods are commonly used, including adding additional pontoons to pick up the load, or using a pile supported counterbalance system as in Figure 7.13.

Gangways are most often designed as lightweight decks supported by truss systems combined with the side handrails. In this manner, adequate length can be achieved without weight that would be associated with simple beam design. Examples of gangways are illustrated in Figure 7.14. The deck of these ramps should be covered with a non-skid surface, or have cleats affixed to it on 1 ft (0.3 m) centers (State of California, 1980). A maximum slope of 3:1 is allowable at extreme low water.

Connections and Hardware

The connections of floating docks, piers, or wharves are perhaps the most critical areas the designer must address. The two basic approaches

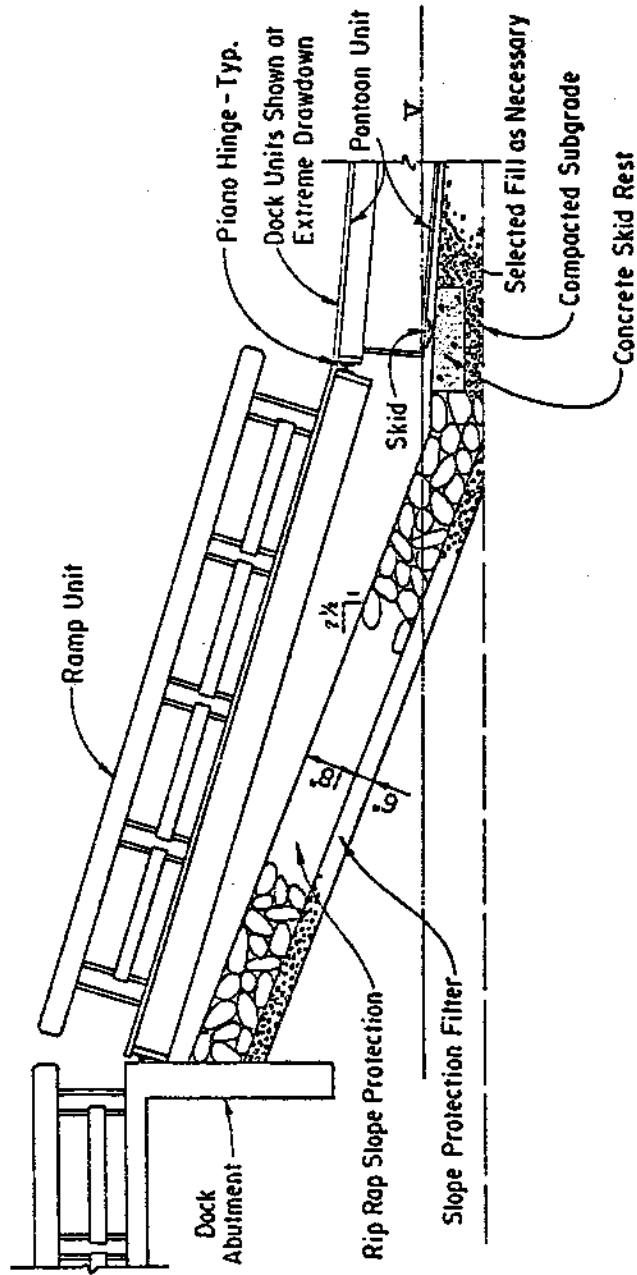

Figure 7.11 Floating Dock Gangway (Dunham and Finn, 1974, p. 282)

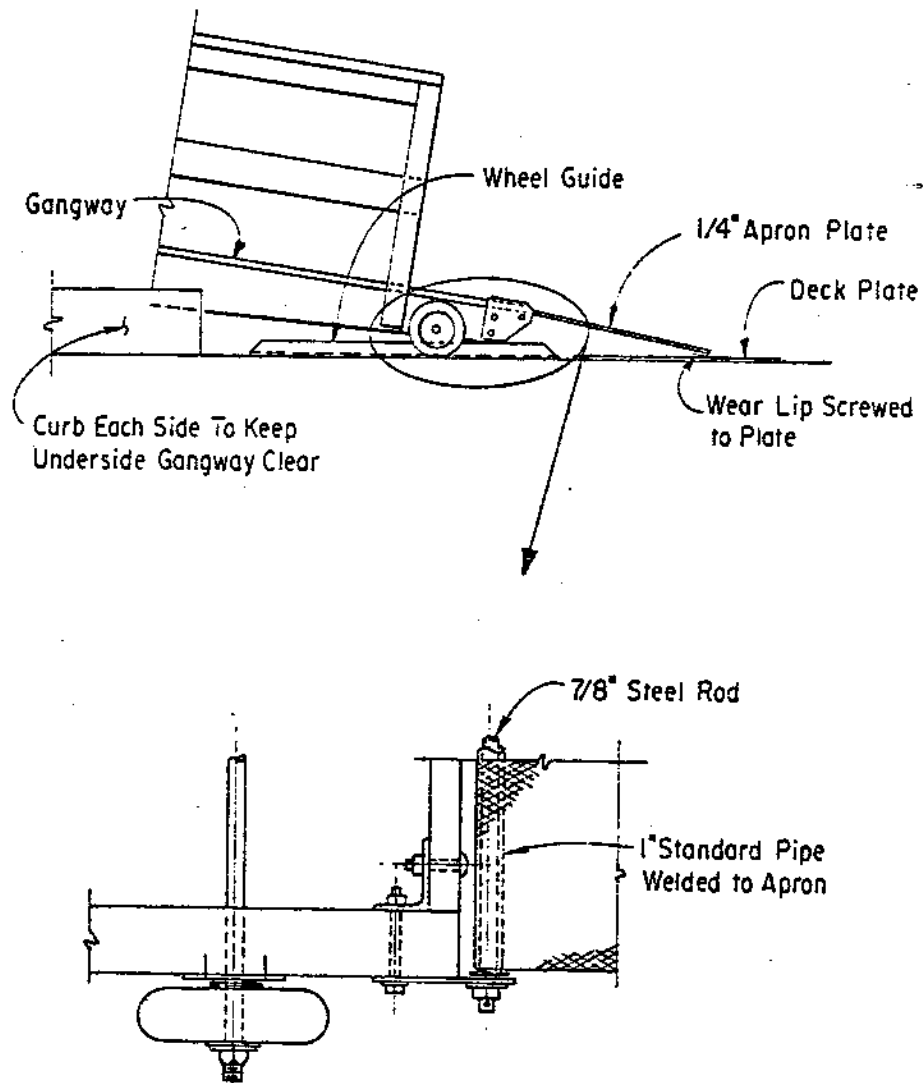
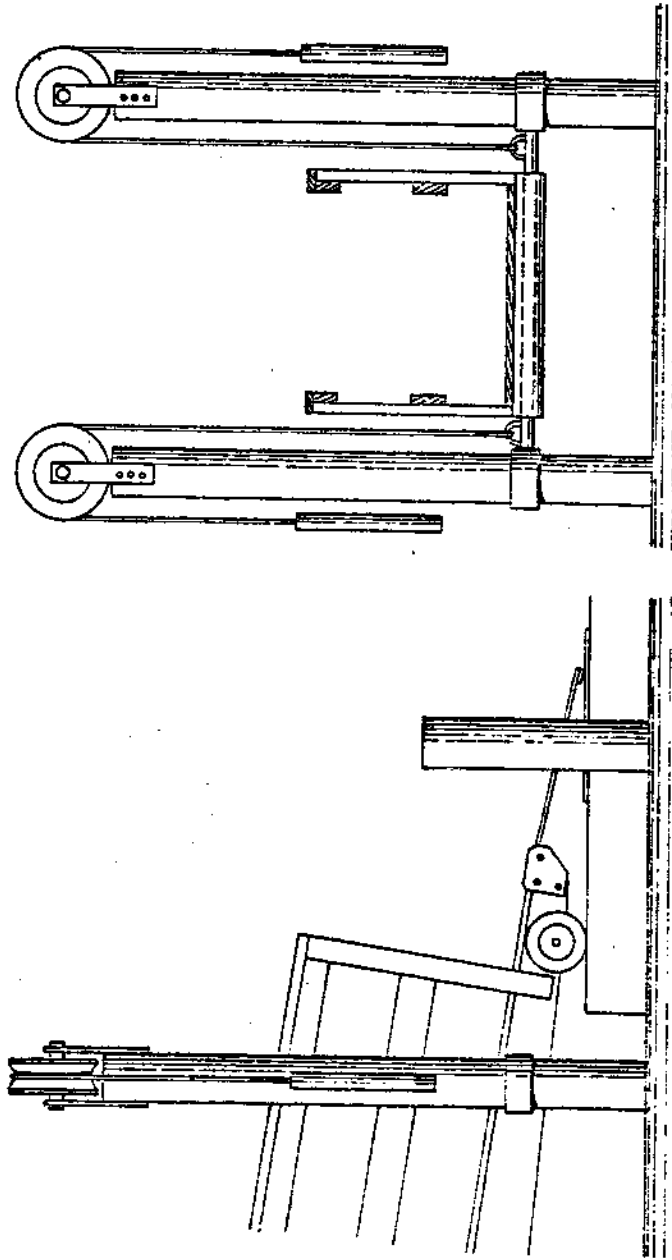

Figure 7.12 Wheel Guided Gangway with Apron Plate
(Dunham and Finn, 1974, p. 159)



ELEVATION

SECTION

Figure 7.13 Gangway Counterbalance System (Dunham and Finn, 1974, p. 257)

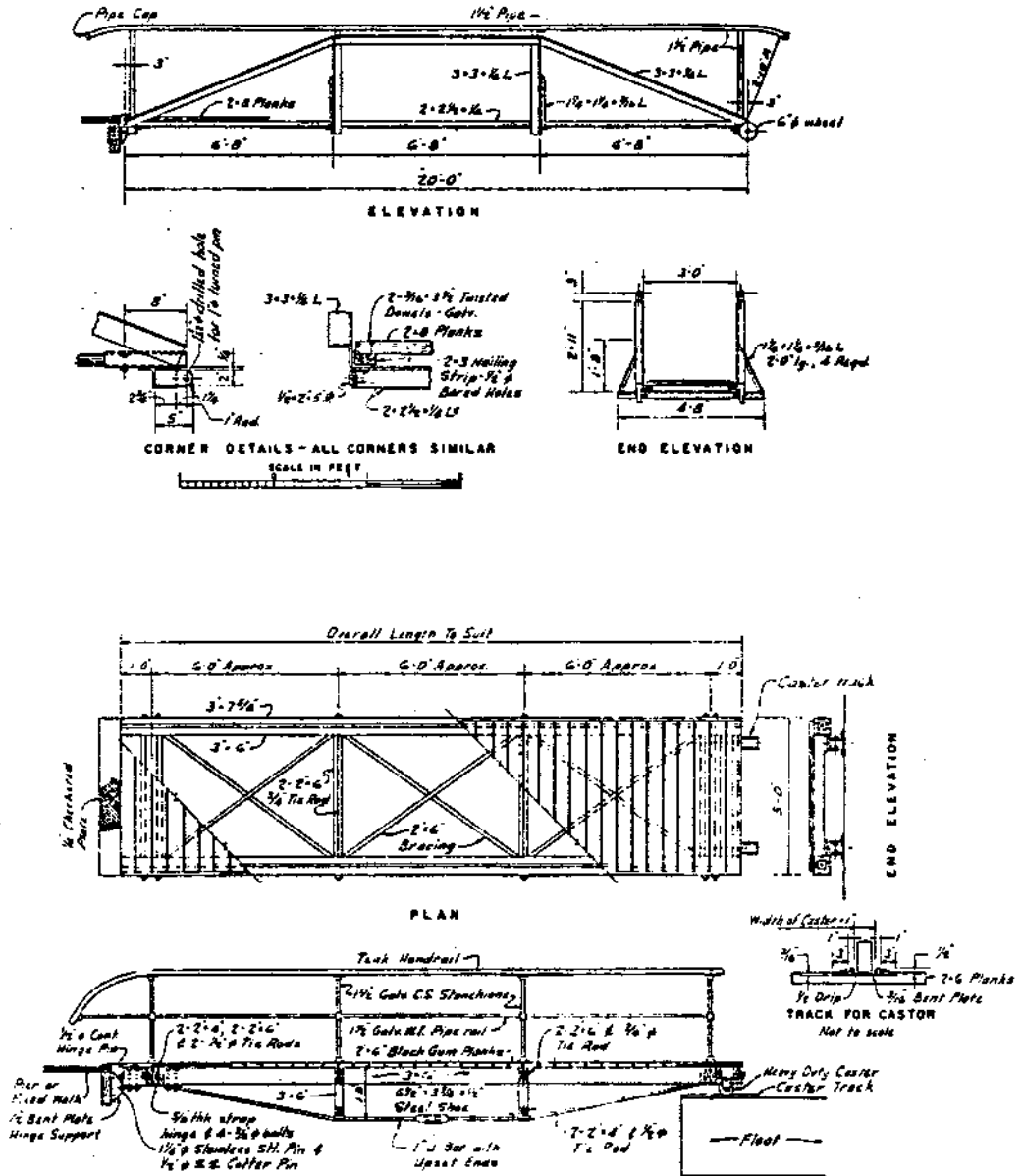

Figure 7.14 Truss Supported Gangways (Chaney, 1961, p. 143)

to connection design are to use rigid junctions that transmit stresses between connected members, or to provide hinges that allow displacement of the joint under load. Dunham (1969) states that rigid connections provide for long life with respect to the deck framing of most floating piers. Actually, the term "rigid" is probably inaccurate in describing float system superstructure, and instead Dunham and Finn (1974) suggest "semirigid". It was noted earlier that stringer systems may be subjected to deflections of 1.5 ft (0.46 m) vertical in 45 ft (13.7 m) horizontal. Included in this stringer system are both stringer-to-stringer splices, and finger float/headwalk junctions that must be designed to accommodate these large deflections in flexure. Figure 7.15 illustrates one example of a semirigid crosslocked connection of finger and headwalk stringers.

The most efficient framing is obtained when fingers lie opposite each other along the headwalk and provide balanced loading conditions. When they do not, header framing is difficult and may lead to torsion in the mainwalk. It is very important for the durability of semirigid connections that they not be allowed to loosen enough to form an artificial hinge. Bearing this in mind, the designer must be careful to specify fasteners that do not overstress and crush the wood fibers and create a "working joint" (Dunham, 1969).

Hinged connections between float sections and at the finger float/headwalk junction may be necessary for stiffer stringer materials, heavier pontoons, or excessive environmental loading conditions. Monolithic concrete floats, being of great dead weight and low tensile strength, are a prime example. Since vertical bending stresses from a concrete finger float cannot be transmitted to the header, a hinge must be pro-

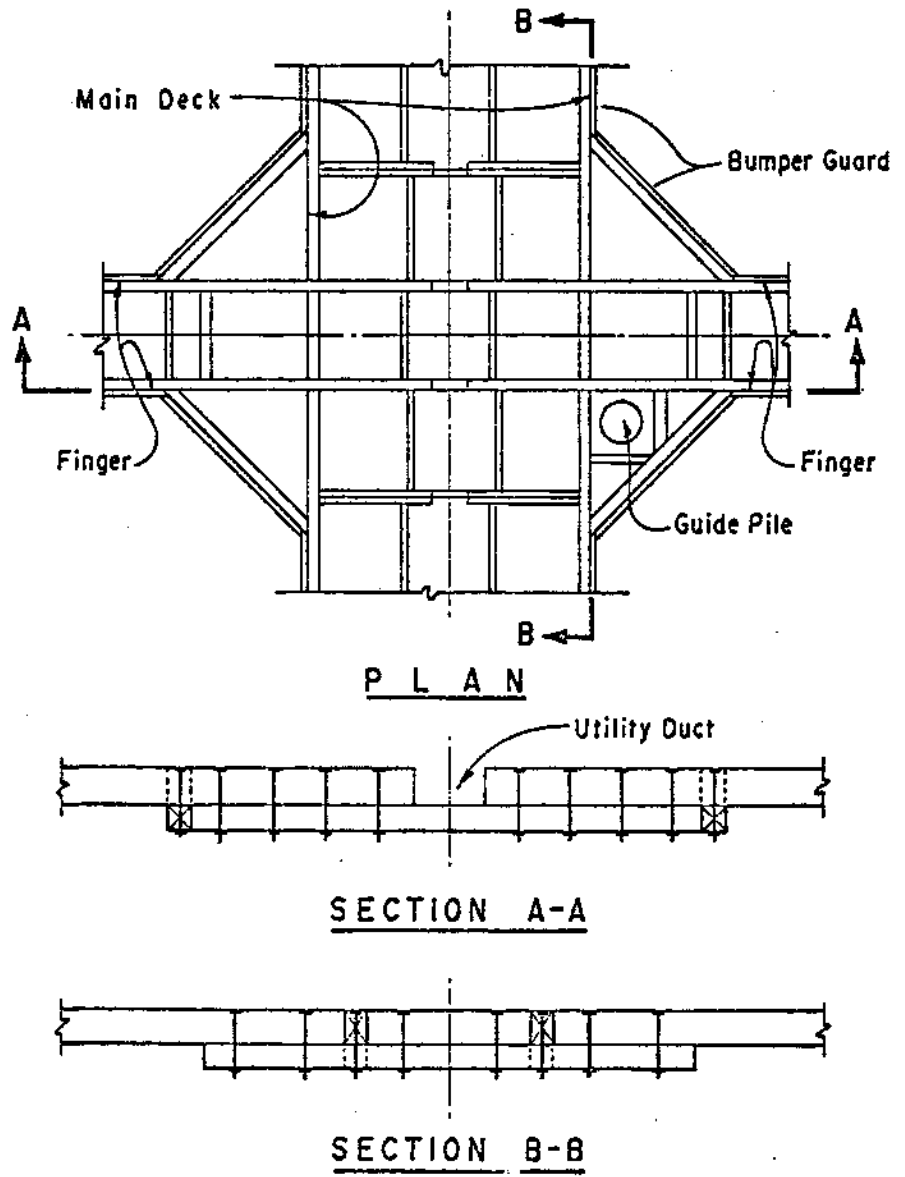

Figure 7.15 Crosslocked Connection of Finger and Headwalk Stringers (Dunham and Finn, 1974, p. 150)

vided (Dunham, 1969). Where necessary, hinges should be massive, with large diameter pins that are closely fitted. Poorly maintained hinges wear rapidly, however, soon becoming loose and noisy (Dunham and Finn, 1974). Curry (1979) notes that hinges should be avoided whenever possible since they allow too much movement and "tear up" the pontoons. Hinge fittings are illustrated in Figure 7.16.

The fasteners used in floating dock, pier, and wharf construction are in most cases identical to those used in fixed structures as presented in Chapter 6. For this reason, no further discussion of fasteners will follow.

7.5 FLOATING DOCK MOORAGE

Moorage design for floating docks is essentially the same as for fixed docks. The fundamental difference is that floating docks move vertically with the berthed craft in response to tides or long period surge, while fixed docks are stationary. The most common mooring system is the double berth with cleats, tie lines, and tie piles as shown in Figure 6.27. Traveling irons (Figure 6.28) are used on the tie piles for large water level fluctuations (Chaney, 1961). Section 7.6 should be consulted for general small craft mooring design considerations.

7.6 FLOATING DOCK FENDERS

Fenders for floating docks are less complex to design than fixed dock fenders because the docks remain at approximately the same level with respect to the berthed small craft. Floating dock fenders generally take the form of a rubrail affixed to the face of the dock in such a manner that it contacts the boat hull first. The various materials used have included wood rub strips, old rubber tires, discarded fire hose, or hemp hawsers,

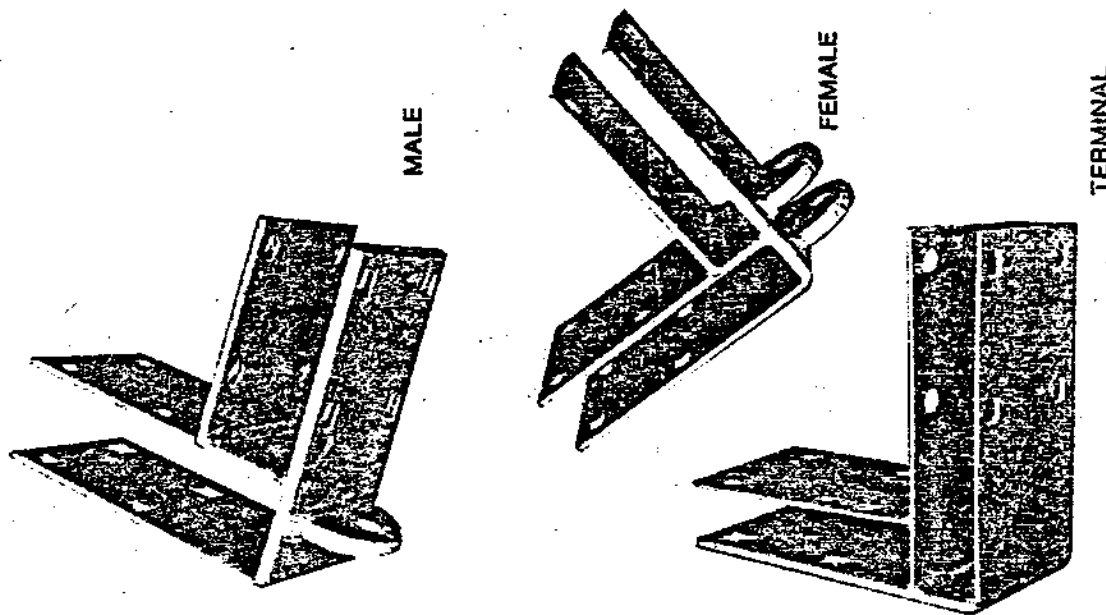
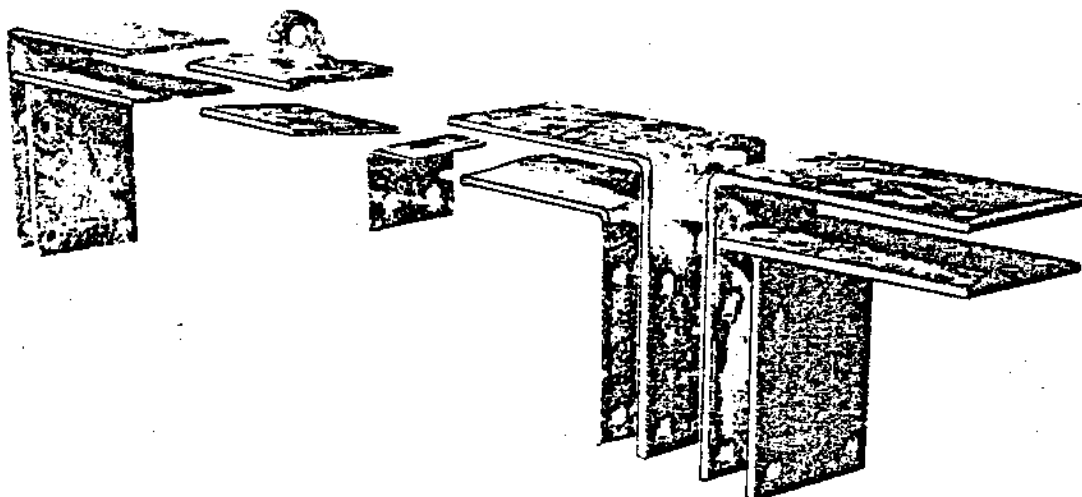

Figure 7.16 Hinge Connectors (Marine Docks, pp. 6, 7)

but these fender types are unsightly and not particularly durable (Dunham and Finn, 1974). Special synthetic extrusions or molded shapes (Figure 7.17) are now being manufactured that solve these problems. Butyl rubber and neoprene are durable synthetics that are used for fender materials when reinforced with metal strips through the attachment points.

7.7 ANCHORAGE SYSTEMS

Floating docks, piers, and wharves must be provided with some form of anchorage system to maintain their position when subject to lateral loads. The anchorage system must allow vertical movement with all fluctuations of the water level while restraining horizontal movement because of wind, water current, and boat, ice, or floating debris impact. The magnitude and proper combination of these loads is addressed in Chapter 3. There are two general groups of anchorage systems for floats. The first consists of various types of guides that attach the floats to piles or other fixed support. The second group includes cable and sheave systems that work in conjunction with bottom and shore anchors. The choice of a system depends primarily on the depth of water in the basin, and the amount of water level fluctuation that must be accommodated. A third group that pertains to the anchorage of covered berths will also be addressed briefly.

The restraint methods of the first group include anchor piles with pile guides, anchor piles with traveling irons, traveling irons attached to other fixed structures such as bulkheads or breakwaters, and stiff arms or pipe struts. Water level fluctuations of approximately 10 ft (3.0 m) can be safely accommodated by most of these systems (Chaney, 1961). The simplest and most common are the anchor piles which are suitable for water depths up to 30 ft (9.1 m) according to Dunham (1969).

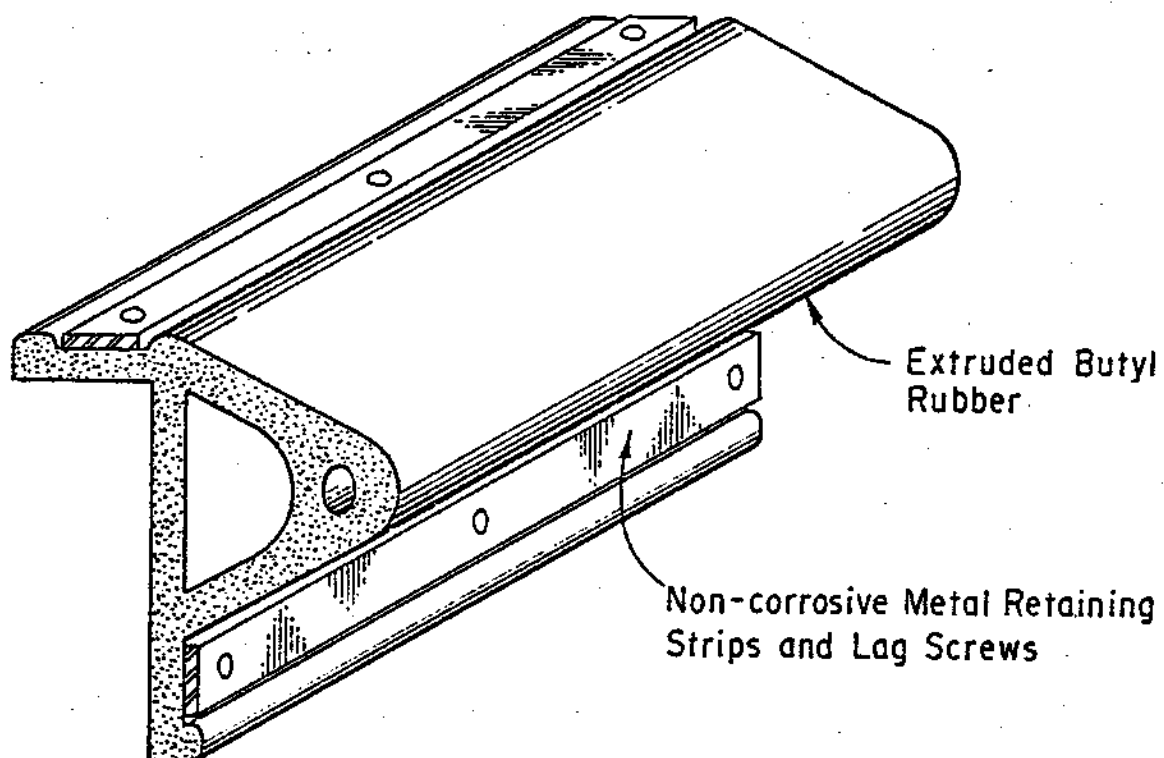

Figure 7.17 Floating Dock Fender (Dunham and Finn, 1974, p. 179)

Piles are intended to resist lateral loads at the water surface through cantilever bending. This requires that they be firmly fixed in the harbor bottom. If the basin depth is too great, or the substrata too soft, the anchor pile must be very large to be sufficiently rigid (PIANC, 1976). In such cases, pile costs soon become prohibitive and cable anchorage is more economical.

All of the various types of piles, with the exception of cast-in-place concrete, are used for anchorage. While treated timber is the most common, prestressed concrete, structural steel shapes, and railroad rail have all been used. Timber is popular because of its low cost and flexibility. Prestressed concrete piles are preferred over conventionally reinforced concrete because of their greater bending strength and durability. Small diameter metal pipe such as well casing may be used in well protected areas, but the system must be carefully designed to avoid overload (Dunham, 1969).

The design and layout of an anchor pile system may be approached from two different outlooks. First, given the pile geometry (diameter and length), the penetration depth, and the soil properties of the substrata, an allowable load for each pile may be calculated. Dividing the allowable load per pile into the total horizontal load on the float system will determine the number of piles necessary for safe anchorage. The alternative is to locate piles for uniform stress distribution in the deck members, thereby determining the number of piles to be used. The necessary capacity of each pile is then calculated and it determines the pile geometry and embedment depth, given the soil properties of the harbor bottom. The spacing of piles is a matter

of judgment that depends on the rigidity of the dock in the horizontal plane, and the magnitude of the lateral loads to be resisted (Dunham and Finn, 1974). Efficient structural design would dictate that the anchor piles be located at the finger ends and the knee braces of the slips as illustrated in Figure 7.18. Additional piles are usually provided at the "T" head of main piers under the assumption that it will be used as a breasting dock for large cruisers.

Cheung and Kulhawy (1981) should be consulted for the design procedures for lateral loads on individual piles. Anchor piles are generally designed as free-headed members with the exception of a sleeve-guide that has been used to fix effectively the head of the pile against rotation. Sleeve-guided anchor piles are addressed in a subsequent section. The load applied to an anchor pile must be introduced at the highest possible point of application which is assumed to be the expected maximum still water elevation plus the design wave height plus the height of the pile guide over the water (Dunham, 1969). While the pile guides of a float system will rarely contact all the anchor piles simultaneously, it is commonly assumed that the piles are sufficiently flexible to permit even distribution of load (Dunham and Finn, 1974).

The installation of the anchor piles for a floating dock, pier, or wharf presents a potential problem. Pile driving equipment is often too big to drive the piles after the floats are in place. Instead, the float system is moved into place after the piles are carefully driven at predetermined positions using shore control (Dunham and Finn, 1974).

Dunham (1969) suggests that anchor piles placed in sandy soils should be jettted in to obtain more precise positioning and minimize driving damage to the pile. Jetting should not be used with cohesive

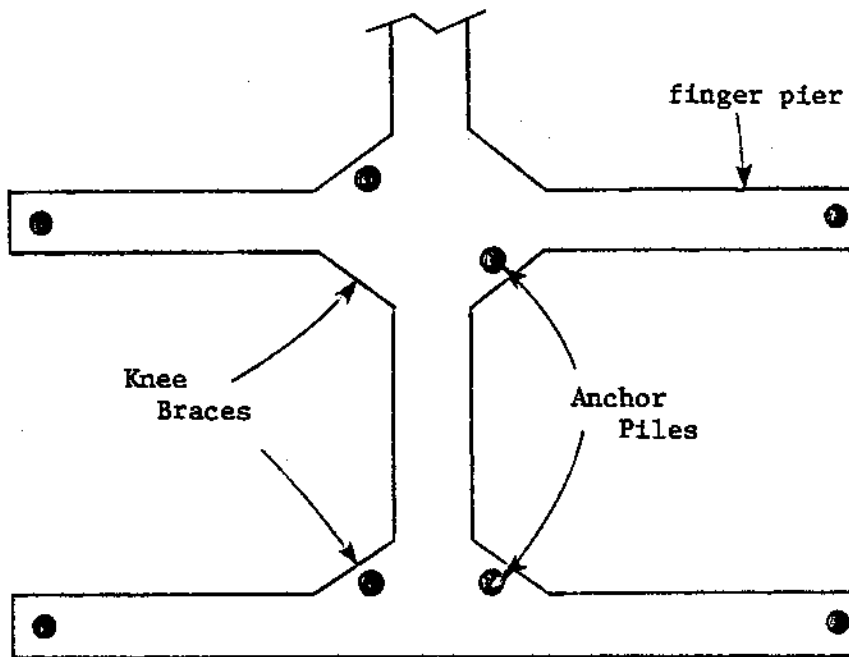

"T" Head

Figure 7.18 Anchor Pile Location

substrata, however, since the soil will not properly fill the voids around the pile and form a good bond. Anchor piles so placed will have a low capacity and may work loose under frequent stress reversals. In hard rock substrata, anchor piles have been grouted into predrilled or blasted holes (Dunham, 1969). Although this provides excellent fixity for high capacity anchor piles, the procedure is expensive and cable anchorage is probably indicated. While float systems have been designed that place the anchor pile in the middle of the deck, a location on the float perimeter or in the knee brace is to be preferred (PIANC, 1976). In this manner, over-water construction may be minimized, and a clear deck is left for pedestrian traffic.

Pile guides are used to transmit the lateral loads of a floating dock or pier to the anchor piles that resist these loads. While slack or free play should be minimal, the guide must not be so tight that it abrades the anchor pile or damages the structural member of the float deck to which it is attached. Guides that surround the pile are preferable since open sided guides do not carry any load in one direction and therefore cause unusually high loads on other piles (Dunham and Finn, 1974).

The various types of pile guides may be separated into two general groups: pile yokes and pile rollers. There are yokes as well as roller systems, and yoke and roller combinations are also available. Pile yokes are typically fabricated of wood and/or steel and are illustrated in Figure 7.19. Note that for the purposes of this report, rectangular wood collars that are framed into the deck of a float are considered yoke guides. The most common pile yokes according to Curry (1969) are metal hoops. These guides work well with wood piles, but Curry

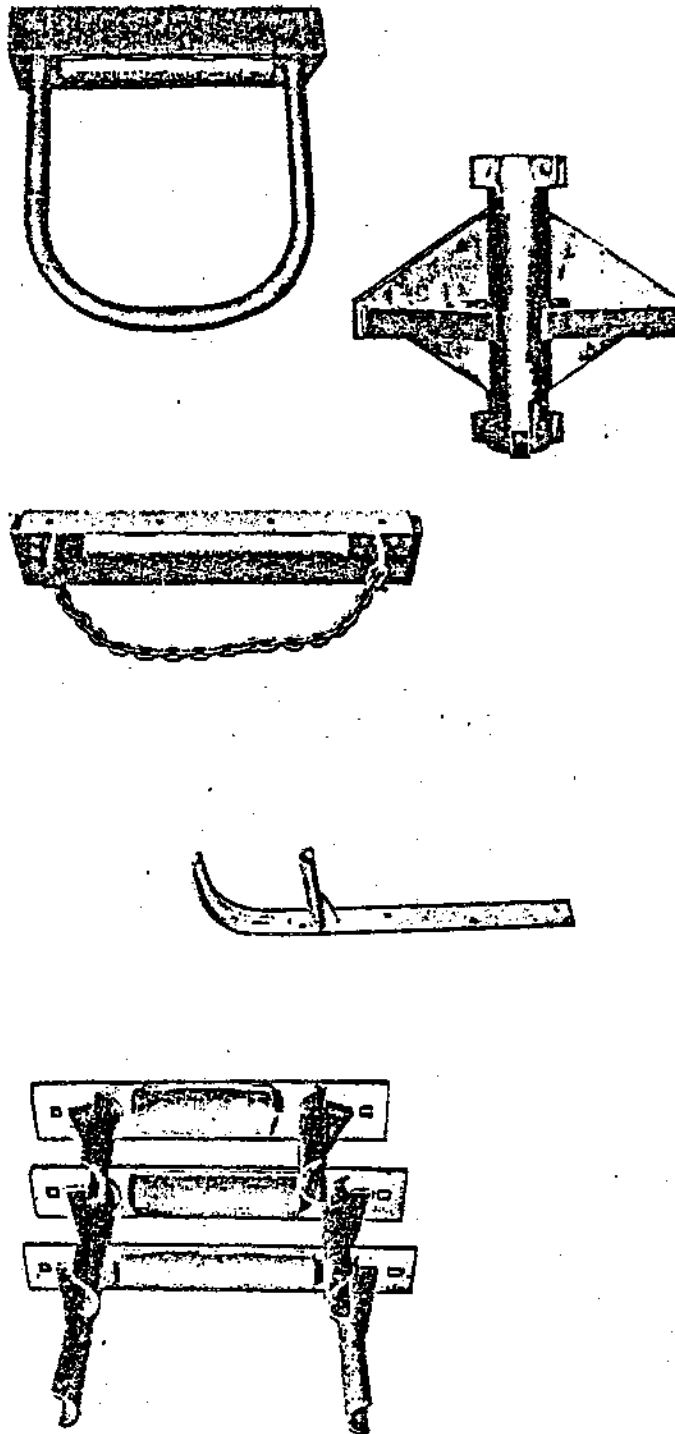

Figure 7.19 Pile Yokes (Marine Docks, p. 10)

(1979) has observed that 50% of a pile cross-section has been worn away in the tidal zone of severe surge areas. Steel yokes perform acceptably well on steel piles with the main objection being that they are noisy. Dunham (1969) recommends the use of metal or hardwood bearing strips attached to the pile to reduce pile damage and noise. Curry (1979) suggests wood or rubber wear strips and notes that 4 by 4 in. (102 by 102 mm) oak has been observed to work well for many years. Sleeve guides are used on some float systems in conjunction with small diameter pipe piles. Given that the deck structure is very stiff in torsion, a sleeve that fits closely will fix the pile head against rotation. Theoretically, the load capacity of a sleeve-guided pile is increased significantly when compared to a free-headed pile of the same diameter. While a pile fixed against rotation at the top is apparently more rigid, the analysis is made complex by the flexibility of the pile and the float components. Furthermore, any wear in the pile sleeve or loosening of the float connection can lead to a reduction in the degree of head fixity which results in lower anchor stiffness and greater deflections. Cheung and Kulhawy (1981) should be consulted for the design of sleeve-guided anchor piles.

File rollers are illustrated in Figure 7.20. They are generally made of hard rubber with axles of stainless steel. Rollers are more expensive than wear strips and yokes but look more "clean" and modern (Curry, 1979). They are also more quiet since they do not subject the pile to scraping and wear. Wear of the roller itself may be a problem however. Rollers do not generally work well against round piles (especially concrete) and the rubber wears out prematurely in the middle. The State of California (1980) recommends octagonal concrete piles which

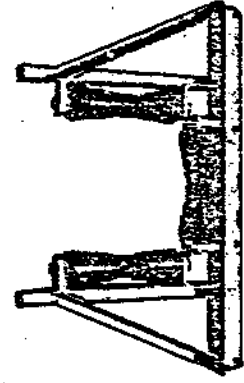
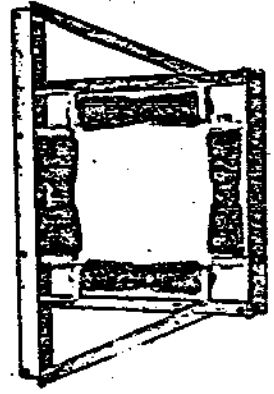
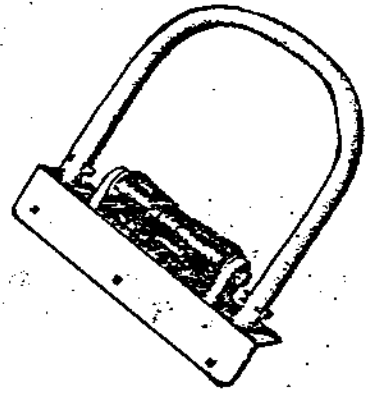

Figure 7.20 Pile Rollers (Marine Docks, p. 10)

offer the appearance of a round pile but still provide flat bearing surfaces for the roller guides. Square concrete piles are the least expensive of the concrete piles and, while they work well with roller guides, they often rotate during driving and present an unattractive appearance.

Traveling irons attached to anchor piles (Figure 7.21) are very similar in performance to anchor pile/roller guide systems. The traveler bar is connected to the floats by means of a metal ring which allows very little slack and results in a quiet, dependable system. Traveling iron anchorage systems are much stiffer when fastened to bulkheads or fixed piers since these structures cannot deflect as an anchor pile does. Chaney (1961) notes that while traveling irons can tolerate a maximum advisable water fluctuation of 9.5 ft (2.9 m), they become costly if this range exceeds 7 or 8 ft (2.1 or 2.4 m). A variation of the traveling iron that is suggested by Chaney (1961) is the T-bar (Figure 7.22). The T-bar is a more substantial member that is capable of withstanding greater horizontal forces and greater water level fluctuations. Note that no stops are provided on the top or bottom. In the event of extreme high or low water, the dock can then float free without damage.

The final group one restraint method to be addressed is the pipe strut or stiff arm system. This type consists of a series of rigid struts or ramps that are hinged at the top to a bulkhead or other fixed structure, and at the bottom to a row of floats (Figure 7.23). The water level fluctuations that can be accommodated by this system depend on the length of the strut. Chaney (1961) notes that a "dead water space" between the bulkhead and float line is a necessary product of

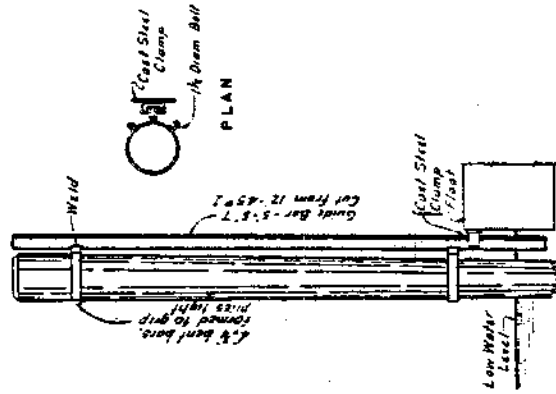

Figure 7.22 T-Bar Guide (Chaney, 1961, p. 135)

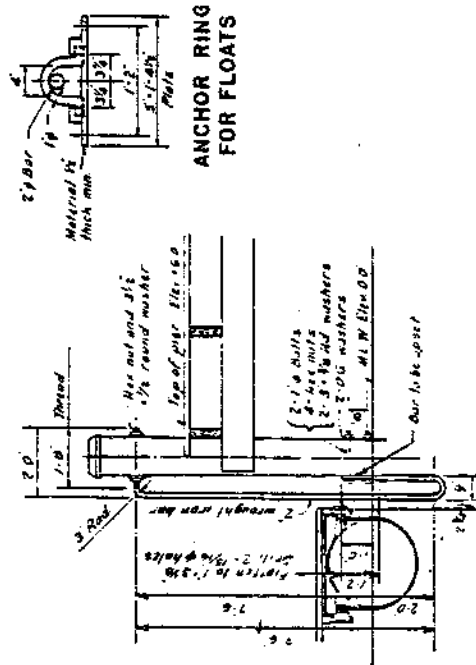

Figure 7.21 Traveling Iron Guide (Chaney, 1961, p. 143)

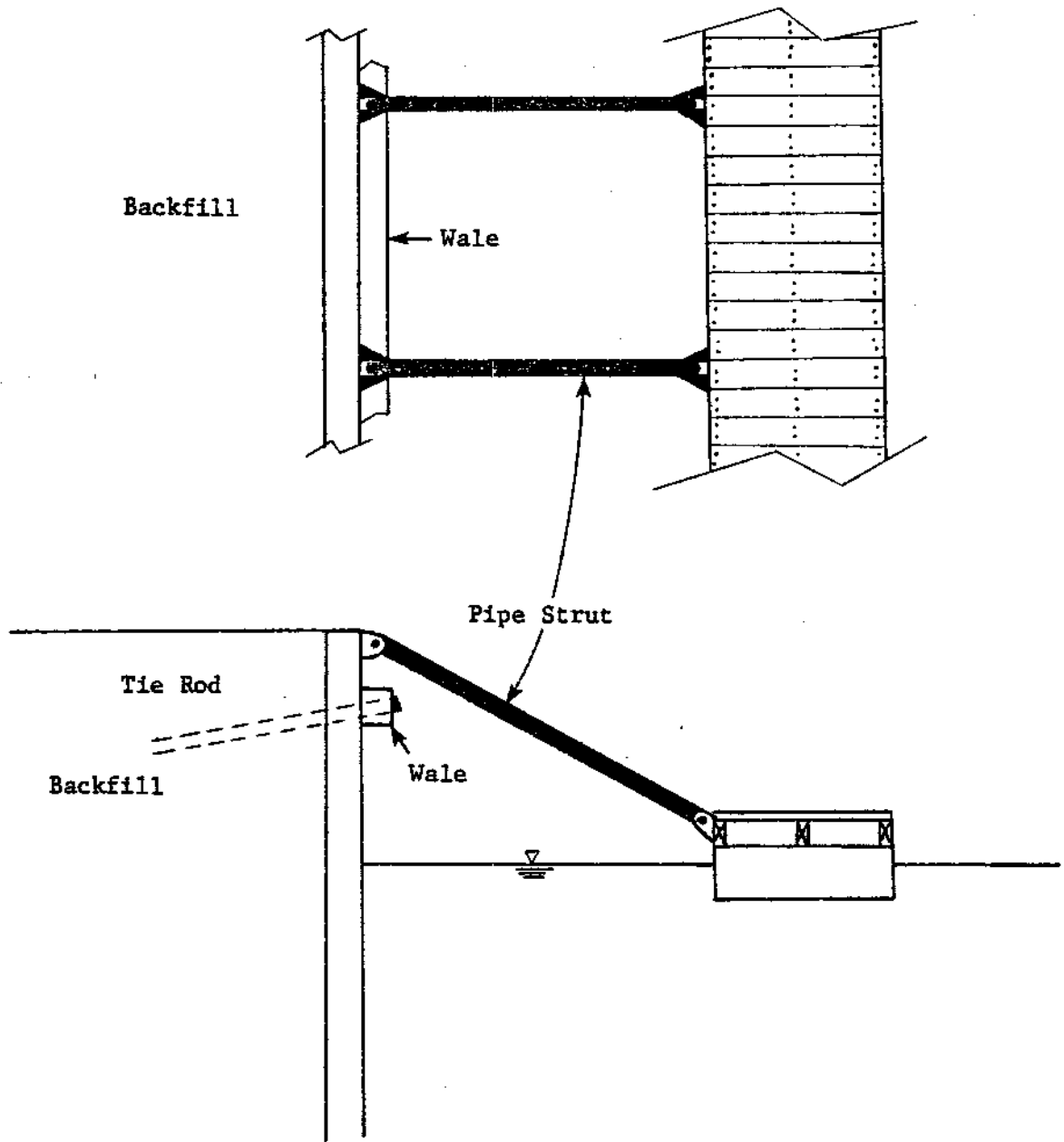

Figure 7.23 Pipe Strut or Stiff Arm Anchorage

stiff arm anchorage and longer arms waste more area. Regardless of strut length, however, the entire float system will move toward and away from the support point with changes in water level. This precludes the use of anchor piles or cable systems as supplemental anchorage.

Cable and sheave anchorage are favored over the previously discussed systems for water depths in excess of 30 ft (9.1 m) and water level fluctuations greater than about 10 ft (3.0 m). Anchor piles of suitable stiffness must be too large to be economical in deep water. Furthermore, piles intended for water level changes in excess of 10 ft (3.0 m) are too flexible at high water and unsightly at low water. Cable anchorage may also be more practical at lesser overall depths and level changes when ledge rock or very soft bottoms make pile driving difficult. Another disadvantage of pile anchorage systems that is partially overcome by cables is the hindrance to dredging operations (PIANC, 1976).

There are many variations of cable anchorage systems, and their arrangement depends largely on site specific conditions. In general, two anchor lines diverging at 45° are attached to the outer corners of a float system, and two lines tie the system back to the shore (Dunham, 1969). Larger installations require more lines and larger anchors. Two examples of drawdown adjustable systems are illustrated in Figures 7.24 and 7.25. The type of anchor used depends on bottom soil conditions, profile, and the magnitude of the expected loads. Common anchors for small installations are shown in Figure 7.26. Since these anchors derive most of their resistance from embedment in the bottom, the line pull should be kept as near horizontal as possible. Dunham (1969) suggests that a "sinker" be attached to the midpoint of

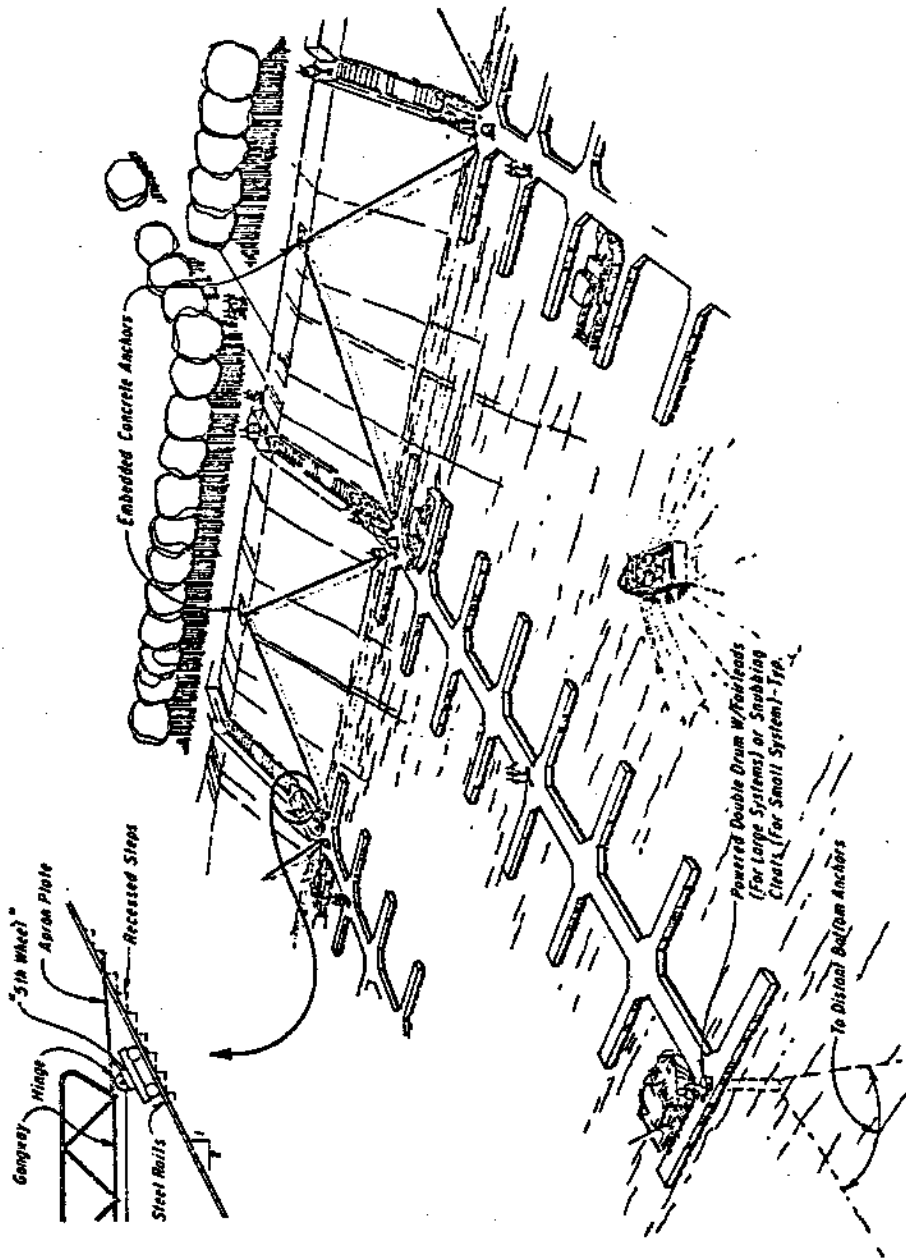

Figure 7.24 Deepwater Cable Anchorage of Floating Pier (Dunham and Firm, 1974, p. 147)

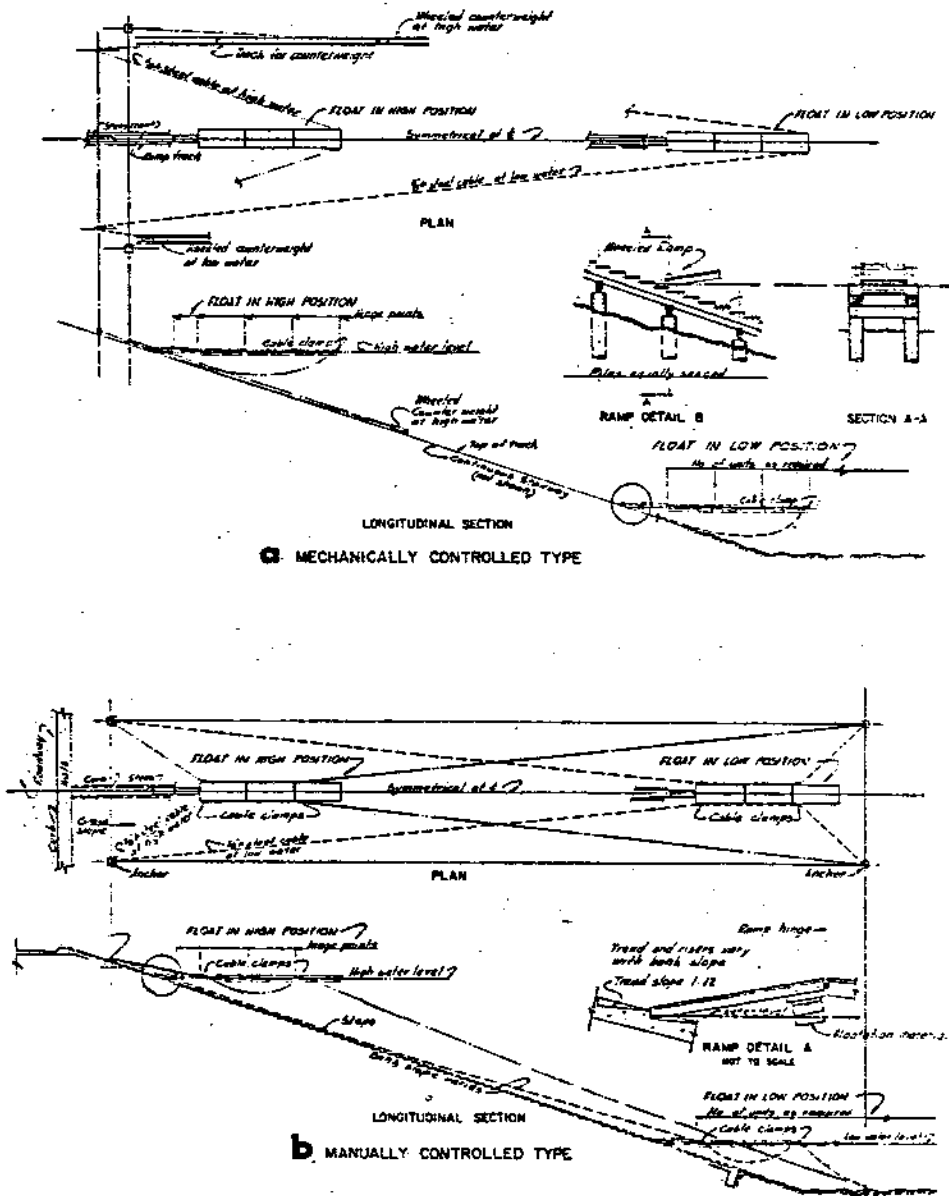
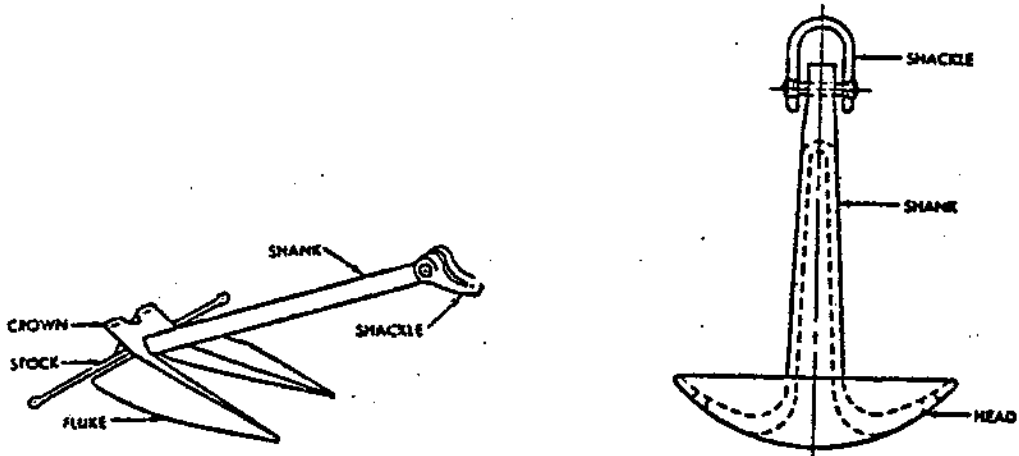
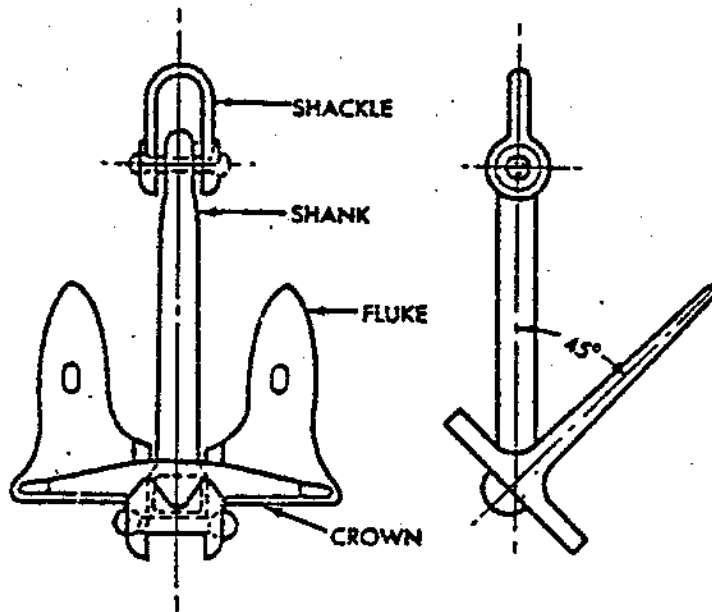

Figure 7.25 Drawdown Adjustable Anchorage (Chaney, 1961, p. 142)



a. Danforth-type Anchor

b. Mushroom Anchor



c. Navy Standard Stockless Anchor

Figure 7.26 Soft Ground Anchor Types (Ehrlich and Kulhawy, 1982, p. 66)

the anchor line to flatten the lower part and steepen it near its float attachment point so as not to foul boats moving nearby. Fisher (1980) states that for optimal performance, the angle between the bottom and the anchor line or "rode" should not exceed 8 degrees (Figure 7.27). Concrete weights and large boulders are also used as anchors and rely on their mass to resist dragging. High capacity plate anchors that require direct embedment in soft bottoms have been developed recently. These anchors are inserted in the bottom sediments by means of explosive propellants (Figure 7.28) or vibration. Field test data of anchor capacity is available from the Naval Facilities Engineering Command for conventional anchors (Taylor, 1980; Taylor and Rocker, 1980) and plate anchors (Beard, 1980).

Anchors are connected to the docks floating above by means of cables or chains. An adjustment should be made in the amount of flotation at the attachment point because of the weight of the anchor line. Cables are lighter than chains for a given tensile strength, they are not as durable, and chains may be substituted to obtain a longer life. Wrought iron chains are preferable to those of mild steel in corrosive environments (PIANC, 1976). The upper portion of the chain or cable is most subject to corrosion and provisions should be made for splicing or repair. In very deep water, transverse chains may be hung from pier to pier with ground anchors only at the extreme side piers. These chains must be deep enough that they do not obstruct or foul boats moving around the harbor.

Covered floating berths generally require much more substantial anchorage than an open system because of the large side area presented to wind loading. An ordinary guide-pile arrangement may be sufficient

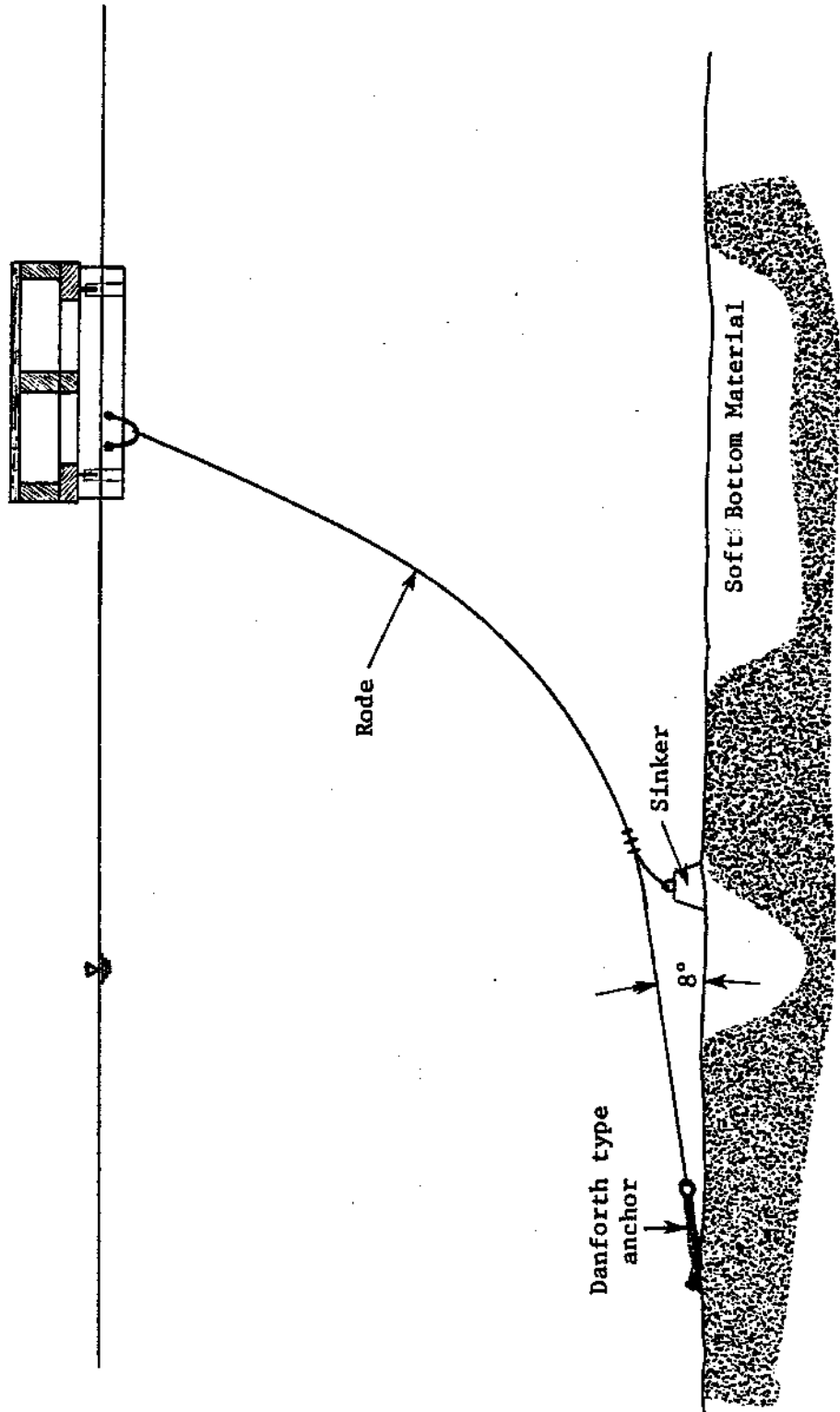

Figure 7.27 Cable Anchoring of a Floating Dock

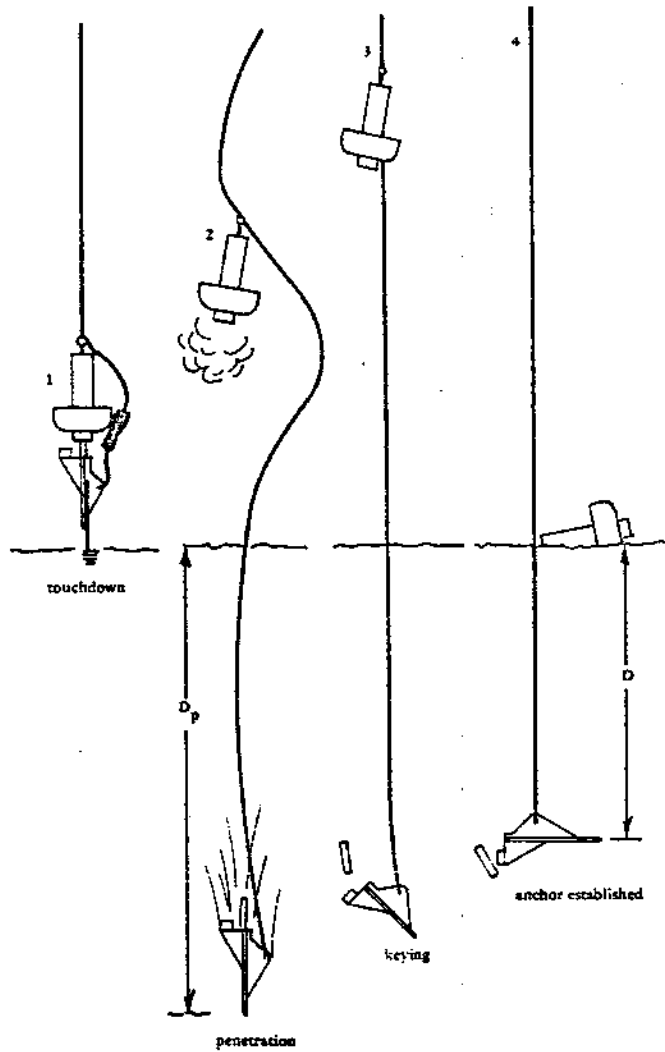

Figure 7.28 Penetration and Keying of a Propellant-Embedded Anchor (Beard, 1980, p. 6)

in calm areas when the number of piles required is not too great. According to Dunham and Finn (1974), however, it is more common to use some other anchorage system such as a pile dolphin. Dolphins derive their strength by acting as a braced A-frame instead of through cantilever bending. Since a single dolphin may have the strength of 10 to 20 individual guide piles, fewer are needed (Dunham and Finn, 1974). The dolphins are then located at strategic points beneath the cover, and the structural framework of the roof is used to transmit the lateral loads. Submerged cross ties (Figure 7.29) may be used to strengthen the system further if the water is deep enough.

7.8 SUMMARY

Floating docks seem to be the most popular structural type in new marina projects. Their attributes include reasonable cost, neat appearance, and ease of access to berthed craft. The structural geometry of floating docks is very similar to fixed docks with the major exception that they rely on pontoons for vertical support instead of piles.

These pontoons include coated lightweight foam blocks, and shells made of molded synthetics, metal, and concrete. Virtually all of these shells are now filled with foam cores to minimize problems with internal deterioration, leaking, and vandalism. The selection of float material is based on availability, durability, stability, and cost. Except as a temporary float, oil drums and unprotected foam blocks are not recommended.

The design considerations relating to the components of the floating dock system have been presented in this chapter. These components include pontoons, stringers and walers, bracing, connections, fenders, and gangways. Lateral restraint of float systems is provided by anchorage

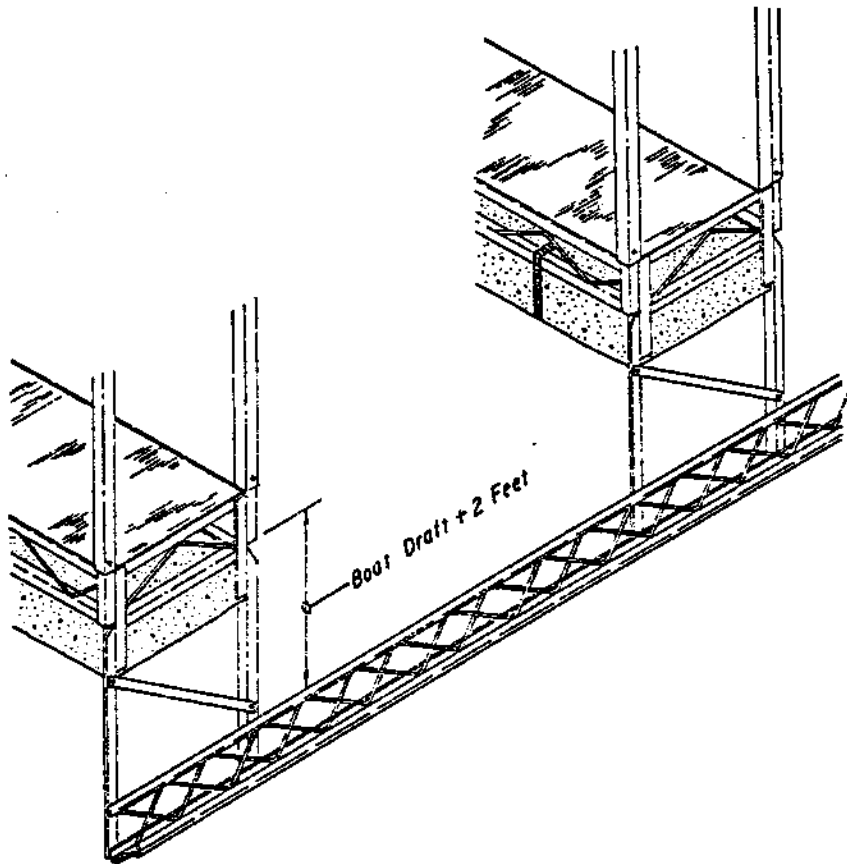

Figure 7.29 Submerged Crossties (Dunham and Finn, 1974, p. 145)

systems. There are two general categories of anchorage including fixed support or guide pile systems, and flexible support or cable anchorage.

CHAPTER 8

UTILITIES AND SPECIAL SERVICES

Utilities are an essential part of the successful modern marina. According to Dunham (1969) the marina should be provided with all the utilities called for in any standard community development. For the purposes of this report, utilities are taken to be the services commonly supplied to the public by a municipal system. These services include electrical power, sewage disposal, telephone communications, and freshwater. Most marinas do not provide telephone connections to the berth and instead combine the telephone service with the public address as a subset of the electrical service. The most important special services of a marina with respect to dock, pier, and wharf systems are fire fighting facilities and the fuel dock.

For proper performance, utility sizing, location, design and construction should conform to methods of accepted practice. This chapter is intended to stress the practical aspects of utility design to insure that the designer does not overlook any of the key items peculiar to the marine environment. Utility subsystems must not be considered "add-ons," but instead should be integrated into the dock design from the planning stage. In addition to accepted practice, however, utilities must also conform to applicable codes. Local regulations are only the first step, as Blanton (1979) notes that many local agencies are not familiar with marina design. To protect against liability, the marina owner/builder should meet national standards as well, providing they are representative of accepted good practice.

While there are some areas of overlap, the electrical, sewage,

water, fire and fuel services are addressed separately in the following pages. The codes or regulations pertaining to each are presented, followed by the design considerations and location details that define accepted good practice.

8.1 ELECTRICAL SERVICE

The electrical system for a dock facility provides support for the slips, dock lights and a communication network. It may well be the most critical of marina utilities for the following reason. While a leaky water or sanitary system is an inconvenience and a health hazard, a leaky electrical system is potentially deadly. Fatal accidents that occur when a well-grounded person (water is an excellent ground) contacts a live electrical circuit are all too common. In the case of the electrical service for docks, piers, and wharves, these accidents can be avoided through attention to design details, and adherence to appropriate codes.

Regulations

While it is recommended that a competent electrical engineer be consulted to design the electrical system of any large marina (Dunham and Finn, 1974), owners of smaller operations may obtain construction permits to allow them to do the work themselves. Their work is then subject to local inspection to see that it satisfies both local and national electrical codes. The State of California (1980) recommends using the more conservative code in case of a conflict.

In the marina environment, only codes for outdoor or damp locations are appropriate. The National Electrical Code (National Fire Protection Association, 1980) is generally accepted as the national code of record for electrical systems not controlled and

maintained by the public utilities (Bernstein, 1979). According to Bernstein (1979), this code has no basis in law unless it is adopted by local jurisdictions. The Code is prepared and revised every three years by the National Fire Protection Association with the latest revision being the 1981 edition. Article 555 of the National Electrical Code is of primary interest since it applies to marinas and boat yards. Two other relevant publications are the "National Electrical Code Handbook" (McPartland, McPartland and McPartland, 1981) and the "Fire Protection Standard for Marinas and Boatyards" (NFPA 303-1975). While the Handbook is based on the current National Electrical Code, it provides additional discussion and illustrations to clarify ambiguous sections. Chapter 5 of the National Fire Protection Association Standard 303-1975 presents information pertaining strictly to marina electrical systems.

Electrical System and Outlets

The general purpose electrical system used throughout the United States is the single phase, alternating current, 120/240V, 60 Hz system. 240V, 50 Hz is the electrical standard in Europe. A two-wire cable is used to transmit 120V while a three-wire cable is used for 240V service. The 240V service is preferred when transmitting over long distances because less energy is lost for a given conductor size, and smaller, lighter conductors may be used.

Power outlets are installed at each berth in a dock system as a convenience to the slip renter. Power demand will vary from 20-50 amperes per slip depending on the geographic location and the type

of boat in the berth (Dunham and Finn, 1974). Boat owners in colder areas often use small electric heaters to keep craft warm and dry, thereby using more power (Treadwell and Kycek, 1971). A minimum service of 20 Amperes is recommended by Dunham (1969) while a more recent source (State of California, 1980) suggests 120V/30A service for berths less than 50 ft (15.2 m) and 120V/50A service for berths greater than 50 ft (15.2 m). In the latter case, the boat manufacturers should be consulted since these larger craft may require 240V service (Dunham and Finn, 1974). The outlet selected for installation at a slip should be non-corrosive and waterproof, but not so shielded that the standard twist-lock plugs are hard to insert. Riser racks and locker boxes provide well protected and convenient outlet locations. In the interests of safety, outlets should be located such that an extension cord running to the boat in a berth will not cross a main walkway (State of California, 1980). In place of a fuse or circuit breaker, a ground fault circuit interrupter (GFCI) should be installed to protect each outlet. The GFCI acts both as a conventional circuit breaker and as protection against an accidental low current to a ground outside the circuit (Bernstein, 1979). Since the installation of meters at each slip is considered impractical (Treadwell and Kycek, 1971), the cost of unmetered electrical service should be included in slip rental fees. The charges should then be based on GFCI rating and average usage (Dunham, 1969).

Lighting

Dock lighting systems perform two important functions by providing safe access to berthed craft at night, and protecting these craft

and the harbor facilities in general from vandalism. While they may aid an incoming craft in locating the docks from the water, navigation and channel markers are usually furnished for that purpose. Dock lights are typically set on standards 8 to 12 ft (2.4 to 3.7 m) tall (Chaney, 1961). Some authorities, however, permit only low level (30 in. or 0.76 m above deck) lighting (Dunham, 1969). Lights must be carefully designed to provide uniform intensity over the dock without excessive glare on the water which could interfere with night-time navigation. Chaney (1961) recommends a minimum light intensity of 0.5 ft-candle and suggests that 300 watt lights, set on standards 10 ft (3 m) high and spaced 75 ft (22.9 m) apart, should be sufficient. A separate circuit should be used for dock lights, with switches located in the administrators office to control each pier independently. Red colored lights should be used to identify fire fighting equipment.

Communications

The communication systems used in marinas may range from a simple public address system to phone jacks installed at each pier. Communication lines carry very little current and are necessarily a separate circuit from lights or power outlets. Unlike lighting or power circuits, however, they can be installed after the berthing system is in service without much difficulty.

Conduit and Circuit Design Considerations

Shoreside utility lines are almost always buried. Over-the-water electrical lines may either be run overhead on insulated supports, or in conduits under the deck. Overhead lines are less

costly to install and repair, but they are unsightly. On the other hand, under deck wiring must be encased in waterproof conduits to minimize damage in case of flooding. While the under deck location is more expensive, it provides good protection for the wires and is more attractive (Chaney, 1961). Electrical conduits should be non-corrosive, waterproof, and located for ease of repair (Dunham and Finn, 1974). They should also be large enough in diameter so that the wires are easily "fished" through them without sticking. Common locations for conduits are in a covered utility trough down the center of the deck, a central chase with pull-boxes, or hung under the walers on the outside of the structure (Figure 8.1). Curry (1979) states that deck troughs are the "best solution" and are worth the extra cost. Grounding plates that hang in the water have been used in the past to avoid running a ground wire back to a suitable land ground. These should be avoided since they may cause electrical currents in the water that damage propellers and other metal parts (Dunham, 1969).

Conductor size is one of the most important aspects of electrical circuit design. Conductors that are too large are needlessly expensive while undersized conductors are a potential fire hazard. Conductor size depends on the electrical load it must carry (measured in amperes), the circuit length, and the allowable energy losses. The National Electrical Code (National Fire Protection Association, 1980) and Wiring Simplified (Richter, 1977) are recommended references for the design of marina electrical systems (Bernstein, 1979).

8.2 SEWAGE PUMPOUT AND DISPOSAL SERVICE

Sewage pollution in the marina has been called a "topic suffering

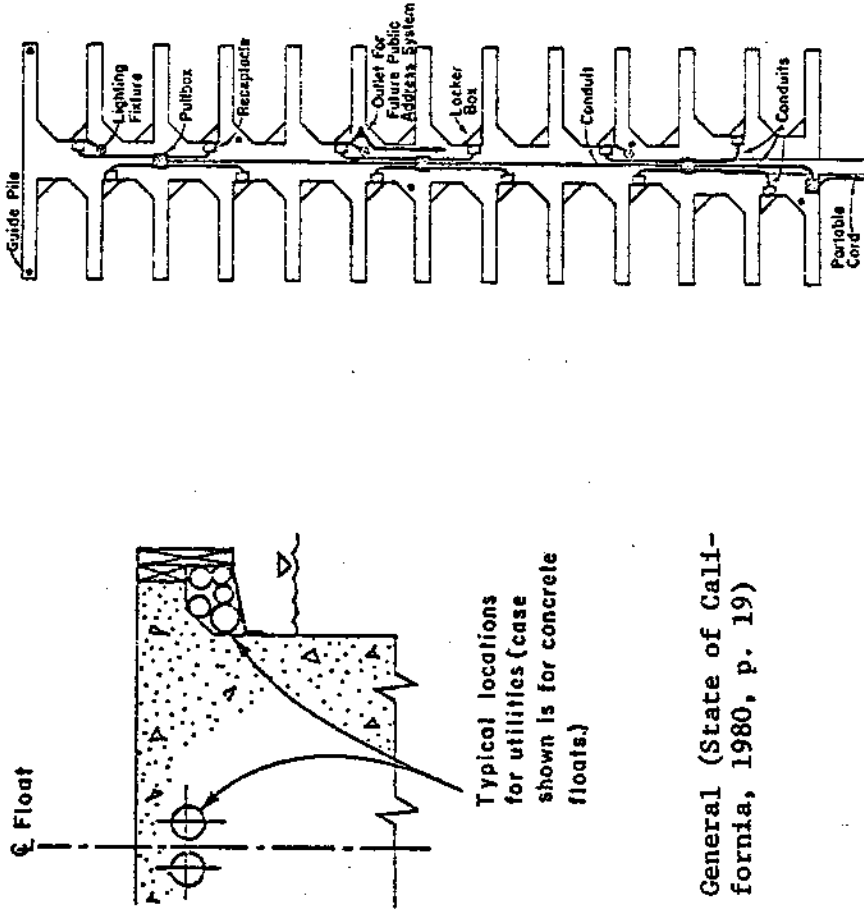

A. General (State of California, 1980, p. 19)

B. Electrical Plan (Dunham, 1969, p. 123)

Figure 8.1 Location of Electrical Utilities

from overkill" (Ross, 1976) and "the greatest non-issue that has ever been raised" (Chamberlain, 1979). Theoretically, small-craft could cause a serious pollution problem by discharging toilets or "heads" within the confines of the marina, thereby raising the level of fecal coliforms and the potential for disease carrying pathogens (Chmura and Ross, 1978). In fact, recreational marinas are little more than parking lots for empty boats, and when these boats are in use (i.e., engines running and toilets flushing), they are out of the marina and their pollutants are dispersed in ratios of billions-to-one (Ross, 1976). Nixon, Oviatt and Northby (1973) report that with respect to raw sewage from pleasure craft, "No impact on the marinas could be detected". Cited as evidence is the case of the city of Newport Beach, California, where water samples are taken twice a week, year-round. While its harbor accommodates 8,000 pleasure craft, the beaches have never been closed because of boat sewage. Nixon, Oviatt and Northby also state that in some areas the background levels of coliforms resulting from land-based sewage input were so high that no boat-related impact could be detected.

For better or worse, environmentalists and concerned health officials have lobbied for and achieved regulations requiring contained systems or chemical toilets. Contained systems require support facilities to remove and dispose of the wastes they collect. Chemical toilets release physically and chemically treated sewage, and according to Chmura and Ross (1978), the environmental impact of the chemicals used may be more harmful than raw sewage. Chamberlain (1979) suggests that the sewage problem should be a part of site evaluation since marinas may be required to meet water quality standards that are not

achievable because of existing problems. The discussion that follows presents the marina designer with the regulations that pertain to sewage pumpout facilities, design considerations concerning the facilities themselves, and finally factors affecting the recommended location of such facilities.

Regulations

On the federal level, the Coast Guard and the Environmental Protection Agency now require that boats with permanently installed toilet facilities be equipped with marine sanitation devices (Chmura and Ross, 1978). These marine sanitation devices (MSD's) are separated into three type categories. Type III devices are designed to prevent any discharge of sewage (i.e., holding tanks) and are required on inland waters since these waters are used for drinking supplies. Chemical toilets (Type I and II MSD) are required on marine and navigable waters. The treated sewage released by these toilets must meet state and local water quality regulations as well as the Department of Interior Federal Water Pollution Control Administration standards (Quinn, 1972). As a result of these stringent requirements, the modern marina must provide pumpout facilities to handle and dispose of waste from boats. Chmura and Ross (1978) report that such facilities are very limited and marina operators should be encouraged to provide more of them. A minimum of one shoreside pumpout station is recommended for each marina (State of California, 1980).

Pumpout and Disposal Systems

The marina planner has a number of options concerning the sewage

pumpout system that should be installed, including no facility, a portable pumpout unit, or a fixed station (Blanton, 1979). The decision regarding which system to install should be based on applicable regulations, the installation cost, and the expected demand. If a nearby pumpout facility exists that is underutilized, marina customers can be saved a substantial sum of money in slip rental fees with little inconvenience by opting for no installation. In low demand areas a portable system may be acceptable if the marina can get the local septic service to pump it out on short notice. For heavier demand, a fixed system with an in-the-ground holding tank is recommended (Blanton, 1979).

Sewage pumpout facilities should include equipment to pump or receive and transfer the contents of holding tanks into a sewage retention and disposal system (State of California, 1980). The components required for such a system include a freshwater pressure line and hose, a suction hose, a sludge pump, a discharge pipe, and a shoreside holding tank. The freshwater pressure line and hose are provided for flushing the boat holding tank after pumpout. The State of California (1980) recommends that no domestic water outlets be located near the pumpout station, and that a sign reading "Not for Human Consumption" be posted conspicuously. The pump unit and all associated electrical fixtures must be explosion proof because of methane gas produced by the sewage (Blanton, 1979). The discharge line should be as short as possible, sloped toward shore 1 in. (25.4 mm) in 100 ft (30 m), and fitted with shut-off valves and drains. The last item is necessary for "blowing out" the lines to clean them and to avoid freezing in

cold climates (Blanton, 1979). Holding tanks are usually made of concrete, but properly protected steel tanks are acceptable. Because sewage can be very corrosive, coatings inside and out are required (Commonwealth of Virginia, 1976). Since these tanks must be installed at or below the level of ground water, they must be waterproof and restrained against floating. Holding tank design with respect to size depends on its intended use. If shoreside wastes are to be combined with boat sewage in the holding tank, it must be much larger. Tank size may be specified in health codes according to boat size. Blanton (1979) cautions that these figures represent the "maximum" that should be considered for a first class installation, and that experience indicates that tanks sized for half the specified load will provide years of trouble-free service.

The method of disposal of boat sewage depends primarily on the location of the marina. Because the marina is necessarily situated on the waterfront, it is usually not near a public sewer line, and the water table often lies so near the surface that a septic system and drain field is not effective (Ross, 1976). If a public sewer line is accessible, it must be determined if the marina is far enough "upstream" of the treatment plant so that its biological systems are not decimated by a concentrated dose of toxic chemicals from treated boat sewage. Blanton (1979) suggests that the best solution is to pay the local "Port-a-John" man to dispose of the wastes in the proper manner. He will have both the experience of handling treated wastes, and a permit to dump into the public sewer at a point far enough from the processing plant that the toxic materials become diluted. Chamber-

lain (1979) notes that in remote locations, marinas have the option of installing packaged sewage treatment plants, but states that proper sizing is a critical design parameter. If such systems are overdesigned, there may not be sufficient sewage inflow to make the biological processes self-sustaining.

Location of Sewage Pumpout Facilities

The location of the pumpout station should be convenient to the customer while keeping the line to shore as short as possible (Blanton, 1979). Depth of water and maneuvering room are important since it is predominantly the larger craft that use the pumpout facility. The State of California (1980) suggests that it is advantageous to have the fuel pumps and sewage pumpout adjacent to each other. The shoreside end of the fuel dock is a location that satisfies all these requirements as well as allowing the fueling attendant to supervise holding tank discharge.

Location is not an element of design for portable pumpout units since they are intended to be taken to the craft to be serviced. A protected storage place is necessary however.

Currently there is little need for direct connection sanitary systems to service boats in their berths (Dunahm and Finn, 1974). Such service would be convenient for boaters that live aboard their craft, but it requires adding another utility line.

8.3 FRESH WATER SERVICE

In addition to electrical and sewage services, fresh water is often supplied by a public utility. It is commonly piped to the slips of the modern marina for drinking, filling fresh water holding tanks,

and for washing boats (Dunham and Finn, 1974). Because water is used for human consumption, the piping system must be sanitary and the water must be potable. In a small dock system, the freshwater line may also serve as a fire fighting device. Fire fighting facilities are discussed subsequently. The regulatory standards, system design considerations, and the location details that pertain to freshwater systems are described below.

Regulations

Regulations concerning water services fall into three groups: plumbing, health and safety. The Basic Plumbing Code (BOCA, 1978) is the National standard on plumbing. Some mention of freshwater systems will be made in State health standards since water is used for human consumption. All contact between the water and sewage systems must be avoided to guard against contamination. A newly installed freshwater system must also be completely disinfected before it is put into service (Blanton, 1979). Safety regulations concern the use of the freshwater system for fire prevention and control.

Design Considerations for Freshwater Systems

The typical freshwater system for a dock starts at the shoreside manifold. Water is carried by pipes out along the main walks to hose bibbs or risers installed at each slip. Dunham and Finn (1974) state that water is usually provided free to slip renters, and therefore only one meter is required for the marina. Blanton (1979) suggests that water going to the dock system be metered separately to avoid overcharging by the sewage treatment plant. Sewage treatment fees are often proportioned to the water bill, and water to the docks usually will not go into the sewer.

The pipeline is the main component of the freshwater system. While acceptable materials for the pipe include copper, galvanized iron, and polyvinylchloride (PVC) plastic, each has its disadvantages. Copper pipe with silver-soldered joints is good in all locations, but it has become very expensive (Blanton, 1979). Galvanized iron tends to have a shorter life span and it corrodes at the joints if not properly coated and maintained (Dunham and Finn, 1974). PVC plastic is especially good for saltwater marinas since it is non-corrosive. Because it is easily damaged, and becomes brittle in cold weather, Dunham and Finn (1974) recommend that PVC not be used for exposed risers. Translucent plastics should be avoided as light will encourage algae growth within the pipe (Bertlin, 1976). The low flexural rigidity of PVC favors it in pipe selection for floating docks since it conforms to the float displacements more easily than copper or galvanized iron (Dunham, 1969). The joints, fittings, and pipe support system require special attention in a floating system to avoid fatigue failure. With regard to pipe supports or hangars, copper or galvanized iron pipes must be isolated from dissimilar metals to prevent electrolytic corrosion.

Pipe line diameter depends on the demand from the berths, and whether the system is used for fire fighting. Blanton (1970) suggests that in the absence of legal requirements, a 0.75 in. (19 mm) line will serve 20 berths, a 1 in. (25 mm) for 40 berths, 1.25 in. (32 mm) for 60 berths, 1.5 in (38 mm) for nearly 100 berths, and 2 in. (51 mm) for 200 berths. For proper performance of the water system, the pipe should be designed and sized such that a minimum pressure of 25 psi (172 kN/m^2) occurs at the most distant outlet in the system under peak demand (State of California, 1980). A 2 in. (51 mm) pipe size will satisfy national fire

regulations and it could serve to distribute water to the slips as well as fire fighting stations.

Expansion and contraction of the pipe should also be addressed by the designer (Chaney, 1961). Temperature changes of 130°F (54°C) seasonally and 50-60°F (10-15°C) in minutes (as cold water runs through warm pipes) can cause damaging stresses unless expansion units are provided. On long straight runs of pipe, long radius pipe bends or slip joints should be installed not more than 140 ft (46 m) apart (Chaney, 1961).

The shoreside end of the freshwater pipe should be protected by a backflow preventer and shut-off valve at each pier (Blanton, 1979). In cold climates, the shut-off valve is best located where it will not freeze. The pipe is then sloped toward shore and provided with drains and air blow-out taps to avoid ice damage. Note that expansion bends must be laid flat so that drainage is not impeded. Blanton (1979) indicates that a slope of 1 in. (25 mm) in 100 ft (30.5 m) is sufficient for proper drainage. In the case of a floating dock, special attention must be given to the shore-float connection to assure flexibility and fatigue resistance. The shore and float pipes should end in down-turned elbows that are connected with a U-shaped flexible hose (Dunham and Finn, 1974). The slip end of the water pipe consists of a riser-rack or hose bibb. One standard (0.75 in. or 19 mm) hose rack is recommended for every two berths (State of California, 1980). If unprotected risers are used, they should extend no more than 1 ft (0.3 m) above deck level (Dunham, 1969). Thread-on fittings and valves are recommended by Dunham and Finn (1974) since they are easier to maintain and replace.

Location of Freshwater Service

Water lines are often hung from the timber walers that protect most docks from boat impact. While this location is convenient in terms of initial installation, the utilities are subject to mechanical damage from boats. Locating the pipes behind the deck stringers insures that they cannot be hooked or used to tie-off boats, but it creates maintenance problems. Curry (1979) suggests that deck troughs are the best solution and are worth the extra cost. Hose bibbs are often located on the knee that forms the junction between the main walk and each finger pier (Figure 8.2). They are usually combined with the electrical outlets that service each slip, and are often mounted on locker boxes or strapped to piles. Care should be taken to avoid placing hose bibbs where they can drip on pressure treated walers and cause decay problems (Curry, 1979).

8.4 FIRE FIGHTING SERVICES

While marina fires occur infrequently according to Blanton (1979), the situation is potentially catastrophic. Many of the materials used in both boat and dock construction are flammable, not to mention the presence of gasoline and oil. If a fire starts on the upwind side of a harbor, a strong breeze can quickly carry it from slip to slip and along the docks. The spread of fire is even faster in covered sheds where access is more difficult. Some form of fire fighting equipment must be provided by the marina to minimize damage and protect against liability. Outlined in the following discussion are the regulations and design considerations relating to fire fighting equipment for docks, piers, and wharves.

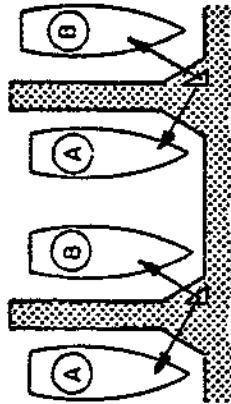

A. Typical Water Service Arrangement for Double Berths (State of California, 1980, p. 19)

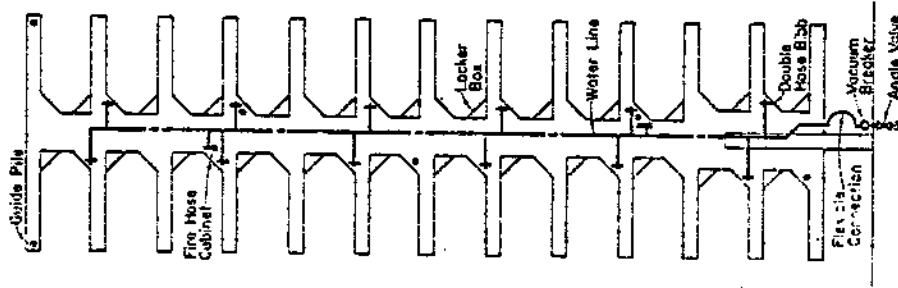

B. Water Piping Plan (Dunham, 1969, p. 123)

Figure 8.2 Location of Fresh Water Service

Regulations

The National guideline of record is "Marinas and Boatyards" (National Fire Protection Association, 1975). Other regulations written by the National Fire Protection Association include:

1. Fire Prevention Code, 1975
2. Sprinkler Systems, 1980
3. Centrifugal Fire Pumps, 1974
4. Extinguishers, Installation and Maintenance, 1974
5. Fire Hydrants, 1974
6. Standpipe and Hose Systems, 1980
7. Flammable Liquids Code, 1973
8. Outside Protection, 1977

Local regulatory agencies have specific requirements for marinas, but in case of a liability suit, the marina owner may also be held to the stricter national standards (Blanton, 1979).

Fire Fighting Equipment

Preliminary to a discussion of fire fighting equipment, some mention of the type of fire to be fought is necessary. Fires are classified A through D according to the type of fuel (Texas A & M, 1971). Class A fires are ordinary combustibles such as wood and are usually fought with water. Class B fires consume substances such as gasoline, oil, tar and grease. Live electrical fires are considered Class C fires and require a non-conductive extinguishing agent. Class D fires are not a problem in the marina since they are caused by combustible metals such as magnesium and sodium which are unstable in the atmosphere and do not exist in a pure state in nature.

The method of fighting fires varies with the type of fire and the extinguishing agent used. Water, foam, carbon dioxide (CO₂) and dry chemicals are the standard fire fighting agents. Water is the most

common substance used because of its availability and low cost. Usually in the form of fog, water is used on Class A fires where it acts to cool the fire, displace available oxygen, and dilute the combustible vapors. Foams are used on Class A and B fires but, according to Texas A & M (1971), they do not work well on flowing liquids or at low temperatures (less than 10°F or -12°C). Carbon dioxide (CO₂) extinguishes by smothering a fire and reducing the available oxygen to a non-combustible level. CO₂ may be used on all fire types, but its effectiveness is greatly reduced by winds. Finally, dry chemical extinguishers are used on all B and C class fires, but they leave behind a residue that may damage electrical equipment.

Marina fire fighting facilities typically consist of a water system supplemented by small dry chemical extinguishers, and a large CO₂ extinguisher on wheels. Chaney (1961) writes that the greatest cause of fires in the marina is the ignition of gas and oils by faulty electrical equipment. The fuel dock satisfies these conditions and requires the Class B and C fire fighting agents (dry chemical and CO₂). A water system is necessary at the fuel dock and throughout the berthing system to prevent the spread of fire and protect the berthed craft (Blanton, 1979). For small dock systems, the freshwater system may be used for fire protection (Dunham and Finn, 1974). Since fire regulations usually require a supply line of at least 2 in. (51 mm) diameter, it is advantageous to install separate systems. Blanton (1979) states that some marinas provide a hydrant at the foot of every pier, with a 2 in. (51 mm) line running out the pier to 1.5 in. (38 mm) hose connections and hoses on 75 ft (23 m) intervals. The pier line is connected to the hydrant by a 2.5 in. (63.5 mm) hose adapter. This system is in com-

pliance with NFPA-303 "Marinas and Boatyards", but is expensive and may not be required by local laws. It does have the advantage of keeping the pier line dry to prevent damage in freezing weather. Dunham (1969) and Dunham and Finn (1974) recommend 75 ft (23 m) of 1.5 in. (38 mm) hose on racks spaced 100 ft (30 m) apart, while the State of California (1980) suggests 150 ft (46 m) intervals. The 75 ft (23 m) and 100 ft (30 m) spacings provide some overlap that allows the use of two hoses simultaneously on one spot while the 150 ft (46 m) spacing does not. Dunham (1969) suggests that the water pressure at the outboard hydrant be no less than 25 psi (172 kN/m²) with two intermediate hoses operating, while the State of California (1980) recommends water be supplied at a rate of 20 gpm (76 l/m) and a minimum pressure of 20 psi (138 kN/m²). Water used for fire fighting should be clean and fresh if possible to minimize corrosion damage after a fire.

In addition to the water system, fire extinguishers are provided throughout the marina. Bertlin (1976) suggests that two dry powder extinguishers (10 lb or 5 kg) be located on each pier in cabinets with break-glass access. Many marinas hang extinguishers on unprotected brackets every 50 ft (15.2 m) but theft and vandalism is a serious problem (Blanton, 1979). A large (40 to 300 lb or 220 to 662 kg) CO₂ extinguisher on a cart is recommended by Quinn (1972) and Blanton (1979) for use on the fuel dock.

Municipal Fire Departments

If within the protection of a local municipal fire department, the marina owner should arrange for their services (State of California, 1980). The fire department can provide major fire fighting capabilities and

experience that marina personnel lack. To obtain the best service from the fire department, ready access to the site must be provided as well as hose connections compatible with their equipment. A fire department near the waterfront may have a fire boat to fight fires that are inaccessible from the shore side. Some marinas choose to outfit boats with fire pumps so that they are readily available (Blanton, 1979).

8.5 FUELING SERVICES

Nearly all craft including most sailboats have need of fuel and oil for their engines. It is recommended by Dunham (1969) that every harbor have at least one marine service station. In lieu of an internal fuel dock, one that is external to the harbor but nearby may be satisfactory. An internal fuel dock that is properly designed and operated will produce revenues through its fuel sales as well as by attracting slip renters. The simplest solution to providing fueling facilities for a marina is to lease the privilege to an oil company to develop and operate. According to Dunham (1969), this is the case for most large fueling stations. Fueling facilities for smaller operations may be developed by the owner with some assistance. A competent mechanical engineer, preferably one specializing in piping, is recommended by Blanton (1979). The following discussion presents regulations applicable to fueling facilities, guidelines for design of the fuel dock, and its location within the marina.

Regulations

Fueling facilities are potentially very dangerous. Risk can be minimized through proper operating procedures and safe construction practices as specified by local and national regulations. The "Flammable and

Combustible Liquids Code" (NFPA 30-1981) and the "Underground Leakage, Flammable Liquids Tanks" (NFPA 329-1977), published by the National Fire Protection Association, should be consulted, along with the latest published regulations of the National Board of Fire Underwriters.

Fuel Dock

The fuel dock is similar in most respects to a dock designed for berthing. In the absence of code specifications, fuel docks may be fixed or floating. Some codes require that the fuel dock be on solid ground or a fixed pier (Dunham, 1969). A floating dock is preferred by both users and operators since it minimizes differential movement between the boat and dock, making the fueling operation much easier. The fuel dock must be more rugged and stable than the common berth structure (Dunham and Finn, 1974). While fixed docks present no problems with regard to stability, floating docks must be "beefed-up" structurally with added flotation to support the weight of the fuel dispensing equipment and supplies. Flexible connections must be provided at each joint between floats and between the dock and shore (Dunham and Finn, 1974).

Fuel is generally stored on land in buried, tar-covered steel tanks (Chaney, 1961). Fuel tanks placed above ground are unsightly, an increased fire hazard, and an insurance liability. The tanks should be installed far enough behind the bulkhead line so that a bulkhead failure will not cause the tank to move, possibly resulting in an underground fuel leak (Blanton, 1979). Blanton (1979) also notes that in areas of high ground water, fuel tanks must be anchored down to restrain them from "floating" as they are emptied. Tanks should have at least 2 ft (0.6 m)

of soil cover and should be vented to a point 10 to 12 ft (3.0 to 3.7 m) above ground level (Chaney, 1961).

The pipeline transporting fuel from the tank to the pump starts with a foot valve in the tank that should be removable for cleaning (Chaney, 1961). To minimize fuel spill in case of pipe rupture, an anti-siphon check valve should be installed where the pipeline passes below the elevation of the tank top, and shut-off valves should be installed on both sides of flexible couplings (Blanton, 1979). Chaney (1961) suggests that the fuel system be air-pressure tested before it is put into service to check for leaks. Fuel line size can be determined from the pumping rate and the number of boats to be serviced simultaneously. Chamberlain (1979) recommends 2 sets of metered, automotive type pumps with 25 ft (7.6 m) hoses so that several craft can be fueled at once.

The area around the dispenser is classified as hazardous by the National Electrical Code (NFPA, 1980) and requires special wiring, switches, and other fixtures. All electrical equipment must be of the explosion-proof type. Automatic nozzles with latch-open devices should be avoided because they encourage spillage (Blanton, 1979). The nozzles should be grounded to shore, and ground bars with cables and clips should be provided for static discharge of fuel tanks (Chaney, 1961).

Some special attention must be given to the materials used in fuel docks. A resistant float material is to be preferred over unprotected polystyrene since it is subject to degradation by hydrocarbons. Concrete decks are an improvement over timber decking as the latter material will soak up fuel and oil and become an increased fire hazard.

Signs should be posted in conspicuous places to warn against smoking, running the engines, or using electrical equipment during the fueling operation (Blanton, 1979).

Fuel Dock Location

The location of a fuel dock within a marina is somewhat of a dilemma. It is advantageous to have the fueling facility near the entrance of the harbor to avoid problems with traffic, wake or fire hazard. On the other hand, a distant fuel dock requires lengthy utility and fuel lines. It is more expensive to install and may be a long walk from the administrative office so that it is hard to run at a profit (Chamberlain, 1979). Blanton (1979) suggests that risk can be minimized by locating the fueling facility away from restaurants, fishing piers, and other such gathering places. The fuel dock should be readily accessible with a minimum of travel through the berths, as well as isolated from the berths so fire and explosions cannot spread and damage other craft (State of California, 1980). Chamberlain (1979) proposes two locations for the fuel dock: the first being a short pier perpendicular to the shoreline near the marina office, and the second location being an enlarged "T" head on a central berthing pier (Figure 8.3). In the first case, turning lanes must be provided on either side of the fuel dock that result in wide fairways. A "T" head pier must be large and strong to support a light vehicle such as a golf cart, and possibly a pier-head store. In either case, a minimum of 200 ft (61 m) of clear pier with space and cleats for temporary tie-ups is recommended (Chamberlain, 1979). The fuel dock is also a good location for sewage-pumpout facilities (State of California, 1980).

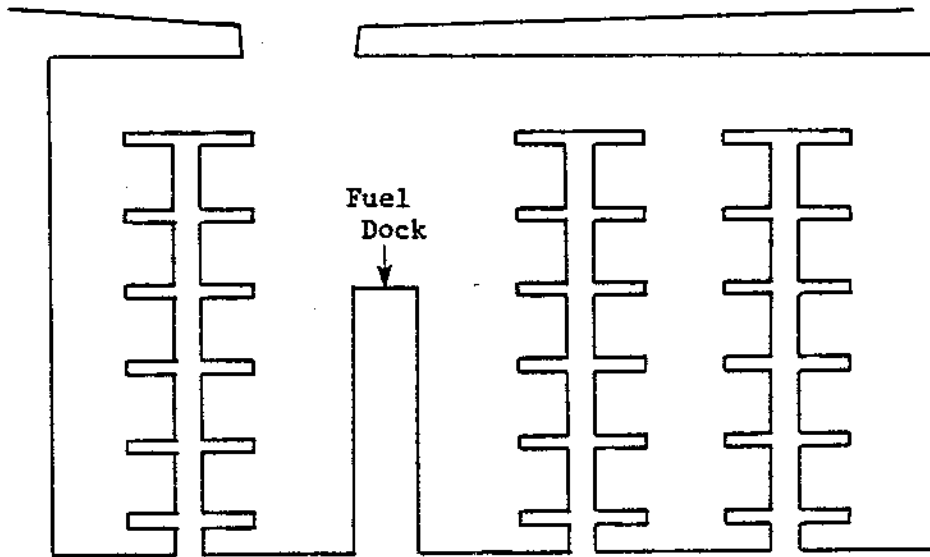

A. Short, Shoreside Fuel Dock

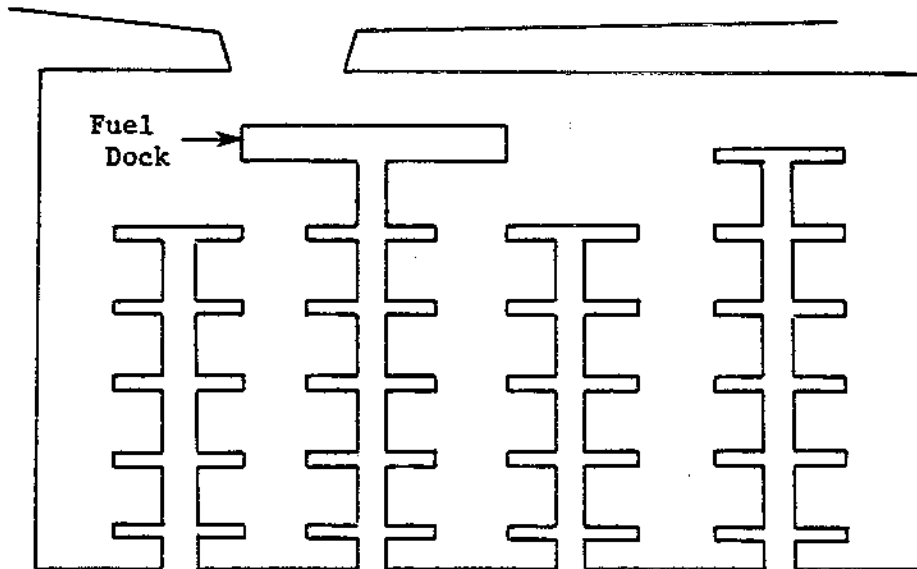

B. Enlarged "T" Head Fuel Dock

Figure 8.3 Fuel Dock Locations (After Chamberlain, 1979, p. 23)

8.6 SUMMARY

Utilities include electrical power, freshwater, sewage disposal, and telephone connections. Special services include fire fighting facilities and a refueling station. These utility and special services are an essential part of a modern marina.

As such an important convenience to the marina patron, utilities must not be considered add-on systems but instead should be integrated with dock design to assure smooth operation. The design of all these systems is subject to the regulations and specifications on the federal, state, and local level of government and industry. Unfortunately, many of these specifications and controls are written by committees unfamiliar with design in the waterfront environment. It is therefore recommended that national standards be met as long as they are representative of accepted good practice.

The electrical service consists of an outlet at each slip using a waterproof twist-lock receptacle protected by a ground fault circuit interrupter. The electrical service is also used to power flood lights to illuminate the berthing area at night. Typical sewage facilities consist of a pumpout station that transports treated boat wastes to a holding tank for shoreside disposal. A common location for the pumpout station is on the end of the fuel dock. Freshwater is supplied to berths through hose bibbs located at the finger pier-main walkway connection. Freshwater supplies may also be combined with fire fighting pipelines in addition to dry chemical and carbon dioxide extinguishers. The fuel dock dispenses petroleum products to power boats. For safety reasons it should be located away from the berthing area in case of fire.

CHAPTER 9

DREDGING FOR SMALL CRAFT HARBORS

Dredging may be defined as the removal of submerged material by hydraulic or mechanical means (Schubel, Wise and Schoof, 1979). The materials removed may range from rock and sunken debris to fine-grained sediments. Dredging is performed either to create and maintain a waterway, or to "mine" the bottom material for commercial purposes. This chapter concentrates on the waterway and small craft harbor related aspects of dredging. The four main topics that will be addressed are dredging methods and equipment, when dredging is required, dredge materials and their disposal, and the environmental impacts of dredging. Dredging problems will also be discussed briefly.

9.1 METHODS AND EQUIPMENT

Dredging methods may be separated into two categories: hydraulic and mechanical. For either method, the function of the dredge is to raise material from the bottom of a body of water (usually to some point above the surface), and then dispose of it. Mechanical dredges excavate this material by means of buckets or scoops while hydraulic dredges must reduce the material to a slurry so that it can be pumped. The most common types of hydraulic and mechanical dredges, and their operating characteristics were presented by Mohr in 1974 (Table 9.1).

While the basic types of dredges have not changed much since the 1950's, general dredge modernization has been accompanied by a gradual increase in size. Modern dredges are somewhat difficult to classify (as in Table 9.1) since they are often custom designed for a specific purpose and may combine several components. In a recent review

Table 9.1 Mechanical Dredges (Mohr, 1974, pp. 70, 71)









Dredge type (1)	Dragline on barge (2)	Dipper dredge (3)	Clam shell or orange peel bucket dredge (4)	endless chain bucket dredge (5)
Dredging principle	Scrapes off material by pulling single bucket over it toward stationary crane. Lifts bucket and deposits dredged material in a conveyance or on a bank.	Breaks off material by forcing cutting edge of single shovel into it while dredge is stationary. Lifts dredged material in a shovel and deposits dredged material in a conveyance or on a bank.	Removes material by forcing opposing bucket edges into it while dredge is stationary. Lifts bucket and deposits dredged material in a conveyance or on a bank.	Removes material by forcing single cutting edge of successive buckets into material while dredge is slowly moved between anchors. Lifts buckets and deposits dredged material in a barge or own hopper.
Horizontal working force on dredge	Medium intermittent force toward bucket.	High very intermittent force away from bucket.	No forces.	Medium constant force away from bucket.
Anchoring while working	Dragline crane can be on shore or on barge. If on barge, latter can be secured with spuds or anchors.	Several heavy spuds.	Several spuds or anchors.	Several anchors.
Effect of swells and waves	Can work up to moderate swells and waves	Very sensitive to swells and waves.	Can work up to moderate swells and waves.	Very sensitive to swells and waves.
Material transport	Transport occurs in barges, trucks, or cars. Crane does not transport material. Material disposal occurs in many ways.	Transport occurs in barges, trucks, or cars; dredge does not transport material. Material disposal occurs in many ways.	Transport occurs in barges, trucks, or cars; dredge does not transport material. Material disposal occurs in many ways.	Transport normally occurs in barges. Dredges equipped with hoppers are limited to material disposal by bottom dumping.
Dredged material density	Approaches in-place density in mud and silt.	Approaches in-place density in mud and silt.	Approaches in-place density in mud and silt.	Approaches in-place density in mud and silt. Approaches dry density in coarser material.
Comments	Approaches dry density in coarser material. The term "dredge" is questionable for this machine, since it is not exclusively built for underwater excavation and is frequently used for material removal above water. It is suitable for all but the hardest material and has a low production for its size.	Approaches dry density in coarser material. Special hard dredge of simple principle. Rudimentary machine can be assembled for temporary service by placing power shovel on spud barge. Low production for size of plant and investment.	This machine is simple in principle. It can be assembled in rudimentary form for temporary service by placing a crane on a barge. It is suitable for all but the hardest materials and has a low production for its size.	Highly developed machine. Not used in United States (other than as part of mining plant), but used extensively in other countries. It is suitable for all but the hardest materials and has a high production for its size.
Simplified outline				

Table 9.1 (cont) Hydraulic Dredges (Mohr, 1974, pp. 72, 73)

Dredge type (1)	Cutterhead dredge (2)	Dustpan dredge (3)	Hopper dredge (4)	Sidecasting dredge (5)
Dredging principle	Material is removed with a rotary cutter (or plain suction inlet in light material) picked up with dilution water by the suction pipe, and transported through the pump and the discharge line. While working, dredge swings around spud toward an anchor. Medium intermittent force opposing swing to side.	Material is removed with water jets, picked up by a wide but shallow suction opening and transported through the pump and the discharge line. While working, dredge is slowly pulled toward two anchored spuds or anchors.	Material is removed and picked up together with dilution water by draghead sliding over bottom (or stationary) and flows through suction piping, pump, and discharge piping into hoppers of vessel.	Material is removed and picked up together with dilution water by draghead sliding over bottom and flows through suction piping, pump, and discharge arm over side of vessel back into the water.
Horizontal working force on dredge	Medium intermittent force opposing swing to side.	Medium constant force opposing forward movement.	Slight constant force opposing forward movement.	Slight constant force opposing forward movement.
Anchoring while working	Two spuds and two swing anchors (one working spud and one walking spud).	Two spuds or anchors secured upstream while working.	Dredge moves under own power to dig a channel or is anchored to dig a hole.	Dredge moves under own power to dig a channel.
Effect of swells and waves	Very sensitive to swells and waves.	Very sensitive to swells and waves.	Little affected by swells and waves.	Little affected by swells and waves.
Material transport	Transport occurs in pipeline. Length of discharge line depends on available power, but can be extended with booster pump units to a total length of several miles. Diluted to an average of 1,200 g/l.	Transport occurs in pontoon supported pipeline to side of dredge. Spoil discharges into water. Booster pump units are not used with this plant.	After material is in hoppers, transport is over any suitable waterway. Material can be bottom dumped or pumped out (if so equipped). Pumpout is similar to pipeline dredge operation.	Transport occurs in pipeline on discharge boom over side of dredge. Material discharges into adjacent water.
Dredged material density	Diluted to an average of 1,200 g/l.	Diluted to an average of 1,200 g/l.	Diluted to an average of 1,200 g/l.	Diluted to an average of 1,200 g/l.
Comments	Highly developed machine with intricate horizontal moving procedure used throughout the world. Suitable for all but very hard materials. High production for size of plant.	Special sand dredge used only in United States in Mississippi River. Floating line is positioned with rudder in discharge stream. High production for size of plant.	Highly developed machine used throughout the world. Suitable for all but very hard materials. Production depends on traveling time to dump and mode of discharge.	Special sand dredge. Sand transport is limited to length of discharge boom. Used in coastal inlets or where material discharge into water is not objectionable. High production for size of plant.
Silhouetted outline				

of European dredging, Hoffman (1980) found the following advances in dredging equipment: 1) electronic navigation by radar and transponder is now used to position the dredge accurately while loading and unloading, 2) sonar mapping of bottom contours is used to estimate dredge quantities and verify job performance, 3) automatic swell compensators have been developed to keep the dredge head on the bottom in heavy weather and waves, 4) self-propelling capabilities have been added to some cutterhead-suction dredges, 5) water jets are being used on the dragheads of newer trailing-suction-hopper dredges to help "fluidize" the sediments, and 6) split-hull hoppers have been developed to permit more rapid dumping.

Most of these improvements are aimed at increasing the production rate of hydraulic dredges on large scale projects. Since dredges in small-craft harbors must be able to work within the confines of slips and piers, large hydraulic dredges are not effective. On these small scale projects, mechanical dredging by clamshell, dragline, or dipper buckets attached to a barge-mounted diesel crane has been standard practice. While such systems have relatively low production rates, they also require low capital investment, are rapidly mobilized, excavate all but the hardest materials, and produce high density dredge spoil. Waterways are most commonly maintained by self-propelled cutterhead-suction dredges (Schubel, Wise and Schoof, 1979). These dredges require less manpower to operate than mechanical dredges but they require larger capital investments, produce low density dredge spoil, and are difficult to transport and mobilize for a project. The selection of a dredge best suited for a particular application depends on the type of material to be handled, its transport distance, disposal method, and some environmental factors that are becoming increasingly important. The cost of a dredging operation is a function of the type

of operation and the disposal method. Hydraulic pipeline operations which can pump dredge spoil up to 3 miles (4.8 km) are generally cheaper than hopper dredging, while "bucket and scow" operations are the cheapest of all (Schubel, Wise, and Schoof, 1979). As a rule-of-thumb, the cost of a hopper or scow disposal is directly proportional to the travel distance.

9.2 PRIMARY AND MAINTENANCE DREDGING

Primary dredging is required in a harbor or waterway before it will be navigable by the deepest draft vessel anticipated. Maintenance dredging on the other hand refers to dredging that may be required in the future to maintain the same depth. It is often not clear when maintenance dredging should be performed. Maintenance dredging should be scheduled so that it does not interfere with peak seasonal traffic and so that the damage caused by dredging and disposal operations is minimized. The months of September through February appear to be the most desirable time of year for maintenance dredging according to Schubel, Wise, and Schoof (1979).

Sediments should not be allowed to accumulate until the deeper draft craft (usually sailboats) become grounded and possibly damaged. Since dredging frequency is directly related to the rate at which sediments collect, it is important to be able to predict when maintenance will be required. The process of sedimentation, commonly referred to as shoaling, depends on many factors such as suspended load, particle size, depth, bottom geometry, water velocity, and flow turbulence. Shoaling rates are usually determined with the aid of a sediment transport budget. Briefly, a sediment transport budget requires balancing volumetric

sediment inflow and outflow over a specific time interval for a given area. Budgeting methods for tidal inlets and estuaries are presented by Bruum (1978) and Ippen (1966).

Increased channel depth is usually the object of new dredging projects. Along with increased depth, channel dredging will change the bottom geometry, decrease the average water velocity, and increase the turbulence on the bottom because of a rougher surface. Since all these variables influence shoaling, a preproject sediment budget will no longer be valid. In the past, a number of procedures for accessing the effect of depth on maintenance requirements have been used. The increase in shoaling rate with deepening has been assumed to be proportional to the percent increase in cross-sectional area, or the percent increase in wetted perimeter. These approaches are based on channel geometry alone and are not reliable. Experience from nearby areas and limited historical dredging data have also been used with somewhat better results (Trawle, 1981). Recently, an analytical method to predict the effect of depth on dredging has been developed by the U.S. Army Engineer Waterways Experiment Station (Trawle, 1981). This method requires more effort than the procedures mentioned earlier, but it is much more reliable and can accommodate the effects of advance maintenance dredging.

9.3 DREDGED MATERIALS AND THEIR DISPOSAL

Dredged materials range from clean sands to fine-grained oozes. Most dredged sand comes from the near-shore zone or from waterways where the water velocity is relatively fast. In most cases, sand should be considered a resource to be exploited instead of wasted. It is used in many phases of coastal construction such as concrete work, beach and dune

nourishment, and as a bearing surface under rubble-mound breakwaters (See Ehrlich and Kulhawy, 1982). Fine-grained sediments consist of silt and clay particles mixed with organic matter to form muds that settle in the quiet waters of harbors and bays. More than 75 percent (by volume) of the materials dredged from harbors and bays bordering Long Island Sound, New York are composed of silt and clay (Schubel, Wise, and Schoof, 1979). Malloy (1980) states that about 87 percent of the material dredged by the U.S. Navy Harbor Maintenance is mud (silty-clay or clayey-silt). The in-place densities of these dredged materials range from 80 pcf (12.5 kN/m^3) for very loose muds to about 125 pcf (19.6 kN/m^3) for sand deposits.

The methods of disposal of dredged materials depends on the type of material, the type of equipment available, the location of the disposal site, and numerous environmental concerns. Some of the alternatives for disposal are offshore dumping, overboard disposal, construction of artificial islands, beach nourishment, and the filling of upland areas. Dredge spoil has been used for fertilizer in the past (mostly in Europe), but this practice is no longer common because the fine-grained sediments that contain the most nutrients are very often contaminated.

An upland disposal site within about 3 miles (4 km) of the dredging site is most economically favorable according to Schubel, Wise, and Schoof (1979). In such a case, the dredge spoil would probably be pumped to a diked containment area through a hydraulic pipeline. There are several disadvantages to such an operation however. Relatively few upland areas adjacent to waterways or harbors are undeveloped, so land acquisition may be very expensive. The containment facilities permanently change the

landscape and have a finite lifespan. They may not be effective in protecting water quality since some of the finer soil particles (carrying the contaminants) can flow over the outlet weirs with the excess water. Finally, the engineering characteristics of most hydraulic fills are poor because of their high water content and weak soil structure. These properties may be improved by draining the deposit and "reworking" it. Saucier (1978) indicates that surface trenching is a cheap and effective way to dewater and densify hydraulic fills.

Beach nourishment is usually accomplished by hydraulic pipeline, but since sand is the only suitable material, containment dikes are not required. Sand is pumped directly onto the beach and settles quickly, allowing the water to run off the shore. The primary reason for beach nourishment is to create or sustain a beach for recreational purposes. Clean sand from nearby maintenance dredging is often used to repeatedly nourish beaches that are not inherently stable. A special case of this situation occurs when jetties are located at river mouths. Sand accumulates on the updrift side of the jetty while the beach or shore on the down-drift side erodes and recedes. If sand is allowed to bypass the jetty, it eventually forms a shoal in the channel. One of the methods of controlling sand bypassing is to dredge the sand and deposit it on the down-drift beach. Figure 9.1 illustrates some common sand bypassing systems. In the absence of a sand bypassing system, deeper sections called "sand traps" are often dredged in the channel where shoaling is expected. To remain functional, these sand traps must be routinely maintained. Jetties and sand bypassing are discussed by Ehrlich and Kulhawy (1982).

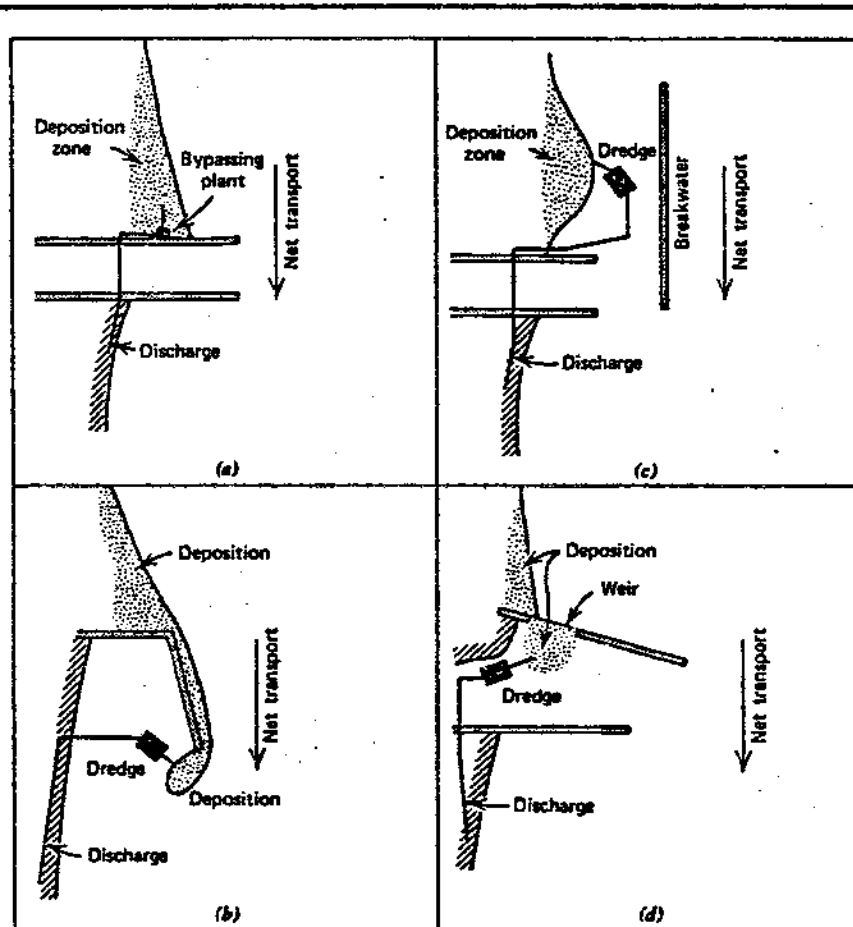

Figure 9.1 Beach Nourishment and Sediment Bypassing
(Sorenson, 1978, p. 205)

Artificial islands are constructed in much the same manner as the diked upland disposal sites. First, a shoal area is outlined by a layer of rubble to form the containment. Then the fill (usually sand) is pumped into the middle by a hydraulic dredge. While fine-grained sediments may also be used to build artificial islands, a layer of sand around the perimeter may be necessary to act as a filter zone. Islands formed by dredged material disposal provide the unique opportunity to create an upland habitat that is environmentally beneficial and has wide public appeal (Saucier, 1978). After placement, the island must be stabilized (dewatered and densified) and planted. Woodhouse, Seneca, and Broome (1974) address the problem of establishing salt marshes on dredge spoil. Schubel, Wise and Schoof (1979) discuss the kinds of dredged material suitable for salt marsh construction, and the mobilization of contaminants associated with these materials by salt marsh plants.

Overboard disposal is the term usually used to describe the discharge of dredged materials in unconfined disposal sites relatively close to the area being dredged (Schubel, Wise, and Schoof, 1979). This method of disposal is usually accomplished by picking up the dredge material with a draghead and pumping it (via a discharge arm) over the side of the vessel and back into the water. This type of dredge is called a "side-caster" (See Table 9.1). Side-casting dredges are limited to sand removal because the discharge of fines produces excessive turbidity.

If the only practical alternative is open-water disposal, the proximity and water depth of the disposal site will govern the choice of dredging/disposal methods (Schubel, Wise, and Schoof, 1979). Hydraulic pipeline dredges have an economical spoil transportation limit of about 3 miles (4 km). If the disposal site is farther away but relatively

shallow, the bucket and scow method would probably be used. Hopper dredging and disposal is most often used when the disposal site is distant and the water depth at the disposal site is greater than about 30 ft. (9 m) (Schubel, Wise, and Schoof, 1979). Since the cost of open-water disposal increases proportionately to the travel distance, the most economical disposal area is closest to the dredging site. Environmental concerns usually favor the more distant disposal areas, however. Saucier (1978) states that extensive deep ocean areas are environmentally more acceptable than are some highly productive continental shelf areas, especially for contaminated materials.

9.4 ENVIRONMENTAL IMPACTS OF DREDGING

Dredging operations of the past usually had economics as the primary performance criterion. With today's increased ecological awareness, however, environmental concerns are rapidly gaining importance. While it is evident that dredging does have some environmental impact, not all of its effects are negative. This section presents some of the advantageous and deleterious effects of dredging followed by a discussion of some of the less obvious items.

In a summary of their work on the environmental effects of dredging, Herbich and Schiller (1974) suggest the following:

A. Advantageous Effects of Dredging

1. removal of polluted bottom sediments for safe storage and/or treatment.
2. re-oxygenation of sediments.
3. increase of the overall water column oxygen content by mixing.

4. resuspension of nutrients to make them available to suspension feeders.
5. removal of dissolved and particulate absorbed pollutants from the water column by tying them up in bottom sediments.
6. modification of flow patterns.

B. Deleterious Effects of Dredging

1. removal of habitats.
2. resuspension of pollutants absorbed to sediments, thus increasing their toxicity.
3. physical damage to organisms.
4. may present a barrier to the movement of fish or other marine life.
5. mortality due to burial of habitats.
6. modification of flow patterns.
7. turbidity.
8. All of the above may affect the smallest of marine organisms directly, thus removing them from the food chain and eventually affecting the food supply of man.

There is no doubt that dredging operations can have a severe impact on marine life. With proper control, however, little damage is caused by dredging. Major effects are physical damage to individual organisms, removal of habitat, and burial because of open-water disposal. Physical damage is minimized by limiting the area that the dredges can operate in. Texas for example now allows dredges to operate no closer than 300 ft. (90 m) from established live oyster reefs (Laycock, 1968). Removal of habitat cannot be avoided. This affects fish more than shellfish because the fish use forests of seaweed for protection. It may take more than a year for sea grasses and seaweed to recolonize dredged areas (Godcharles, 1971).

Dredged materials settle in a rapid jet after being discharged into open water. The coarser materials go directly to the bottom as a density flow while a small percentage (less than 5% of the total mass released) is suspended as a turbid plume. The spoil then spreads (See Figure 9.2) to either side to form a "pancake" that is thicker and denser at the center. Lacking the mobility of fish, shellfish are often caught under this layer of spoil. Saucier (1978) states that the survival of buried organisms is maximized when the type of material disposed of at a site has the same grain size distribution as the natural bottom.

Pollutants will always be found in varying degrees in dredged materials. The impact of these pollutants is measured by its toxicity which is related to the type of contaminant and its concentration. Contaminants are grouped by Schubel, Wise, and Schoof (1979) into several classes as follows:

1. Heavy Metals, including cadmium, mercury, lead, nickel, and chromium.
2. Halogenated hydrocarbons, including such industrial chemicals as PCB's and pesticides like DDT, Aldrin, and Dieldrin.
3. Pathogenic bacteria and viruses.
4. Petroleum hydrocarbons.
5. Other exotic organic and inorganic chemicals.
6. O₂-demanding substances.

These materials are all more easily absorbed by fine-grained sediments than by coarser materials like sands. Treatment of dredged material for contaminants is not generally practical because of the very large volumes, the variable nature of the material involved, and the very low concentra-

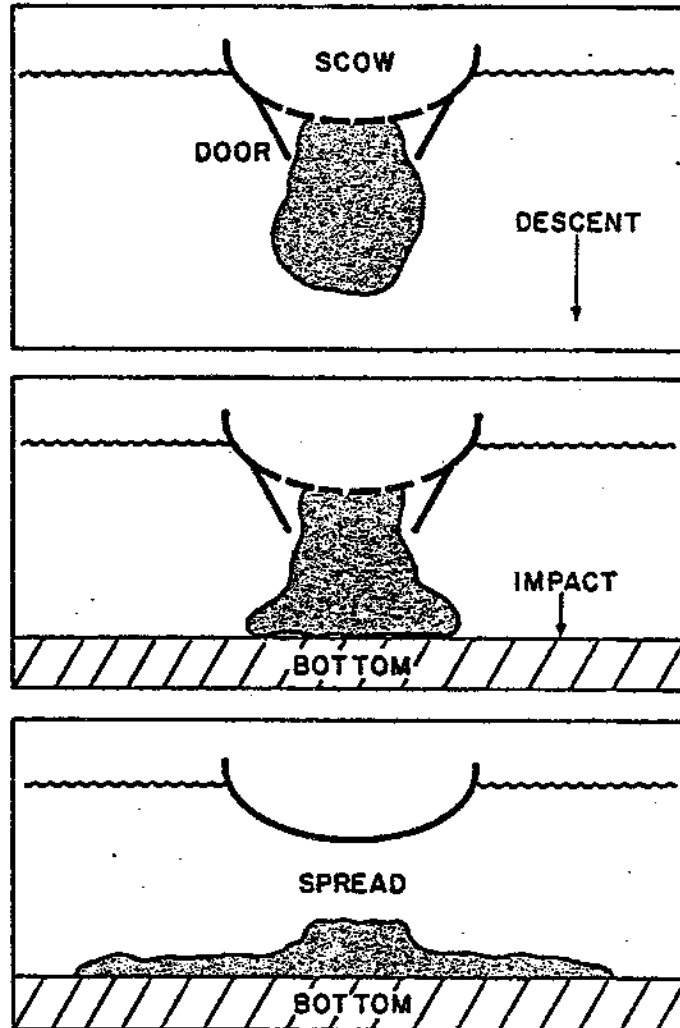

Figure 9.2 Behavior of Dredged Material Released from a Scow (Schubel, Wise and Schoof, 1979, p. 51)

tion of the contaminants (Saucier, 1978).

The process of dredging in itself tends to re-oxygenate sediments. Especially during hydraulic pipeline operations, in-line re-oxygenation appears to be economically and operationally feasible (Saucier, 1978). The rate at which spoil areas are repopulated can be markedly increased by an increase in the dissolved oxygen content of the sediments.

Turbidity is the one most obvious environmental impact of dredging. Turbidity is caused by the resuspension of fines during dredging and disposal. Turbid waters are much worse in appearance to the observer than they are in their impact on aquatic life. Open-water pipeline disposal causes the greatest turbidity of any dredging method, yet less than 5 percent of the total amount of solid material discharged is incorporated in the turbid plume (Schubel, Wise and Schoof, 1979). Concerning regulatory actions of prescribing maximum turbidity levels, Gustafson (1972) states that such actions have been taken "in almost complete ignorance of the degree of damage, if any, and in spite of the fact that wind and tide generated turbidity dwarf those of man's actions." On the effect of turbidity or suspended sediment particles on both water quality and aquatic organisms, Saucier (1978) wrote, "turbidity is primarily a matter of aesthetic impact rather than biological importance." ... "most adult organisms can tolerate turbidity levels and durations far in excess of what dredging and disposal operations produce." One of the beneficial effects of turbidity is that in resuspending bottom sediments, nutrients are provided for fish to feed upon.

9.5 DREDGING PROBLEMS

Dredging operations are subject to problems that adversely affect the operation of coastal facilities. These problems may be categorized in three groups, problems that are directly related to the dredge itself, problems caused by the character of the material to be dredged, and problems dealing with the surrounding structures.

Small craft harbors are not generally large enough to justify purchasing a dredge solely for that project. It is therefore necessary to obtain a dredge from some outside source and have it transported to the marina site. The first problem that arises is the cost and difficulty of moving a dredge that may need to be partially dismantled. Secondly, the dredge type available may not be suited to the material to be dredged, and modifications are necessary to prevent an inefficient operation.

Prior to dredging, the character of the bottom materials is usually determined by drilling a number of test holes or test pits scattered around the area to be dredge. By interpolation, these bore hole logs are used to identify the soil types and their distribution. It is relatively easy however to miss pinnacles of bedrock intrusion or large boulders suspended in a softer matrix. Layton (1979) cites a case where a cutter section hydraulic dredge was contracted to excavate a basin in Northern Puget Sound, Washington. Although tests indicated only silt deposits, the dredge soon encountered boulders that jammed the pump and pipeline, and caused structural damage to the cutter head assembly.

Most coastal structures can be easily damaged by dredging operations. Damage occurs either by physical contact with the structure, or by removing the underlying soil so that the structure becomes unstable. Inner harbor structures such as docks, piers, and wharves are the most

vulnerable since there is little room to maneuver. Bray (1979) states that mechanical dredges are more suitable for keeping close tolerances under such conditions because of their accuracy in dredging to a predetermined depth and their positive digging action. Suction dredges, on the other hand, often overdredge to an excessive amount and can easily cause stability problems at the toe of a sheet pile or gravity wall structure.

Dredging operations also present some other problems that are not so obvious. Dredging alters the shoaling characteristics of a harbor bottom and may result in an increase in the depositional rate. The impact of dredging on the environment because of disruption of habitat at the dredging and disposal sites may also be significant. While these factors are difficult to assess or quantify, environmental impact is an important issue that should not be taken lightly.

9.6 SUMMARY

Dredging is an important aspect of harbor design and maintenance. Dredging is performed to excavate basins or waterways for navigation or to maintain these areas as sedimentation occurs with time. Primary dredging is likely to encounter harder, more consolidated materials, while maintenance dredging must remove soft sediments and debris.

There are two general categories of dredges differentiated by the method of spoil removal, including mechanical and hydraulic processes. Within these categories, dredges are often custom designed using components of various types to meet specific conditions.

Dredged materials are either used as fill to create or maintain adjacent land areas, or they are taken to some external disposal site as a waste product. The use of dredged material for agricultural purposes is

discouraged because of the presence of heavy metal contaminants.

The environmental impacts of dredging include favorable as well as deleterious effects. Dredging both destroys and creates marine life habitat, modifies bottom flow patterns, and influences future sedimentation rates.

Dredging leads to problems related to the dredge equipment, dredge materials removed, adjacent structures, and the environment. Proper planning and control can minimize these problems and ensure a successful operation.

CHAPTER 10

SUMMARY AND CONCLUSIONS

Docks, piers and wharves are coastal structures constructed on the shoreline or waterfront to provide an interface between land and water modes of transportation. These structures are often supplemented with the construction of bulkheads and boat ramps for ease of access from the landside. Breakwaters and jetties provide protection on the seaside and create a calm, sheltered harbor that is easily navigated.

Harbor layout and planning should encompass the inner harbor structures as well as the surrounding protective works. Model studies are a very useful tool during the planning and layout phase to confirm that the coastal processes are as expected and to ensure that the resulting installation will be a functional and financial success.

The "ideal" marina should have a land to water ratio of approximately one to one, with convenient access by land and water. It should be located reasonably close to a center of population and to recreational boating waters to minimize travel time for users. Efficient dock, pier and wharf layout requires proper orientation of these structures for convenient use in the least possible space while providing add-on capabilities for future expansion needs.

The various loads that should be considered during the structural design of docks, piers and wharves may be separated into two broad categories: natural and man-made. Natural loads are those caused by environmental processes and occur in the form of waves, wind, current or ice. Man-made loading conditions include boat impact, and dead and live loads. Although the magnitudes of these loads are dependent on

site specific conditions, wind loads are generally dominant. It is common practice to combine the various loads in a rational manner when determining a structural design load. While it may be technically feasible to build docks, piers or wharves to resist the severe design loads that are caused by exposed locations and heavy storm action, construction and maintenance costs become excessive. Under these conditions, breakwaters and jetties are generally provided to attenuate the environmental loads and create a sheltered berthing area. Catastrophic events such as earthquakes, hurricanes and tsunamis can cause loads that are impractical to consider in routine design. Instead, an emphasis should be placed on early warning and evacuation systems to minimize bodily injury and property damage.

The principal materials used in coastal construction are concrete, steel and wood. Aluminum, wrought iron and various synthetic materials are used less frequently. Most structures are constructed from several different materials since each material has properties that make it suitable for different applications. Material selection for a given application depends on availability, strength, durability and cost. Because of the harsh marine environment, durability may become a more critical design parameter than strength with respect to the sizing of members. Oversizing of structural members is one method of compensating for the loss of section that results from deterioration and corrosion. Additives, preservatives, alloys and coatings are also used to increase material durability.

There are three broad categories of structures used in the construction of docks, piers and wharves. These include solid fill struc-

tures, fixed or pile supported structures, and floating or pontoon supported structures. Small craft harbor facilities are generally a combination of each of these structural types. The trend in modern marina construction is toward the use of a floating berthing area that is accessed by a fixed pier approach. Solid fill walls are used to stabilize the harbor perimeter and provide an abrupt land/water interface.

Solid fill type docks, piers and wharves are constructed of fill that is held in place by a retaining wall. While the anchored bulkhead is the most common wall type, others include the cantilever sheet pile wall, cantilever "L" wall, gabion wall, crib wall, cellular sheet pile wall, concrete caisson wall, and walls supported by relieving platforms. The selection of the appropriate wall type for a given location depends on the project scope, the required depth of water, the consistency of the underlying soils, the loads imposed, and the allowable movement of the wall after completion. Dredging and backfill operations conducted during construction of a solid fill wall must be carefully controlled to avoid damaging the wall.

Docks, piers and wharves that are pile supported are considered fixed structures. They are generally suitable for the construction of berths where the water surface fluctuations do not exceed about 4 ft (1.2 m), the basin depths are less than about 20 ft (6.0 m), and the average user craft are more than 30 ft (9.0 m) in length. The usual structural geometry of a fixed dock or pier starts with a row or "bent" of piles tied together at the top by a pile cap. The bents support longitudinal stringers upon which the decking is laid. Bracing is provided in the

vertical and horizontal planes to create a rigid framework. The long-term performance of such a structure demands prompt maintenance since a loose connection or damaged member may create an artificial hinge that quickly destroys the overall structural integrity of the system.

Pontoons, instead of piles, provide the means of vertical support for floating docks, piers and wharves. Lateral restraint must be provided separately by bracing from the shore, by installing guide piles, or by anchoring with cables to the bottom. Floating docks are generally favored for sites with water level variations greater than about 4 ft (1.2 m), basin depths in excess of 20 ft (6.0 m), and user craft less than about 30 ft (9.0 m) in length. The foam filled shell or pontoon is the building block of the floating dock. These pontoons support a framework of stringers, walers, braces and decking that behaves in a semi-rigid manner. Floating docks are well suited to modular construction and prefabrication.

Utilities and other services have become a necessary part of the successful modern marina. Utilities that are commonly provided at the berth include electrical power and freshwater. Sewage disposal facilities may be provided in the form of a portable holding tank or a fixed pumpout station. In some cases, however, sewage hookups as well as telephone connections are installed at the berths. Fire fighting capabilities and a station for refueling are examples of special services. These systems are subject to many regulations on the federal, state and local level. For proper performance, it is important that utilities and special services not be treated as add-on systems.

Dredging or the removal and disposal of submerged materials is

often required for the creation or maintenance of waterways and harbors. There are two broad categories of dredges distinguished by the method of spoil removal. Mechanical dredges excavate underwater deposits by means of buckets or scoops while hydraulic dredges must reduce the material to a slurry that can be pumped. Dredged materials can range from very fine-grained soils to large boulders, trash and debris. Some of this material may have value as beach or structural fill. Most dredged spoils are considered waste products and are transported to a disposal site. The environmental impacts of dredging include the creation and destruction of marine life habitat, modification of bottom flow patterns, and increasing turbidity levels.

This report has presented guidelines for the planning, layout and design of dock, pier and wharf structures. With the aid of knowledgeable professionals, these guidelines can help to ensure a successful marina installation. It should be noted, however, that there can be no substitute for sound engineering judgment in coping with unanticipated or unusual conditions that are often encountered when building on the waterfront. Several cycles of analysis and design may be necessary before an optimal design is achieved.

BIBLIOGRAPHY

- American Association of Port Authorities (1964), Port Design and Construction, 1st ed., Prepared by Standing Committee IV on Construction and Maintenance, J. M. Kyle, Chairman, Washington, DC, 174 p.
- American Concrete Institute (1977a), "Guide to Joint Sealants for Concrete Structures," Title no. 67-31, ACI Manual of Concrete Practice, Part 3: Products and Processes, Detroit, MI, pp. 504.1-504.48.
- American Concrete Institute (1977b), "Suggested Design of Joints and Connections in Precast Structural Concrete," Title no. 61-51, ACI Manual of Concrete Practice, Part 3: Products and Processes, Detroit, MI, pp. 512.15-512.25.
- American Concrete Institute (1978a), "Recommended Practice for Selecting Proportions for Normal and Heavyweight Concrete (ACI 211.1-77)," Manual of Concrete Practice, Part 1: Materials and Properties of Concrete, Construction Practices and Inspection, Pavements and Slabs, ACI, Detroit, MI, pp. 211.1-211.20.
- American Concrete Institute (1978b), "Recommended Practice for Selecting Proportions for Structural Lightweight Concrete (ACI 211.2-69, revised 1977)," Manual of Concrete Practice, Part 1: Materials and Properties of Concrete, Construction Practices and Inspection, Pavements and Slabs, ACI, Detroit, MI, pp. 211.21-211.40.
- American Institute of Steel Construction (1980), Manual of Steel Construction, 8th ed., Chicago, IL, 674 p.
- American National Standards Institute, Inc. (1979), "American National Standard Specifications and Dimensions for Wood Poles," ANSI O5.1 - 1979, B. Bohannon, Chairman, New York, NY, July, 20 p.
- American Society of Civil Engineers (1975), Wood Structures: A Design Guide and Commentary, Compiled by Task Committee on State-of-the-Art: Wood, Committee on Wood, ASCE, New York, NY, 416 p.
- American Society for Testing and Materials (1980), "Standard Specification for Welded and Seamless Steel Pipe Piles (A252-77a)," Annual Book of ASTM Standards, Part 1, Steel-Piping, Tubing, Fittings, Philadelphia, PA, pp. 173-179.
- American Society for Testing and Materials (1980), "Standard Specification for Structural Steel (A36-77a)," Annual Book of ASTM Standards, Part 4, Steel-Structural, Reinforcing, Pressure Vessel, Railway; Fasteners, Philadelphia, PA, pp. 135-138.
- American Society for Testing and Materials (1980), "Standard Specification for High-Strength Low-Alloy Steel H-Piles and Sheet Piling for Use in Marine Environments (A690-77)," Annual Book of ASTM Standards, Part 4, Steel-Structural, Reinforcing, Pressure Vessel, Railway; Fasteners, Philadelphia, PA, pp. 671-672.

- American Society for Testing and Materials (1980), "Standard Test Method for Soundness of Aggregates by Use of Sodium Sulfate or Magnesium Sulfate (C88-76)," Annual Book of ASTM Standards, Part 14, Concrete and Mineral Aggregates, Philadelphia, PA, pp. 48-53.
- American Society for Testing and Materials (1980), "Standard Specification for Round Timber Piles (D25-79)," Annual Book of ASTM Standards, Part 22, Wood; Adhesives, Philadelphia, PA, pp. 23-26.
- American Society for Testing and Materials (1980), "Standard Method for Establishing Design Stresses for Round Timber Piles (D2899-74)," Annual Book of ASTM Standards, Part 22, Wood; Adhesives, Philadelphia, PA, pp. 826-829.
- American Wood Preservers Institute (1968), "Laterally Unsupported Timber Pile Study," AWPI Publication ML, McLean, VA, 25 p.
- American Wood Preservers Institute (1969), "Improved Standard Designs, Pressure-Treated Timber Crib Walls," AWPI Standard HD, McLean, VA, Jan., 16 p.
- American Wood Preservers Institute (1971), "Bulkheads: Hardware and Fasteners," AWPI Technical Guideline S5, McLean, VA, Oct., 4 p.
- American Wood Preservers Institute (1971), "Treated Timber in Corrosive Environments," AWPI Technical Guideline P3, McLean, VA, 4 p.
- American Wood Preservers Institute (1972), "Practical Formulas for Loads and Movements in Battered Pile Foundations (without a computer)," AWPI Technical Guideline P4, McLean, VA, 3 p.
- American Wood Preservers Institute (1975a), "A Simplified Elastic Analysis for Three-Dimensional Pile Groups," AWPI Technical Guideline P5, McLean, VA, 12 p.
- American Wood Preservers Institute (1975b), "FHA Pole House Construction," 2nd Ed., AWPI Publication PBB, McLean, VA, 32 p.
- American Wood Preservers Institute (1976), "Treated Timber Piling," AWPI Technical Guideline P1, McLean, VA, 15 p.
- American Wood Preservers Institute (1976), "Splicing Treated Timber Piling," AWPI Technical Guideline P2, McLean, VA, 4 p.
- Ashton, G. D. (1974), "Air Bubbler Systems to Suppress Ice," CRREL Special Report 210, Cold Regions Research and Engineering Laboratory, NH, Sept., 35 p.
- Ayers, J. and Stokes, R. (1976), "Simplified Design Methods of Treated Timber Structures for Shore, Beach, and Marina Construction," Miscellaneous Report No. 76-4, U.S. Army Corps of Engineers, Coastal Engineering Research Centre, Ft. Belvoir, VA, Mar., 39 p.

- Beard, R. M. (1980), "Holding Capacity of Plate Anchors," Technical Report R882, Naval Facilities Engineering Command, Civil Engineering Laboratory, Port Hueneme, CA, Oct., 87 p.
- Bekaert Gabions (1977), Product Information Form No. 6M, Terra Aqua Conservation, Reno, NV, Jan., 57 p.
- Bernstein, T. (1979), "Marina Electrical Systems - Lightning Protection," presented at the December 3-5 Conference on The Design of Facilities for Small Craft Harbors and Marinas, Sea Grant Extension Program, held at Boston, MA, 22 p.
- Bertlin, D. P. (1976), "Layout and Design of Floating Piers and Brows," Final Report of the International Commission for Sport and Pleasure Navigation, Permanent International Association of Navigation Congresses, Annex to Bulletin No. 25, Vol. 3, Brussels, Belgium, pp. 15-22.
- Building Officials Conference of America (1978), The BOCA Basic Building Code, 5th Ed., Chicago, IL, 483 p.
- Blanton, W. J. (1979), "Water, Fuel and Sewage Disposal Systems," presented at the Dec. 3-5 Conference on The Design of Facilities for Small Craft Harbors and Marinas, Sea Grant Extension Program, held at Boston, MA, 7 p.
- Brater, E. F., McNow, J. S. and Stair, L. (1958), "Wave Forces on Submerged Structures," Journal of the Hydraulics Division, ASCE, Vol. 84, No. HY6, pp. 1833-1 to 1833-26.
- Bray, R. N. (1979), Dredging: A Handbook for Engineers, 1st edition, Edward Arnold (Publishers) Ltd., London, England, 276 p.
- Browne, R. D. (1980), "Mechanisms of Corrosion of Steel in Concrete in Relation to Design, Inspection and Repair of Offshore and Coastal Structures," Performance of Concrete in Marine Environment, Special Publication SP-65, American Concrete Institute, Detroit, MI, pp. 169-204.
- Bruun, P. (1978), Stability of Tidal Inlets, Elsevier Scientific Publishing Company, New York, NY, 506 p.
- Bureau of Reclamation (1975), Concrete Manual, 9th Ed., U.S. Department of the Interior, Denver, CO, 626 p.
- Buslov, V. (1979), "Durability of Various Types of Wharves," Proceedings, Coastal Structures 79, ASCE, Vol. 1, Alexandria, VA, pp. 1164-1181.
- Chamberlain, C. J. (1977), "Marina Design Problems," Proceedings, First National Boating Facilities Conference and Workshop, Newport, RI, Oct., pp. 53-58.

- Chamberlain, C. J. (1979), "The Marina: Site Requirements, Layout of Facilities and Functions," presented at the Dec. 3-5 Conference on the Design of Facilities for Small Craft Harbors and Marinas, Sea Grant Extension Program, held at Boston, MA, 25 p.
- Chaney, C. A. (1961), 2nd Ed., (1943) 1st. Ed., Marinas - Recommendations for Design, Construction and Maintenance, National Association of Engine and Boat Manufacturers, Inc., Greenwich, CT, 297 p.
- Cheung, F. K.-P. and Kulhawy, F. H. (1981), Analysis, Design and Construction of Pile Foundations in the Coastal Environment, New York Sea Grant Institute, Albany, NY, 277 p.
- Chmura, G. L. and Ross, N. W. (1978), "The Environmental Impacts of Marinas and Their Boats," Marine Memorandum No. 45, University of Rhode Island, Narragansett, RI, pp. 32.
- Committee for Waterfront Structures (1966), Recommendations of the Committee for Waterfront Structures, 3rd Ed., E. Lackner, Chairman of the Committee for Waterfront Structures of the Society for Harbor Engineering and the German Society for Soil Mechanics and Foundation Engineering, Wilhelm, Ernst and Sohn, Berlin, Germany, 134 p.
- Commonwealth of Virginia (1976), "Design Guidelines for Pumpout Facilities and On-shore Facilities at Marinas and Other Places Where Boats are Moored," State Department of Health, Bureau of Sanitary Engineering, Richmond, VA, April, 4 p.
- Cordon, W. A. (1979), Properties, Evaluation and Control of Engineering Materials, McGraw Hill Book Co., New York, NY, 368 p.
- Cummings, E. M. (1957), "Cellular Cofferdams and Docks," Journal of the Waterways and Harbors Division, ASCE, Vol. 83, No. WW3, Sept., pp. 1366-1 to 1366-29.
- Curry, B. L. (1979), "California Marina Design Considerations," presented at the Oct. 22-24, National Marine Manufacturers Association Second National Boating Facilities Conference, held at Berkeley, CA, pp. 34-36.
- Das, M. M. (1969), "Relative Effect of Waves Generated by Large Ships and Small Boats in Restricted Waterways," Report No. Hal - 12 - 9, University of California, Hydraulic Engineering Laboratory, Berkeley, CA, 112 p.
- Davenport, A. G. (1980), "Wind Structure and Wind Climate," Safety of Structures Under Dynamic Loading, Vol. 1, TAPIR Publishers, Norwegian Institute of Technology, Trondheim, Norway, pp. 209-256.

- Dearstyne, S. C. (1969), "Harbor Planning," Part 2 of the "Report on Small Craft Harbors," ASCE Task Committee on Small Craft Harbors, G. G. Treadnell, Chairman, Manuals and Reports on Engineering Practice No. 50, ASCE, New York, NY, pp. 3-45.
- Dodds, R. M. (1971), "Covered Marinas," American Wood Preservers Institute, Publication MJ, McLean, VA, Nov.-Dec., 4 p.
- Dunham, J. W., and Finn, A. A. (1976), "Small Craft Harbors: Design Construction, and Operation," Special Report No. 2, U.S. Army Corps of Engineers Coastal Engineering Research Center, Fort Belvoir, VA, Dec., 375 p.
- Dunham, J. W. (1969), "Inner Harbor Structures," Part 4 of the "Report on Small Craft Harbors," ASCE Task Committee on Small Craft Harbors, G. G. Treadnell, Chairman, Manuals and Reports on Engineering Practice No. 50, ASCE, New York, NY, pp. 87-135.
- Dunn, I. S., Anderson, L. R. and Kiefer, F. W. (1980), Fundamentals of Geotechnical Analysis, John Wiley & Sons, Inc., New York, NY, 414 p.
- Ehrlich, L. A. and Kulhawy, F. H. (1982), Breakwaters, Jetties and Groins: A Design Guide, New York Sea Grant Institute, Albany, NY, 355 p.
- Fisher, J. (1980), "Anchors and Anchoring Theory," Sea Grant Publication MAFS-17, Marine Advisory Service, Florida Cooperative Extension Service, University of Florida, Gainesville, FL, March, 4 p.
- Forest Products Laboratory (1974), "Wood Handbook: Wood as an Engineering Material," Agriculture Handbook No. 72, U.S. Department of Agriculture, Washington, DC, 414 p.
- Galvin, C. J. (1969), "Entrance Design and Wave Attenuation," Appendix to Part 3, "Report on Small Craft Harbors," ASCE Task Committee on Small Craft Harbors, G. G. Treadnell, Chairman, Manuals and Reports on Engineering Practice No. 50, ASCE, New York, NY, pp. 77-85.
- Godcharles, M. F. (1971), "A Study of the Effects of a Commercial Hydraulic Claw Dredge on Benthic Communities in Estuarine Areas," Technical Series No. 1, Board of Conservation, State of Florida, 25 p.
- Greene, C. (1917), Wharves and Piers: Their Design, Construction and Equipment, McGraw-Hill Book Company, Inc., New York, NY, 248 p.
- Gustafson, J. F. (1972), "Beneficial Effects of Dredging Turbidity," World Dredging and Marine Construction, December, pp. 44-52.
- Hale, L. Z. (1980), "Erosion Control of Scour During Construction," Technical Report HL-80-3, U.S. Army Corps of Engineers, Waterways Experiment Station, Vicksburg, MS, in three parts: (1) "Present Design and Construction Practice," Mar., 155 p., (2) "Literature Survey of Theoretical, Experimental, and Prototype Investigations," Aug., 202 p., (3) "Experimental Measurements of Refraction, Diffraction and Current Patterns near Jetties," Sept., 150 p.

- Herbich, J. B. and Schiller, R. E. (1974), "Environmental Effects of Dredging," Proceedings, 5th World Dredging Conference, Wodcon Association, San Pedro, CA, pp. 699-720.
- Hoffman, J. F. (1980), "European Dredging - A State of the Art," Proceedings, Coastal Zone 80, ASCE, Vol. 2, Hollywood, FL, pp. 1621-1637.
- Hubbell, W. D. and Kulhawy, F. H. (1979a), Coastal Construction Materials, New York Sea Grant Institute, Albany, NY, 110 p.
- Hubbell, W. D. and Kulhawy, F. H. (1979b), Environmental Loads for Coastal Structures, New York Sea Grant Institute, Albany, NY, 217 p.
- Ippen, A. T. (1966), Estuary and Coastline Hydrodynamics, McGraw-Hill Book Company, New York, NY, 744 p.
- Keown, M. P. and Dardeau, E. A. (1980), "Utilization of Filter Fabric for Streambank Protection Applications," Technical Report HL-80-12, U.S. Army Corps of Engineers, Waterways Experiment System, Vicksburg, MS, July, 118 p.
- Koelbel, W. H. (1979), "Floating Dockage and Anchoring Systems," presented at the Dec. 3-5 Conference on The Design of Facilities for Small Craft Harbors and Marinas, Sea Grant Extension Program, held at Boston, MA, 21 p.
- Laycock, G. (1968), "Deep in the Mud of Texas," Audubon Magazine, Vol. 70, No. 5, Nov.-Dec., pp. 98-118.
- Layton, J. A. (1979), "Design and Construction of a Curvilinear Marina," Proceedings, Coastal Structures 79, ASCE, Vol. 1, Alexandria, VA, pp. 588-609.
- Leitass, R. (1979), "Wave Damages to Stone Slope Under Marginal Wharves," Proceedings, Coastal Structures 79, ASCE, Vol. 1, Alexandria, VA, pp. 1106-1123.
- Linsley, R. K., Kohler, M. A., and Paulhus, J. L. H. (1975), Hydrology for Engineers, 2nd Ed., McGraw-Hill Book Company, New York, NY, 340 p.
- MacLean, J. D. (1952), Preservative Treatment of Wood by Pressure Methods, Agriculture Handbook 40, U.S. Department of Agriculture, Washington, DC, 160 p.
- Malloy, R. J. (1980), "U.S. Navy Harbor Maintenance Dredging Atlas," Technical Note N-1597, Civil Engineering Laboratory, Naval Construction Battalion Center, Port Hueneme, CA, Dec., 35 p.
- Marine Docks (no date), Marine Docks Product Literature, Division Bero Corporation, Waterloo, NY, 10 p.

- McPartland, J. F., McPartland, J. M., and McPartland, G. I. (1981), National Electrical Code Handbook, 17th edition, McGraw-Hill Book Company, New York, NY, 1185 p.
- Mohr, A. W. (1974), "Development and Future of Dredging," Journal of the Waterways and Harbors Division, ASCE, Vol. 100, No. WW2, May, pp. 69-83.
- Murdock, L. J. and Blackledge, G. F. (1968), Concrete Materials and Practice, 4th edition, Edward Arnold (Publishers) Ltd., London, England, 398 p.
- National Fire Protection Association (1975), "Fire Protection Standard for Boatyards and Marinas," Standard No. 303, Quincy, MA.
- National Fire Protection Association (1977), "Underground Leakage of Flammable and Combustible Liquids," Standard No. 329, Quincy, MA.
- National Fire Protection Association (1980), National Electrical Code 1981, Standards Council, Quincy, MA, 886 p.
- National Fire Protection Association (1981), "Flammable and Combustible Liquids Code," Standard No. 30, Quincy, MA, 145 p.
- National Forest Products Association (1977), "National Design Specification for Wood Construction, Washington, DC, 78 p.
- National Forest Products Association (1978a), "Design Values for Wood Construction," Supplement to the 1977 edition of National Design Specification for Wood Construction, Washington, DC, June, 20 p.
- National Forest Products Association (1978b), Wood Structural Design Data, NFPA, Washington, DC, 240 p.
- New York Sea Grant (1978), "Dry Stack Storage: An Alternative to Wet Slip Expansion," Marine Trades Flyer No. 9, New York Sea Grant Extension, Cornell University, Ithaca, NY, Jan., 6 p.
- Nixon, S., Oviatt, C., and Northby, S. (1973), "Ecology of Small Boat Marinas," Marine Technical Report No. 5, University of Rhode Island, Narragansett, RI, 20 p.
- Noble, H. M. (1964), "Concrete pontoons for Marinas," Symposium on Concrete Construction in Aqueous Environments, Publication SP-8, American Concrete Institute, Detroit, MI, pp. 107-114.
- Patterson, D. (1969), "Pole Building Design," American Wood Preservers Institute, Design Manual PBA, 6th edition, McLean, VA, 48 p.
- Patton, W. J. (1976), Materials in Industry, 2nd edition, Prentice-Hall, Inc., Englewood Cliffs, NJ, 464 p.

- Peck, R. B., Hanson, W. E. and Thornburn, T. H. (1974), Foundation Engineering, 2nd Ed., John Wiley & Sons, Inc., New York, NY, 514 p.
- Permanent International Association of Navigation Congresses (1976), "Final Report of the International Commission for Sport and Pleasure Navigation," Annex to Bulletin No. 25 (Vol. III/1976), PIANC, Brussels, Belgium, 25 p.
- Quinn, A. D. (1972), Design and Construction of Ports and Marine Structures, 2nd Edition, McGraw-Hill Book Company, Inc., New York, NY, 611 p.
- Raichlen, F. (1968), "Motions of Small Boats Moored in Standing Waves," Contract Report H-68-2, U.S. Army Corps of Engineers, Waterways Experiment Station, Vicksburg, MS, August, 158 p.
- Richter, H. P. (1977), Wiring Simplified, 32nd Edition, Park Publishing, St. Paul, MN, 160 p.
- Ross, N. W. (1976), "Marinas: The Environmental Impact," Proceedings, 9th National Conference on Access to Recreational Waters," Oct. 20-23, 1975, Galveston, TX. Published by the Outboard Boating Club of America, Chicago, IL, pp. 33-37.
- Saczynski, T. M. and Kulhawy, F. H. (1982), Analysis, Design, and Construction of Bulkheads in the Coastal Environment, New York Sea Grant Institute, Albany, NY, 325 p.
- Saucier, R. T. (1978), "Dredged Material - Waste Product or Resource," Water Spectrum, Vol. 10, No. 4, Office of the Chief of Engineers, Department of the Army, Washington, DC, Fall, pp. 11-17.
- Schubel, J. R., Wise, W. M. and Schoof, J. (1979), "Questions About Dredging and Dredged Material Disposal in Long Island Sound," Special Report No. 28, Marine Sciences Research Center, SUNY-Stony Brook, NY, 136 p.
- Seymour, R. J. (1977), "Defining the Wave Climate for a Harbor," Proceedings, Ports 77, Vol. II, ASCE, Long Beach, CA, pp. 218-235.
- Sorenson, R. M. (1978), Basic Coastal Engineering, John Wiley & Sons, Inc., New York, NY, 227 p.
- State of California (1971), "California Boating Law," Department of Navigation and Ocean Development, Resources Agency, Sacramento, CA, 141 p.
- State of California (1980), "Layout and Design Guidelines for Small Craft Berthing Facilities," The Resources Agency Department of Boating and Waterways, Sacramento, CA, Jan., 21 p.

- Taylor, R. J. (1980), "Conventional Anchor Test Results at San Diego and Indian Island," Technical Note No. N-1581, Naval Facilities Engineering Command, Civil Engineering Laboratory, Port Hueneme, CA, July, 178 p.
- Taylor, R. and Rocker, K. (1980), "Conventional Anchor Test Results at Guam," Technical Note No. N-1592, Naval Facilities Engineering Command, Civil Engineering Laboratory, Port Hueneme, CA, Oct., 64 p.
- TECO (1978), "Structural Wood Fasteners," TECO Publication No. 101, Timber Engineering Co., Washington, DC, 15 p.
- Terzaghi, K. and Peck, R. B. (1967), Soil Mechanics in Engineering Practice, 2nd ed., John Wiley & Sons, Inc., New York, NY, 729 p.
- Texas A & M University (1971), "Port and Harbor Development System," Phase 1 - Design Guidelines, Work Report TAMU-SC-71-216, Architecture Research Center, College Station, TX, Aug., 140 p.
- Timber Engineering Company (1956), Timber Design and Construction Handbook, F. W. Dodge Corporation, New York, NY, 622 p.
- Tobiasson, B. O. (1979), "Pilings and Fixed Piers," presented at the Dec. 3-5 Conference on The Design of Facilities for Small Craft Harbors and Marinas, Sea Grant Extension Program, held at Boston, MA, 21 p.
- Trawle, M. J. (1981), "Effects of Depth on Dredging Frequency," Technical Report H-78-5, Hydraulics Laboratory, U.S. Army Engineer Waterways Experiment Station, Vicksburg, MS, July, 133 p.
- Treadwell, G. T. and Kycek, R. V. (1971), "Regional Application of ASCE Manual No. 50," Journal of the Waterways, Harbors, and Coastal Engineering Division, ASCE, Vol. 97, No. WW1, Feb., pp. 123-130.
- U.S. Army Corps of Engineers (1963), "Design of Breakwaters and Jetties," Engineer Manual 1110-2-2904, Washington, DC, Apr., 24 p.
- U.S. National Bureau of Standards (1970), "American Softwood Lumber," Product Standard PS 20-70, Board of Review of the American Lumber Standards Committee, Washington, DC, 26 p.
- Van Blancom, R. A. (1970), "Pacific Coast Marinas," AWPI Marine Structures MC, McLean, VA, 8 p.
- Webster's New World Dictionary (1976), Second College Edition, B. Guralnik, Ed., William Collins and World Publishing Co., Inc., New York, NY, 1962 p.
- Winzler and Kelly Consulting Engineers, Inc. (1979), "Engineering Study of Concrete Berthing Systems," J. R. Winzler, Director, Eureka, CA, Jan., 114 p.

- Woodhouse, W. W., Seneca, E., and Broome, S. W. (1974), "Establishing Salt Marsh on Dredge Spoil," Proceedings, World Dredging Conference, Wodcon Association San Pedro, CA, pp. 51-78.
- Wortley, C. A. (1978), "Ice Engineering Guide for Design and Construction of Small-Craft Harbors," Advisory Report #WIS-SG-78-417, University of Wisconsin Sea Grant College Program, Madison, WI, May, 132 p.
- Wortley, C. A. (1979), "Design Considerations for Northern Marinas," Proceedings, Second National Boating Facilities Conference, held at Berkeley, CA, Oct. 22-24, pp. 21-27.
- Wortley, C. A. (1981), "Ice Engineering Design of Marine Piling and Piers," Preprint 81-508, ASCE, St. Louis, MO, Oct., 14 p.

APPENDIX A

Small Craft Berthing Facilities,
Layout

State of California, 1980

pp. 3-9, 12

II-Design Criteria

A. WATER AREAS

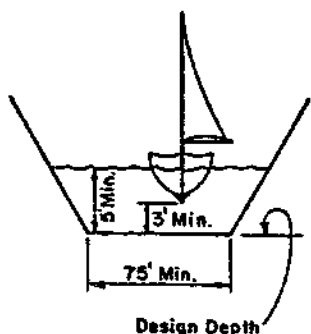

1. CHANNELS - ENTRANCE

- a. Minimum Width: 75 ft. at design depth.
- b. Minimum Depth: 3 ft. below deepest draft vessel anticipated to be berthed in harbor, or 5 ft., whichever is greater. Design depths shall consider anticipated wave action and rate of siltation.

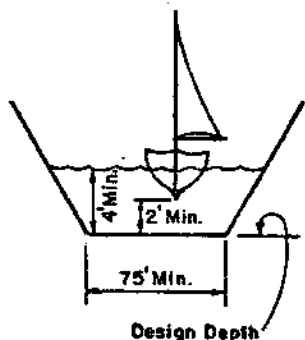

2. CHANNELS - INTERIOR

- a. Minimum Width: 75 ft. at design depth.
- b. Minimum Depth: 2 ft. below deepest draft vessel anticipated to be berthed in harbor, or 4 ft., whichever is greater.



3. FAIRWAYS

a. Minimum Width:

- (1) 1.75 times length of longest berth where berths are perpendicular to the fairway.

$$L_b = \text{length of fingerfloat}$$

- (2) 1.50 times length of longest boat where boats are berthed parallel to the fairway.

$$l_b = \text{length of boat (LOA)}$$

b. Minimum Depths:

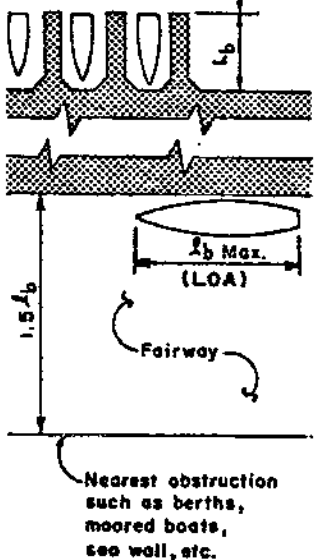

Berth Length	Minimum Depth	
	Power	Sail
up to 25'	4'	4'
35'	6'	6'
45'	6'	6'
55'	8'	8'
65'	8'	10'

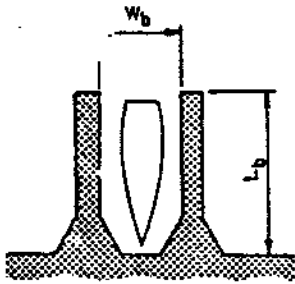

Single Berth

Example: for a single powerboat berth 54' long:
 $W_b = 8 \ln 54 - 14$
 $= 8 \times 3.99 - 14$
 $= 17.9'$

Example: for a single sailboat berth 54' long:
 $W_b = \frac{54}{5} + 5.5 - (54 - 40) \cdot 0.075$
 $= 10.8 + 5.5 - 1.05$
 $= 15.3'$

4. BERTHS - SINGLE

- a. Minimum water depth: Same as for fairways
- b. Minimum width: L_b = length of berth (fingerfloat)

W_b = width of berth
 = beam of boat @ waterline + 2 ft.

	POWERBOATS	SAILBOATS
Recommended for Design Work	$W_b = 8 \ln L_b - 14'$	$W_b = 6.5 \ln L_b - 10.5'$
Recommended for Preliminary Layout and Planning Work	$W_b = \frac{L_b}{4} + 6' - R_p$ $R_p = 0.1$ ft. for each foot of berth length over 40 feet.	$W_b = \frac{L_b}{5} + 5.5' - R_s$ $R_s = 0.075$ ft. for each foot of berth length over 40 feet.

Note: See Page 5 for table of recommended berth widths.

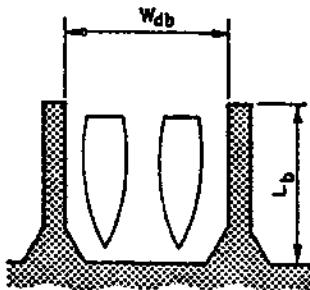

Double Berth

5. BERTHS - DOUBLE

- a. Minimum water depth: same as fairways and singles.
- b. Minimum width:

W_{db} = width of double berth (ft)

$$W_{db} = W_b \times 2 \text{ (see 4b above)}$$

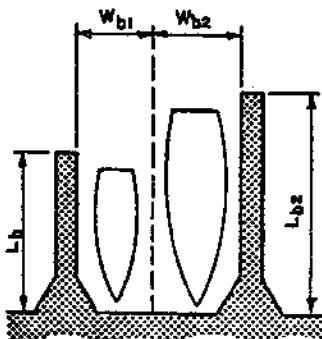

Double Berth (different lengths)

- c. Where double berths consist of two berths of different lengths, the double berth width (W_{db}) will be equal to the sum of the two single berth widths:

$$W_{db} = W_{b1} + W_{b2}$$

- d. Where it is desired to convert a double berth into two single berths by installing a fingerfloat down the center, additional width must be provided for the fingerfloat. Encroachment upon the berthing space will not be permitted.

TABLE I
RECOMMENDED SINGLE BERTH WIDTHS*

"L" Berth Length (Feet)	ln L	POWERBOATS		SAILBOATS	
		$W_b = 8 \ln L - 14$ ** (Feet)	Recommended Widths *** (Feet)	$W_b = 6.5 \ln L - 10.5$ ** (Feet)	Recommended Widths *** (Feet)
16	2.77	8.2	8.5	7.5	7.5
18	2.89	9.1	9.5	8.3	8.5
20	3.00	10.0	10.0	9.0	9.0
22	3.09	10.7	11.0	9.6	10.0
24	3.18	11.4	11.5	10.2	10.5
26	3.26	12.1	12.5	10.7	11.0
28	3.33	12.7	13.0	11.2	11.5
30	3.40	13.2	13.5	11.6	12.0
32	3.47	13.7	14.0	12.0	12.0
34	3.53	14.2	14.5	12.4	12.5
36	3.58	14.7	15.0	12.8	13.0
38	3.64	15.1	15.5	13.1	13.5
40	3.69	15.5	15.5	13.5	13.5
42	3.74	15.9	16.0	13.8	14.0
44	3.78	16.3	16.5	14.1	14.5
46	3.83	16.6	17.0	14.4	14.5
48	3.87	17.0	17.0	14.7	15.0
50	3.91	17.3	17.5	14.9	15.0
52	3.95	17.6	18.0	15.2	15.5
54	3.99	17.9	18.0	15.4	15.5
56	4.03	18.2	18.5	15.7	16.0
58	4.06	18.5	18.5	15.9	16.0
60	4.09	18.8	19.0	16.1	16.5
62	4.13	19.0	19.0	16.3	16.5
64	4.16	19.3	19.5	16.5	16.5
66	4.19	19.5	19.5	16.7	17.0
68	4.22	19.8	20.0	16.9	17.0
70	4.25	20.0	20.0	17.1	17.5
72	4.28	20.2	20.5	17.3	17.5
74	4.30	20.4	20.5	17.5	17.5
76	4.33	20.6	21.0	17.6	18.0
78	4.36	20.9	21.0	17.8	18.0
80	4.38	21.1	21.5	18.0	18.0

* For double berth widths, multiply by two.

** These equations were developed by Cal Boating on an empirical basis via field observation and measurements, and review of boat manufacturers specifications on length and beam of power and sailboats typically found in California marinas and harbors.

*** Recommended widths are rounded "up" to the nearest half foot.

Note: To convert feet to meters, multiply by 0.3048.

TABLE II-A
BERTHING LAYOUT PLANNING DATA FOR SINGLE BERTHS

Fingerfloat Width (Feet)	"L _b " Length of Berth (Feet)	POWERBOATS			SAILBOATS		
		①	②	③	④	⑤	⑥
		Total Berth Area (Ft ²)	Actual Deck Area (Ft ²)	Berths per Acre	Total Berth Area (Ft ²)	Actual Deck Area (Ft ²)	Berths per Acre
F = 2.5'	16	352.5	72.0	123.6	330.7	70.1	131.7
	18	427.1	79.9	102.0	396.4	77.4	109.9
	20	504.9	87.4	86.3	464.6	84.4	93.6
F = 3.0'	22	607.5	107.2	71.7	557.2	103.8	78.2
	24	692.4	115.3	62.9	631.6	111.5	69.0
	26	779.6	123.2	55.9	707.8	119.0	61.5
	28	869.0	131.0	50.1	785.8	126.5	55.4
	30	960.4	138.6	45.4	865.5	133.8	50.3
	32	1053.7	146.2	41.3	946.7	141.1	46.0
	34	1148.8	153.6	37.9	1029.4	148.3	42.3
F = 4.0'	36	1316.1	200.0	33.1	1183.9	194.4	36.8
	38	1418.2	209.3	30.7	1273.0	203.4	34.2
	40	1521.9	218.5	28.6	1363.3	212.4	32.0
	42	1626.9	227.7	26.8	1454.7	221.4	29.9
	44	1733.4	236.8	25.1	1547.3	230.3	28.2
	46	1841.1	245.9	23.7	1641.0	239.2	26.5
	48	1950.2	254.9	22.3	1735.6	248.0	25.1
	50	2060.4	263.9	21.1	1831.3	256.8	23.8
	52	2171.8	272.8	20.1	1927.9	265.5	22.6
	54	2284.3	281.7	19.1	2025.4	274.3	21.5
	56	2397.9	290.6	18.2	2123.8	283.0	20.5
	58	2512.5	299.5	17.3	2223.0	291.7	19.6
60	2628.2	308.3	16.6	2323.1	300.3	18.8	
F = 5.0'	62	2864.0	382.1	15.2	2543.2	374.0	17.1
	64	2985.3	392.8	14.6	2648.5	384.6	16.4
	66	3107.6	403.6	14.0	2754.6	395.2	15.8
	68	3230.7	414.3	13.5	2861.4	405.8	15.2
	70	3354.6	425.0	13.0	2969.0	416.3	14.7
	72	3479.4	435.6	12.5	3077.2	426.9	14.2
	74	3605.1	446.3	12.1	3186.0	437.4	13.7
	76	3731.5	456.9	11.7	3295.5	447.9	13.2
	78	3858.7	467.6	11.3	3405.7	458.5	12.8
	80	3986.6	478.2	10.9	3516.4	468.9	12.4

Note: Numbers in circles refer to equations on page 7.

(SUPPORT DATA FOR TABLE II-A)

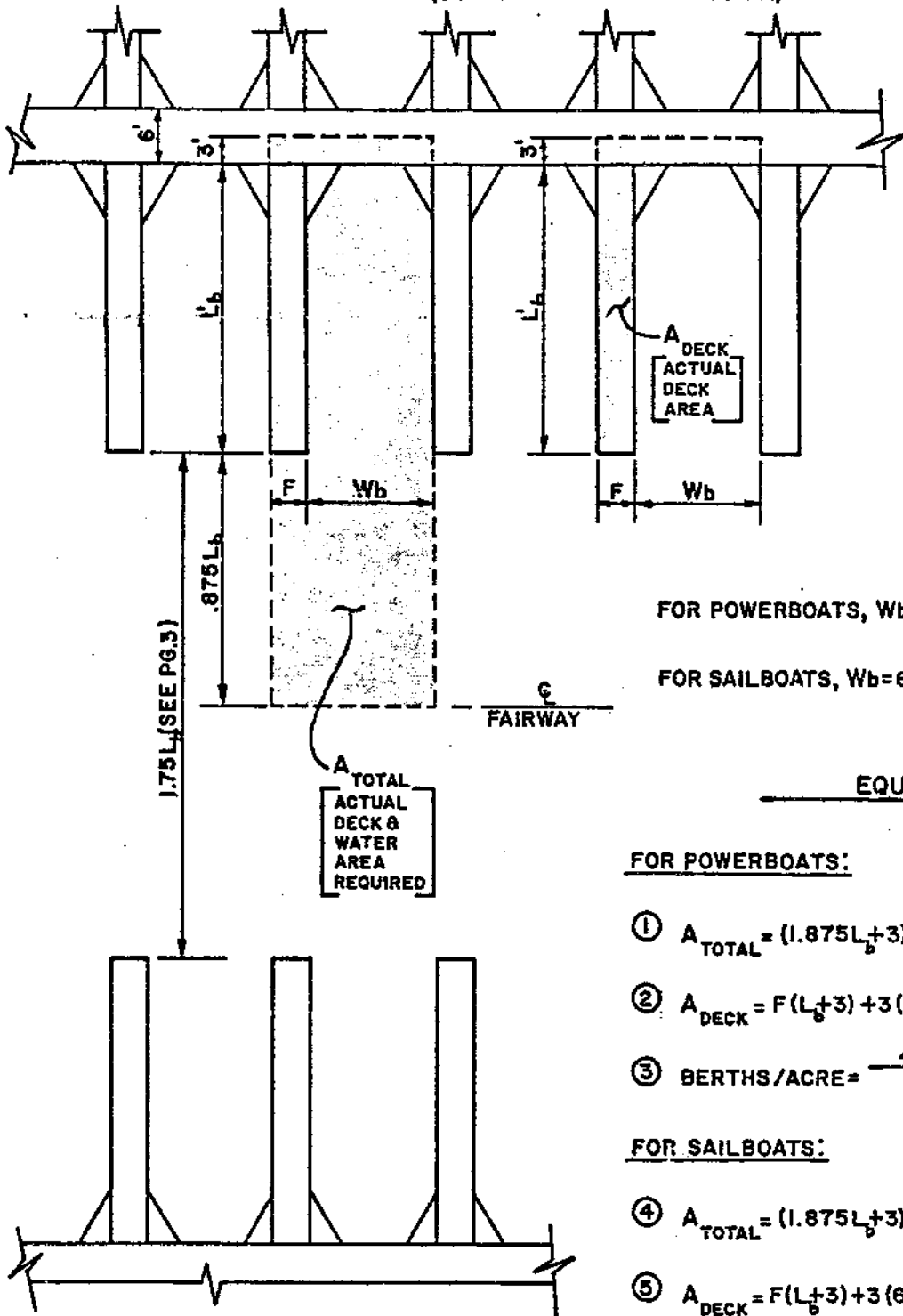

MINIMUM VALUES FOR "F"
(SEE PAGE 12)

L	F
UP TO 20'	2.5'
21' TO 35'	3.0'
36' TO 60'	4.0'
61' & UP	5.0'

FOR POWERBOATS, $W_b = 8 \ln L_b - 14$
 FOR SAILBOATS, $W_b = 6.5 \ln L_b - 10.5$ } SEE PG. 5

EQUATIONS

FOR POWERBOATS:

- ① $A_{TOTAL} = (1.875L_b + 3)(F + 8 \ln L_b - 14)$
- ② $A_{DECK} = F(L_b + 3) + 3(8 \ln L_b - 14)$
- ③ $BERTHS/ACRE = \frac{43560}{①}$

FOR SAILBOATS:

- ④ $A_{TOTAL} = (1.875L_b + 3)(F + 6.5 \ln L_b - 10.5)$
- ⑤ $A_{DECK} = F(L_b + 3) + 3(6.5 \ln L_b - 10.5)$
- ⑥ $BERTHS/ACRE = \frac{43560}{④}$

NOTE: The equations are based on the assumption that main walkways are 6 feet wide (see pg.12)

TABLE III-A
BERTHING LAYOUT PLANNING DATA FOR DOUBLE BERTHS

Fingerfloat Width (Feet)	"L _b " Length of Berth (Feet)	POWERBOATS			SAILBOATS		
		⑦	⑧	⑨	⑩	⑪	⑫
		Total Berth Area (Ft ²)	Actual Deck Area (Ft ²)	Berths per Acre	Total Berth Area (Ft ²)	Actual Deck Area (Ft ²)	Berths per Acre
F = 2.5'	16	311.2	48.3	140.0	289.5	46.3	150.5
	18	381.2	53.6	114.3	350.5	51.1	124.3
	20	454.2	58.6	95.9	414.0	55.7	105.2
F = 3.0'	22	541.1	69.7	80.5	490.8	66.3	88.8
	24	620.4	74.8	70.2	559.6	71.0	77.8
	26	702.0	79.7	62.1	630.2	75.5	69.1
	28	785.7	84.5	55.4	702.6	80.0	62.0
	30	871.5	89.1	50.0	776.6	84.3	56.1
	32	959.2	93.7	45.4	852.2	88.6	51.1
	34	1048.7	98.1	41.5	929.2	92.8	46.9
F = 4.0'	36	1175.1	122.0	37.1	1042.9	116.4	41.8
	38	1269.7	127.3	34.3	1124.5	121.4	38.7
	40	1365.9	132.5	31.9	1207.3	126.4	36.1
	42	1463.4	137.7	29.8	1291.2	131.4	33.7
	44	1562.4	142.8	27.9	1376.3	136.3	31.6
	46	1662.6	147.9	26.2	1462.5	141.2	29.8
	48	1764.2	152.9	24.7	1549.6	146.0	28.1
	50	1866.9	157.9	23.3	1637.8	150.8	26.6
	52	1970.8	162.8	22.1	1726.9	155.5	25.2
	54	2075.8	167.7	21.0	1816.9	160.3	24.0
	56	2181.9	172.6	20.0	1907.8	165.0	22.8
	58	2289.0	177.5	19.0	1999.5	169.7	21.8
60	2397.2	182.3	18.2	2092.1	174.3	20.8	
F = 5.0'	62	2565.9	219.6	17.0	2245.0	211.5	19.4
	64	2677.8	225.3	16.3	2341.0	217.1	18.6
	66	2790.7	231.1	15.6	2437.8	222.7	17.9
	68	2904.4	236.8	15.0	2535.2	228.3	17.2
	70	3019.0	242.5	14.4	2633.3	233.8	16.5
	72	3134.4	248.1	13.9	2732.2	239.4	15.9
	74	3250.7	253.8	13.4	2831.7	244.9	15.4
	76	3367.7	259.4	12.9	2931.8	250.4	14.9
	78	3485.5	265.1	12.5	3032.6	256.0	14.4
80	3604.1	270.7	12.1	3133.9	261.4	13.9	

Note: Numbers in circles refer to equations on page 9.

TABLE III-B
(SUPPORT DATA FOR TABLE III-A)

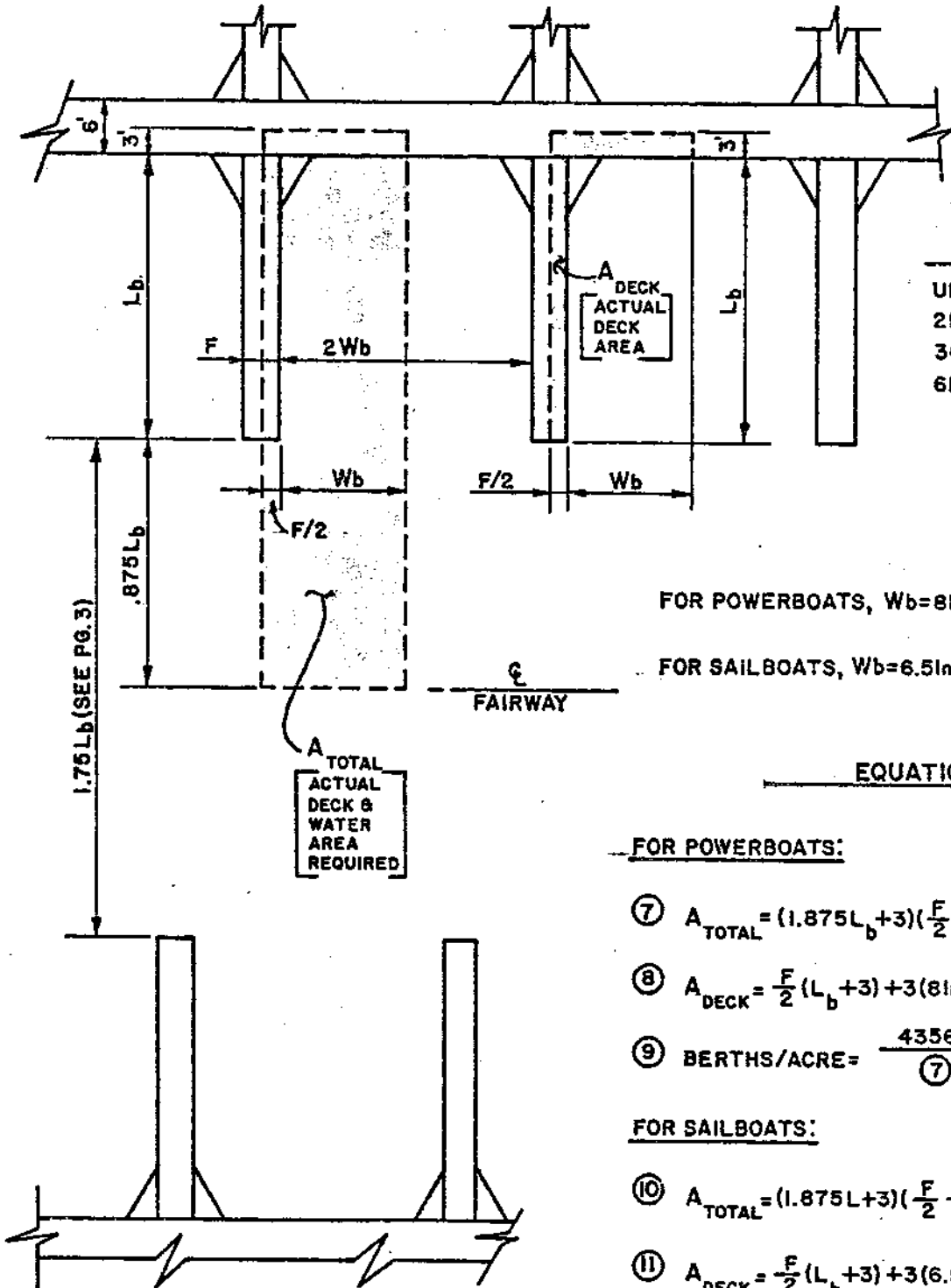

MINIMUM
VALUES FOR "F"
(SEE PAGE 12)

L	F
UP TO 20'	2.5'
21' TO 35'	3.0'
36' TO 60'	4.0'
61' & UP	5.0'

FOR POWERBOATS, $W_b = 8 \ln L_b - 14$ } SEE PG. 5
 FOR SAILBOATS, $W_b = 6.5 \ln L_b - 10.5$ }

EQUATIONS

FOR POWERBOATS:

⑦ $A_{TOTAL} = (1.875L_b + 3) \left(\frac{F}{2} + 8 \ln L_b - 14 \right)$

⑧ $A_{DECK} = \frac{F}{2} (L_b + 3) + 3(8 \ln L_b - 14)$

⑨ $BERTHS/ACRE = \frac{43560}{⑦}$

FOR SAILBOATS:

⑩ $A_{TOTAL} = (1.875L_b + 3) \left(\frac{F}{2} + 6.5 \ln L_b - 10.5 \right)$

⑪ $A_{DECK} = \frac{F}{2} (L_b + 3) + 3(6.5 \ln L_b - 10.5)$

⑫ $BERTHS/ACRE = \frac{43560}{⑩}$

NOTE: The equations are based on the assumption that main walkways are 6 feet wide (see pg. 12)

C. FLOATING STRUCTURES

1. DIMENSIONS

a. Marginal Walkways

- (1) When serving main walkways which do not have individual gangways, the minimum unobstructed width shall be 8 ft.

- (2) When serving main walkways which have individual gangways, the minimum width shall be 6 ft.

b. Main Walkways

- (1) Minimum unobstructed width shall be 6 ft.
 (2) Maximum length shall be 750 ft.

c. Fingerfloats

- (1) For berths up to 20 ft. long, the minimum width shall be 2.5 ft.
 (2) For berths between 21 and 35 ft. long, the minimum width shall be 3 ft.
 (3) For berths between 36 and 60 ft. long, the minimum width shall be 4 ft.
 (4) For berths longer than 60 ft., the minimum width shall be 5 ft.
 (5) Tie-down cleats shall be provided as required. However, not less than two (2) cleats shall be provided on each side of each fingerfloat. One (1) cleat per berth shall be provided on the main walkway.

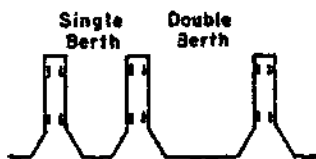
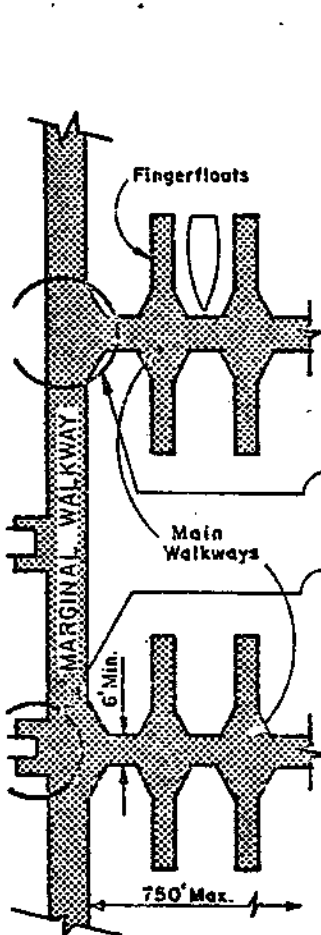

Typical Clear Arrangements

